



CATALOGO GENERALE

2021





SOMMARIO

Contents . Sommaire . Inhaltsverzeichnis .
Sumario . Содержание .

Produzione italiana	4	Due spessori per progetti senza compromessi	10
Made in italy Production italienne Italienische Produktion Producción Italiana Итальянское производство		Two different thicknesses for uncompromising designs. Deux épaisseurs pour des projets sans compromis. Zwei Stärken für Entwürfe ohne Kompromisse. Dos espesores para proyectos sin compromisos. Две толщины для бескомпромиссных проектов.	
La gamma dei formati	6	Top e piani: il design integrato	12
Range of sizes La gamme des formats Die Palette der Formate La gama de los formatos Предлагаемый ассортимент форматов		Tops and floors: integrated design. Dessus et plans : le design intégré. Arbeitsplatte und einlegeböden. Das integrierte design. Encimeras y planos: el diseño integrado. Столешницы и полки: интегрированный дизайн.	
		INDOOR, OUTDOOR: nuovi concetti di arredo e di design	14
		INDOOR, OUTDOOR: new concepts in furnishings and design. INTÉRIEUR, EXTÉRIEUR : de nouveaux concepts de décoration et de design. INNENBEREICH, AUSSENBEREICH: neue Konzepte der Einrichtung und des Designs. INTERIORES, EXTERIORES: nuevos conceptos para mobiliario y diseño. ВНУТРИ И СНАРУЖИ: новые концепции оформления и дизайна.	
		Apri a nuove interpretazioni di progetto	15
		Opens doors to new design insights. Permet de nouvelles interprétations de projet. Öffnet sich neuen Interpretationen des Entwurfs. Abre a nuevas interpretaciones de proyecto. Открывает новые способы интерпретации проекта.	
		Dal dire al fare, dall'idea al prodotto	16
		From words to actions, idea to product. De la parole aux actes, de l'idée au produit. Von Sagen zum Tun, von der Idee zum Produkt. Del decir al hacer, de la idea al producto. От слов - к делу, от идеи - к изделию.	
		Facciate ventilate e incollate	28
		Direct-bonded external wall tiles and curtain walls Façades ventilées et collées Hinterlüftete und verklebte Fassaden Fachadas ventiladas y encoladas Вентилируемые и наклеиваемые фасады	

Extra Application - 9

INDICE PER COLLEZIONE

Collection index . Index par collection .
Inhaltsverzeichnis nach Kollektionen .
Índice de colecciones . Указатель по коллекциям .

Marmo e Pietra - 37

Marble & Stone . Marbres et Pierres .
Marmore und Steine . Mármoles y Piedras .
Мрамор и Камень .

AESTHETICA HEGEL.....	38
AESTHETICA WILDE.....	50
ARDESIA.....	62
AZUL MACAUBA.....	70
BARDIGLIO CENERE.....	82
BRONZE AMANI.....	94
CALACATTA.....	102
COPACABANA DUKE.....	116
COPACABANA EMPEROR.....	126
COPACABANA PRINCESS.....	136
CREMA MARFIL.....	146
C-STONE.....	158
LASA.....	166
NAUTILUS.....	178
NERO BELVEDERE.....	186
ONICE SERPENTINO.....	196
ONICE SMERALDO.....	206
PIRENEI.....	214
PORTORO.....	222
STATUARIO.....	232
STATUARIO SPLENDEnte.....	246
TAJ MAHAL.....	260
TORTOISE.....	268
TRAVERTINO CLASSIC.....	276
WHITE MACAUBA.....	288

Materico - 299

Textured . Matériqúe .
Materisch . Matérico .
Фактурная поверхность .

ABSOLUTE.....	300
CITY.....	314
DISTRICT.....	322
METAL.....	338
SKYLINE.....	356

Design - 381

Design . Design . Design .
Diseños . Дизайн .

SCRATCH.....	382
--------------	-----

AVA Store - 405

LAVABO FUKSAS	406
Washbasin Vasque Waschbecken Fregadero Умывальник	

LAVABO RETTANGOLARE FUKSAS	406
Rectangular washbasin Vasque rectangulaire Rechteckiger Waschbecken Fregadero rectangular Прямоугольный умывальник	

LAVABO DOPPIO FUKSAS	407
Double washbasin Vasque double Doppelwaschbecken Fregadero doble Двойной умывальник	

TOP CUCINA	408
Kitchen top Plan de travail cuisine Arbeitsplatte der Küche Encimera cocina Кухонная столешница	

TAVOLO	410
Table Table Tisch Mesa Стол	

TAVOLO OVALE	411
Oval-shaped table Table de forme ovale Ovaler Tisch Mesa ovalada Овальный стол	

LAVABO	412
Washbasin Vasque Waschbecken Fregadero Умывальник	

LAVABO DOPPIO	413
Double washbasin Vasque double Doppelwaschbecken Fregadero doble Двойной умывальник	

PIATTO DOCCIA CON RIVESTIMENTO	414
Shower base with wall tile Receveur de douche avec revêtement Duschwanne mit Wandbelag Plato ducha con paredes Душевой поддон и облицовки стен	

Parte Tecnica - 417

Technical section . Partie technique .
Technischer Teil . Parte técnica .
Технический раздел .

Finiture delle Superfici	418
Surface finishes Finitions des Surfaces Feinbearbeitung der Oberflächen Acabados de las superficies Отделки поверхностей	

Tante facce tutte differenti	418
Endless looks, all different De nombreuses facettes toutes différentes Viele verschiedene Seiten Tantas caras, todas diferentes Множество лиц, все разные	

La stuoia	419
Fiber glass mesh La fibre de verre Glasfasernetz La estera Сетка из стекловолокна	

Imballi	419
Package Emballage Verpackung Embalajes Упаковка	

Outdoor 20 mm	420
----------------------------	-----

Caratteristiche Tecniche	424
Technical features Caracteristiques techniques Technische Eigenschaften Características técnicas Технические характеристики	

Certificazioni	425
Certifications Certifications Zertifikate Certificaciones Сертификация	

Produzione italiana

Made in Italy
Production italienne
Italienische Produktion
Producción Italiana
Итальянское производство

La Fabbrica storicamente ha sempre pensato "il bello" e disegna ceramiche per i brand Ava e La Fabbrica guidata dai concetti di bellezza e di eleganza tipici del Made in Italy.

La fantasia delle grafiche e la cura di ogni singolo dettaglio (materia, colore, struttura, forma, imballo, servizio, comunicazione, merchandising) sono accompagnate da una elevata attenzione alla qualità di realizzazione delle piastrelle e delle lastre La Fabbrica e Ava.

L'innovazione di prodotto (bello, unico, affidabile, distintivo) è frutto della stretta sinergia tra i diversi reparti di La Fabbrica quali R&D, marketing, produzione, qualità, che trovano spesso ispirazione anche grazie alla collaborazione con importanti architetti e designer di fama mondiale, quali Doriana e Massimiliano Fuksas e Massimo Iosa Ghini.

Historiquement, La Fabbrica a toujours pensé « le beau » et conçoit des céramiques pour les marques Ava et La Fabbrica en s'inspirant des concepts de beauté et d'élegance typiques du Made in Italy.

La fantaisie du graphisme et le soin apporté à chaque détail (matière, couleur, structure, forme, emballage, service, communication, merchandising) s'accompagnent d'une grande attention à la qualité de réalisation des carreaux et des dalles La Fabbrica et Ava.

L'innovation du produit (beau, unique, fiable, distinctif) est le résultat de l'étroite synergie entre les différents départements de La Fabbrica tels que la R&D, le marketing, la production, la qualité dont l'inspiration provient également de la collaboration avec d'importants architectes et designers de renommée mondiale, tels que Doriana et Massimiliano Fuksas et Massimo Iosa Ghini.

Historically, La Fabbrica has always built ceramics for the Ava and La Fabbrica brands on the notion of "beauty" and designs, guided by the concepts of beauty and elegance which are typical of Italian-made products.

The fantasy of the graphics and the attention to every single detail (material, colour, structure, shape, packaging, service, communication, merchandising) are accompanied by a high level of attention to the quality of the production of La Fabbrica and Ava tiles and slabs.

Product innovation (beautiful, unique, reliable, distinctive) is the result of the close synergy between the different departments of La Fabbrica, such as R&D, Marketing, Production and Quality, which often find inspiration also thanks to the collaboration with important architects and renowned global designers, such as Doriana and Massimiliano Fuksas and Massimo Iosa Ghini.

Traditionell hat La Fabbrica immer an „das Schöne“ gedacht und entwirft Keramik für die Marken Ava und La Fabbrica, die sich an den für das Made in Italy typischen Konzepten von Schönheit und Eleganz orientiert.

Die Fantasie bei den Grafiken und die Sorgfalt bei jedem einzelnen Detail (Material, Farbe, Struktur, Form, Verpackung, Service, Kommunikation, Merchandising) werden von einem hohen Maß an Aufmerksamkeit hinsichtlich der Qualität bei der Herstellung der Fliesen und Platten von La Fabbrica und Ava begleitet.

Die Produktinnovation (schön, einzigartig, zuverlässig, unverwechselbar) ist das Ergebnis des engen Zusammenwirkens zwischen den verschiedenen Abteilungen von La Fabbrica, wie F&E, Marketing, Produktion und Qualität, die häufig auch durch die Zusammenarbeit mit bedeutenden Architekten und Designern mit Weltruhm Inspiration finden, wie Doriana und Massimiliano Fuksas sowie Massimo Iosa Ghini.

La Fabbrica históricamente ha pensado siempre "lo bello" y diseña cerámicas para las marcas Ava y La Fabbrica, que se orientan en pos de los conceptos de belleza y elegancia, típicos del Made in Italy.

La fantasía de las gráficas y la atención prestada a cada detalle (materia, color, estructura, forma, embalaje, servicio, comunicación, técnica de comercialización) son acompañadas por una elevada atención a la calidad de realización de las baldosas y planchas de La Fabbrica y Ava.

La innovación del producto (bello, único, confiable, característico) es fruto de la estrecha sinergia entre las diferentes secciones de La Fabbrica tales como investigación y desarrollo (I&D), mercadotecnia, producción y calidad, que encuentran con frecuencia inspiración gracias a la colaboración con importantes arquitectos y diseñadores de fama mundial, tales como Doriana y Massimiliano Fuksas y Massimo Iosa Ghini.

В течение всей ее истории La Fabbrica постоянно работала над красотой. Она разрабатывает керамические изделия для брендов Ava и La Fabbrica, руководствуясь принципами красоты и элегантности, характерными для продукции "Made in Italy".

Креативность графического оформления и тщательная проработка каждой отдельной детали (материал, цвет, структура, форма, упаковка, поддержка, коммуникация, мерчандайзинг) сопровождаются пристальным вниманием, которое уделяется качеству производства плитки и плит брендов La Fabbrica и Ava.

Инновационные характеристики продукции (красота, уникальность, надежность, узнаваемость) являются результатом сплоченной работы разных подразделений La Fabbrica, например, отдел исследований и развития, отдел маркетинга, производственный отдел, отдел обеспечения качества, для которых часто источником вдохновения является сотрудничество со знаменитыми архитекторами и известными во всем мире дизайнерами, такими как Дориана и Массимилиано Фукас, Массимо Йоза Гини.



Evento Maxxi:
performance di Doriana e Massimiliano Fuksas su lastre Scratch di Ava.

Maxxi Event:
performance by Doriana and Massimiliano Fuksas on Ava Scratch slabs.

Événement Maxxi :
performance de Doriana et Massimiliano Fuksas sur les dalles Scratch d'Ava.

Veranstaltung Maxxi:
Performance von Doriana und Massimiliano Fuksas auf Platten Scratch von Ava.

Evento Maxxi:
performance de Doriana y Massimiliano Fuksas sobre planchas Scratch de Ava.

Мероприятие Maxxi:
перформанс Дорианы и Массимилиано Фукас на плитах Scratch от Ava.

ITALIAN DESIGN & MADE IN ITALY



Bologna Design Week 2019: Human Proportion project di Massimo Iosa Ghini, realizzato insieme a La Fabbrica con i rivestimenti interni ed esterni di Ava e La Fabbrica.

Bologna Design Week 2019: Human Proportion project by Massimo Iosa Ghini, created together with La Fabbrica with the internal and external tiles by Ava and La Fabbrica.

Bologna Design Week 2019 : Human Proportion project de Massimo Iosa Ghini, créé avec des revêtements pour l'intérieur et l'extérieur d'Ava et de La Fabbrica.

Bologna Design Week 2019: Das Human Proportion Project von Massimo Iosa Ghini, erstellt zusammen mit La Fabbrica und den Boden- und Wandbelägen für Innen- und Außenbereiche von Ava und La Fabbrica.

Semana del Diseño de Bolonia 2019: Proyecto de Proporciones Humanas de Massimo Iosa Ghini, realizado en conjunto con La Fabbrica, con revestimientos de interiores y exteriores de Ava y La Fabbrica.

Неделя дизайна 2019 в Болонье: проект "Human Proportion" от Массимо Йоза Гини, выполненный вместе с La Fabbrica с применением материалов брендов Ava и La Fabbrica для внутренней и наружной облицовки.

La gamma dei formati

Range of sizes
 La gamme des formats
 Die Palette der Formate
 La gama de los formatos
 Предлагаемый ассортимент форматов

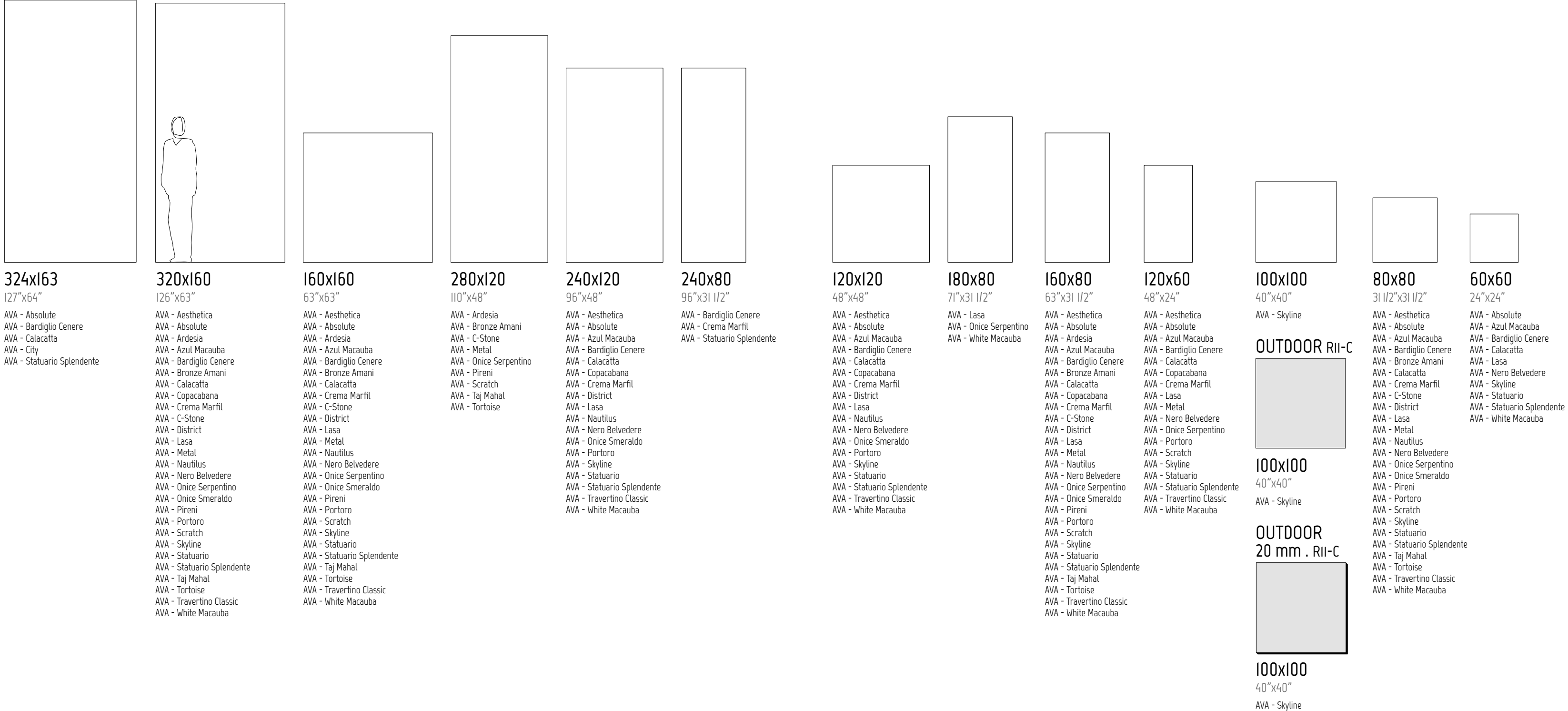

DALL'ARCHITETTURA AL DESIGN, UN MONDO DI APPLICAZIONI OLTRE L'ORDINARIO

From architecture to design, a world of applications beyond the ordinary.

De l'architecture au design, un monde d'application au-delà de l'ordinaire.

Von der Architektur bis zum Design, eine Welt von Anwendungen, die über das Übliche hinausgehen.

De la arquitectura al diseño, un mundo de aplicaciones fuera de lo común.

От архитектуры до дизайна: целый арсенал необычайных применений.

DUE SPESSORI PER PROGETTI SENZA COMPROMESSI10

Two different thicknesses for uncompromising designs.

Deux épaisseurs pour des projets sans compromis.

Zwei Stärken für Entwürfe ohne Kompromisse.

Dos espesores para proyectos sin compromisos.

Две толщины для бескомпромиссных проектов.

TOP E PIANI: IL DESIGN INTEGRATO12

Tops and floors: integrated design.

Dessus et plans : le design intégré.

Arbeitsplatte und einlegeböden. Das integrierte design.

Encimeras y planos: el diseño integrado.

Столешницы и полки: интегрированный дизайн.

INDOOR, OUTDOOR: NUOVI CONCETTI DI ARREDO E DI DESIGN14

INDOOR, OUTDOOR:
new concepts in furnishings and design.

INTÉRIEUR, EXTÉRIEUR :

de nouveaux concepts de décoration et de design.

INNENBEREICH, AUSSENBEREICH:

neue Konzepte der Einrichtung und des Designs.

INTERIORES, EXTERIORES:

nuevos conceptos para mobiliario y diseño.

ВНУТРИ И СНАРУЖИ:

новые концепции оформления и дизайна.

APRE A NUOVE INTERPRETAZIONI DI PROGETTO15

Opens doors to new design insights.

Permet de nouvelles interprétations de projet.

Öffnet sich neuen Interpretationen des Entwurfs.

Abre a nuevas interpretaciones de proyecto.

Открывает новые способы интерпретации проекта.

DAL DIRE AL FARE, DALL'IDEA AL PRODOTTO16

From words to actions, idea to product.

De la parole aux actes, de l'idée au produit.

Von Sagen zum Tun, von der Idee zum Produkt.

Del decir al hacer, de la idea al producto.

От слов - к делу, от идеи - к изделию.

18 I bordi

Edges.

Les bords.

Die Kanten.

Los bordes.

Кромки.

20 Come realizzare gli spigoli

How to make the edges.

Comment réaliser les arêtes.

Wie werden die Kanten ausgeführt.

Cómo realizar las aristas.

Изготовление углов.

22 Gli angoli a 45°

45° angles.

Les angles à 45°.

Die Ecken zu 45°.

Los ángulos en 45°.

Углы под 45°.

23 I fori per gli scassi

Holes for cutouts.

Les niches d'encastrement.

Die Bohrungen für die Aussparungen.

Los agujeros para las muescas.

Отверстия для вырезов.

24 Foratura circolare

Circular holes.

Perçage circulaire.

Runde Aussparung.

Perforación circular.

Изготовление круглых отверстий.

25 Foratura rettangolare

Rectangular holes.

Perçage rectangulaire.

Rechteckige Aussparung.

Perforación rectangular.

Изготовление прямоугольных отверстий.

FACCIAE VENTILATE E INCOLLATE28

Direct-bonded external wall tiles and curtain walls

Façades ventilées et collées

Hinterlüftete und verklebte Fassaden

Fachadas ventiladas y encoladas

Вентилируемые и наклеиваемые фасады

30 I Vantaggi delle facciate ventilate

The advantages of curtain walls.

Les avantages des façades ventilées.

Die Vorteile der hinterlüfteten Fassaden.

Las ventajas de las fachadas ventiladas.

Преимущества вентилируемых фасадов.

31 I vantaggi delle facciate incollate

The advantages of external wall tiles mounted with a direct bonding method.

Les avantages des façades collées.

Die Vorteile der verklebten Fassaden.

Las ventajas de las fachadas encoladas.

Преимущество наклеиваемых фасадов.

32 Sistemi di ancoraggio delle facciate ventilate

Anchorage systems for curtain walls.

Systèmes d'ancrage des façades ventilées.

Verankerungssysteme der hinterlüfteten Fassaden.

Sistemas de anclaje de las fachadas ventiladas.

Системы анкерровки вентилируемых фасадов.

34 Sistemi di ancoraggio della posa a colla in facciata

Anchorage systems for external wall tiles mounted with direct bonding method.

Systèmes d'ancrage de la pose à la colle sur les façades.

Verankerungssysteme der verklebten Fassaden.

Sistemas de anclaje para colocación con cola en fachada.

Система анкерровки уложенной на клей облицовки фасада.



EXTRA APPLICATION

Le superfici ceramiche EXTRAORDINARYSIZE si possono classificare a tutti gli effetti tra i materiali all'avanguardia per il design contemporaneo. Oltre ai pavimenti e ai rivestimenti, con le lastre EXTRAORDINARYSIZE è possibile realizzare piani e top per cucine, mobili da bagno, arredi per il soggiorno coordinati, di qualsiasi forma e dimensione.

EXTRAORDINARYSIZE ceramic tiles are quite simply cutting-edge materials for contemporary design. In addition to floors and walls, EXTRAORDINARYSIZE tiles can be used to create kitchen tops and coordinated furniture - of any shape and size - for living rooms and bathrooms.

Les surfaces en céramique EXTRAORDINARYSIZE peuvent être classées à part entière parmi les matériaux d'avant-garde pour le design contemporain. Outre les carrelages et les revêtements, les dalles EXTRAORDINARYSIZE permettent de réaliser des plateaux et des plans de travail pour les cuisines, les meubles de salle de bains, les meubles coordonnés pour les salles de séjour, de toutes formes et dimensions.

Die keramischen Oberflächen EXTRAORDINARYSIZE können in jeder Hinsicht zu den fortschrittlichen Materialien für das moderne Design gezählt werden. Neben den Boden- und Wandbelägen lassen sich mit den Platten EXTRAORDINARYSIZE Flächen und Arbeitsplatten für Küchen, Badmöbel sowie farblich passende Einrichtungselemente für den Wohnraum in jeglicher Form und Größe herstellen.

Las superficies cerámicas EXTRAORDINARYSIZE pueden ser clasificadas para todos los efectos entre los materiales de vanguardia para el diseño contemporáneo. Además de pavimentos y revestimientos, con las losas EXTRAORDINARYSIZE es posible realizar planos y encimeras para cocinas, mobiliario para el baño y muebles para sala de estar coordinados, en todas las formas y dimensiones.

Керамические поверхности EXTRAORDINARYSIZE можно полноправно назвать передовыми материалами для современного дизайна. Помимо полов и облицовки, при помощи плит EXTRAORDINARYSIZE можно создавать полки и кухонные столешницы, мебель для ванной, сочетающуюся мебель для гостиной, любой формы и размеров.

Due spessori per progetti senza compromessi

Two different thicknesses for uncompromising designs.
Deux épaisseurs pour des projets sans compromis.
Zwei Stärken für Entwürfe ohne Kompromisse.
Dos espesores para proyectos sin compromisos.
Две толщины для бескомпромиссных проектов.

EXTRAORDINARYSIZE comprende due spessori che risolvono vincoli tecnici specifici nei diversi contesti di un progetto.

Ciò consente al designer la massima libertà espressiva mantenendo coerenza di stile tra pavimenti, rivestimenti e complementi di arredo presenti nell'ambiente, garantendo il massimo risultato sia estetico che pratico.

EXTRAORDINARYSIZE comprend deux épaisseurs qui résolvent les contraintes techniques spécifiques dans les différents contextes d'un projet.

Le designer jouit donc de la plus grande liberté d'expression sans bouleverser la cohérence stylistique entre les carrelages, les revêtements et les éléments de décoration présents dans la pièce, et avec la garantie du meilleur résultat esthétique et pratique.

EXTRAORDINARYSIZE includes two thicknesses that address specific technical constraints in different design contexts.

This gives designers total freedom of expression, while maintaining the same style throughout the floors, walls, and even the furnishing accessories featured in the interior, guaranteeing a stunning and practical finished project.

EXTRAORDINARYSIZE umfasst zwei Stärken, die spezifische technische Auflagen in den verschiedenen Kontexten eines Entwurfs lösen.

Dies bietet dem Designer die maximale Ausdrucksfreiheit bei Kohärenz des Stils zwischen Bodenbelägen, Wandbelägen und im Raum vorhandenem Einrichtungszubehör, wobei das maximale Ergebnis sowohl in ästhetischer als auch in praktischer Hinsicht garantiert wird.

EXTRAORDINARYSIZE comprende dos espesores que satisfacen requerimientos técnicos específicos en los variados contextos de un proyecto.

Ello permite al diseñador máxima libertad expresiva, manteniendo coherencia de estilo entre pavimentos, revestimientos y complementos de mobiliario presentes en el ambiente, garantizando así la obtención del máximo a nivel estético y práctico.

EXTRAORDINARYSIZE включает в себя две толщины, которые удовлетворяют специальные технические требования в различных аспектах проекта.

Это наделяет дизайнера наивысшей свободой выражения при сохранении сочетаемости стиля полов, облицовки и дополнений интерьера, гарантируя достижение наивысшего результата, как в плане эстетики, так и практичности.

6 mm (1/4")

320x160 cm
(126"x63")



Oltre le tipiche funzionalità tecniche del gres porcellanato lo spessore 6 mm si caratterizza per essere una superficie leggera estremamente pratica nell'ambito del design, dell'arredo e delle pareti ventilate o incollate.

L'épaisseur 6 mm présente les fonctionnalités typiques du grès cérame et elle est caractérisée par une surface légère extrêmement pratique dans le domaine du design, de la décoration et des parois ventilées ou collées.

Besides the standard technical features of porcelain stoneware, the 6 mm thick version offers a lightweight option which is extremely practical in the field of interior design and furniture, as well as for curtain walls or wall tiles mounted with a direct bonding method.

Neben den typischen technischen Eigenschaften des Feinsteinzeugs ist die Stärke von 6 mm dadurch gekennzeichnet, dass es sich um eine leichte und im Bereich des Design, der Einrichtung und der hinterlüfteten bzw. verklebten Fassaden äußerst praktische Oberfläche handelt.

Además de las características técnicas propias del gres porcelánico, el espesor de 6 mm se caracteriza por ser una superficie ligera extremadamente práctica para los efectos del diseño, del mobiliario y de las paredes ventiladas o encoladas.

Помимо типовых технических характеристик керамогранита, толщина 6 мм позволяет получать легкие поверхности, очень практичные в сфере дизайна, оформления интерьеров, в облицовке стен и для изготовления вентилируемых фасадов.

12 mm (1/2")

324x163 cm
(127"x64")

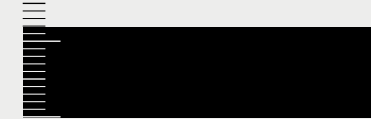

Lo spessore 12 mm si differenzia per una superiore resistenza meccanica. Da preferire per realizzare top cucina, tavoli, sedute.

L'épaisseur 12 mm se distingue par une résistance mécanique supérieure. Privilégier cette épaisseur pour la réalisation des plans de travail des cuisines, des tables, des sièges.

The 12 mm thick version offers higher mechanical strength. This thicker option is recommended for the production of kitchen tops, tables, and chairs.

Die Stärke von 12 mm unterscheidet sich durch eine höhere mechanische Festigkeit. Diese ist bei der Herstellung von Arbeitsplatten für die Küche, Tischen und Sitzgelegenheiten vorzuziehen.

El espesor 12 mm se diferencia por una superior resistencia mecánica. Es apropiado para realizar encimeras de cocina, mesas y asientos.

Толщина 12 мм отличается более высокой механической прочностью. Ей отдается предпочтение при изготовлении кухонных столешниц, столов и сидений.

Top e piani: il design integrato

Tops and floors: integrated design.
Dessus et plans : le design intégré.
Arbeitsplatte und einlegeböden. Das integrierte design.
Encimeras y planos: el diseño integrado.
Столешницы и полки: интегрированный дизайн.

Spaziando dallo spessore 6 al 12 mm delle lastre EXTRAORDINARYSIZE, è possibile realizzare piani e top di qualsiasi forma e dimensione progettati sulla superficie continua di 320x160 cm per il 6 mm e 324x163 cm per il 12 mm.

Superfici straordinarie che garantiscono il massimo valore estetico congiuntamente a tutti i vantaggi tecnologici del gres porcellanato e che consentono di coordinare le superfici dei pavimenti e rivestimenti con gli elementi di arredo presenti in tutti gli spazi circostanti.

Les épaisseurs 6 et 12 mm des dalles EXTRAORDINARYSIZE permettent de réaliser des plateaux et des plans de travail de toutes formes et dimensions conçus pour une surface continue de 320x160 pour l'épaisseur 6 mm et le format 324x163 cm pour l'épaisseur 12 mm.

Des surfaces extraordinaires qui garantissent la plus grande valeur esthétique avec tous les avantages technologiques du grès cérame et qui permettent de coordonner les surfaces des carrelages des revêtements avec les éléments de décoration présents dans tous les espaces environnants.

Con los espesores de 6 y 12 mm de las losas EXTRAORDINARYSIZE es posible realizar encimeras y planos de cualquier forma e dimensiones, diseñados sobre la superficie continua de 320 x 160 en el espesor 6 mm y 324x163 cm para el espesor 12 mm.

Superficies extraordinarias que garantizan máximo valor estético además de todas las ventajas tecnológicas del gres porcelánico y permiten coordinar las superficies de los pavimentos y revestimientos con todos los componentes de mobiliario presentes en los espacios circunstantes.

Featuring 6 mm and 12 mm thick versions, EXTRAORDINARYSIZE tiles can be used to create kitchen tops of any shape and size, using a base slab measuring 320x160 cm for the 6 mm version and 324x163 cm for the 12 mm version.

This out-of-the-ordinary material guarantees stunning designs offering all the technological advantages of porcelain stoneware and allows floors and walls to be coordinated with the furniture featured in all the surrounding spaces.

Mit einer Stärke im Bereich von 6 bis 12 mm können die Platten EXTRAORDINARYSIZE zur Herstellung von Arbeitsplatten für Küchen und Flächen in beliebiger Form und Größe verwendet werden, die auf einer durchgehenden Oberfläche von 320x160 cm bei der Stärke von 6 mm und von 324x163 cm bei der Stärke von 12 mm entworfen werden.

Es handelt sich um außerordentliche Oberflächen, die den maximalen ästhetischen Wert zusammen mit allen technologischen Vorteilen des Feinsteinzeugs garantieren und es ermöglichen, die Oberflächen von Boden- und Wandbelägen mit den in allen umliegenden Räumlichkeiten vorhandenen Einrichtungs-elementen farblich abzustimmen.

При толщине плит EXTRAORDINARYSIZE от 6 до 12 мм можно изготавливать полки и столешницы любой формы и размеров, отталкиваясь от сплошной поверхности в формате 320x160 см толщиной 6 мм и 324x163 см толщиной 12 мм.

Эти удивительные материалы создают наивысшую эстетическую ценность наряду со всеми технологическими преимуществами керамогранита, а также позволяют сочетать поверхности полов и облицовки с элементами оформления интерьера, находящимися во всех окружающих пространствах.



A

B

C

A	B	C
TAVOLO: Table Table Tisch Mesa Стол	RIVESTIMENTO: Wall tiling Revêtement Verblendung Revestimiento Облицовка	MENSOLA: Shelf Étagère Konsole Repisa Полка
Contemporanei Skyline Chiaccio Nat. Ret. 6 mm	Contemporanei Skyline Chiaccio Nat. Ret. 6 mm	Contemporanei Skyline Chiaccio Nat. Ret. 6 mm

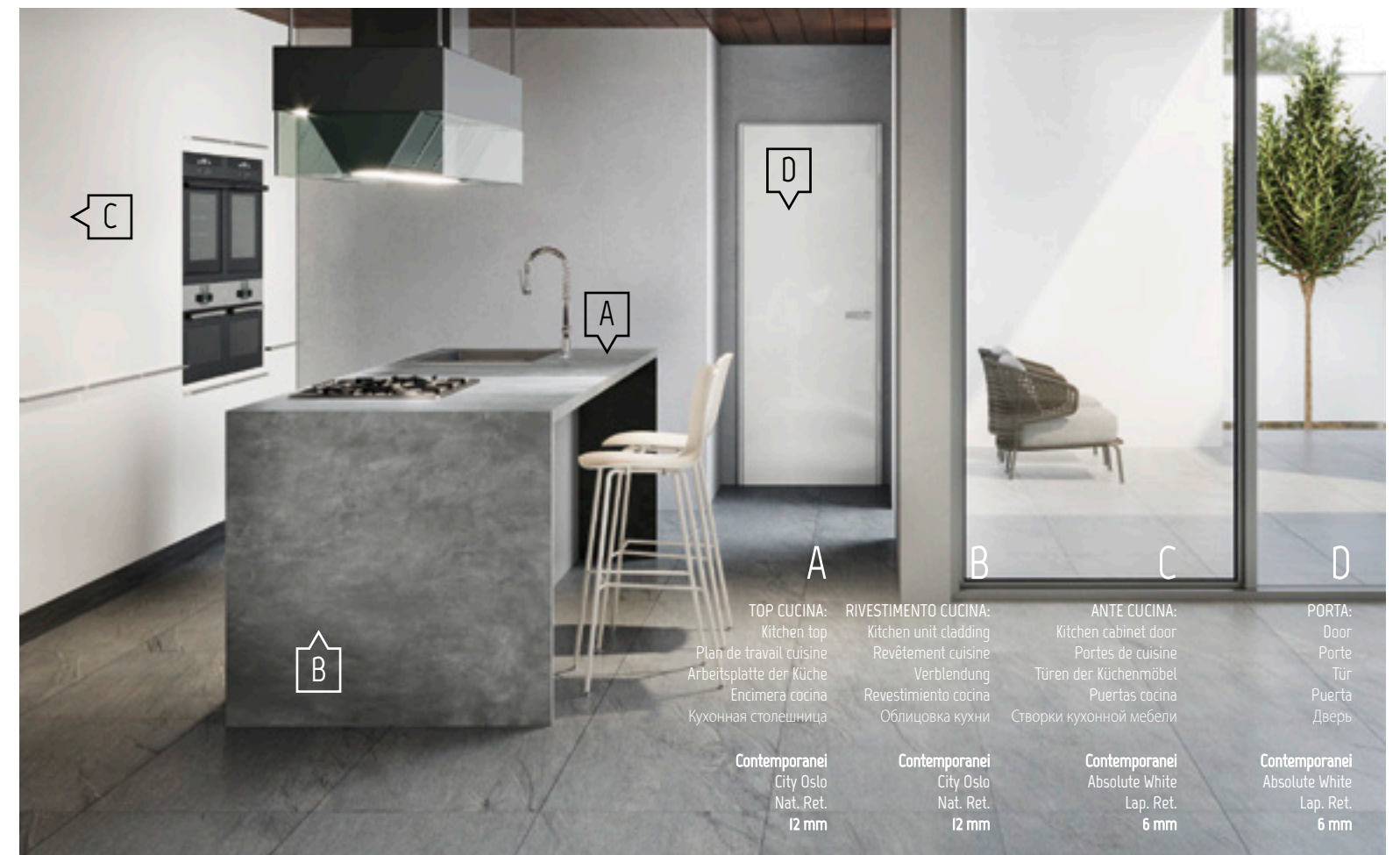

A

D

B

C

D

TOP CUCINA: Kitchen top Plan de travail cuisine Arbeitsplatte der Küche Encimera cocina Кухонная столешница	RIVESTIMENTO CUCINA: Kitchen unit cladding Revêtement cuisine Verblendung Revestimiento cocina Облицовка кухни	ANTE CUCINA: Kitchen cabinet door Portes de cuisine Türen der Küchenmöbel Puertas cocina Створки кухонной мебели	PORTA: Door Porte Tür Puerta Дверь
Contemporanei City Oslo Nat. Ret. 12 mm	Contemporanei City Oslo Nat. Ret. 12 mm	Contemporanei Absolute White Lap. Ret. 6 mm	Contemporanei Absolute White Lap. Ret. 6 mm

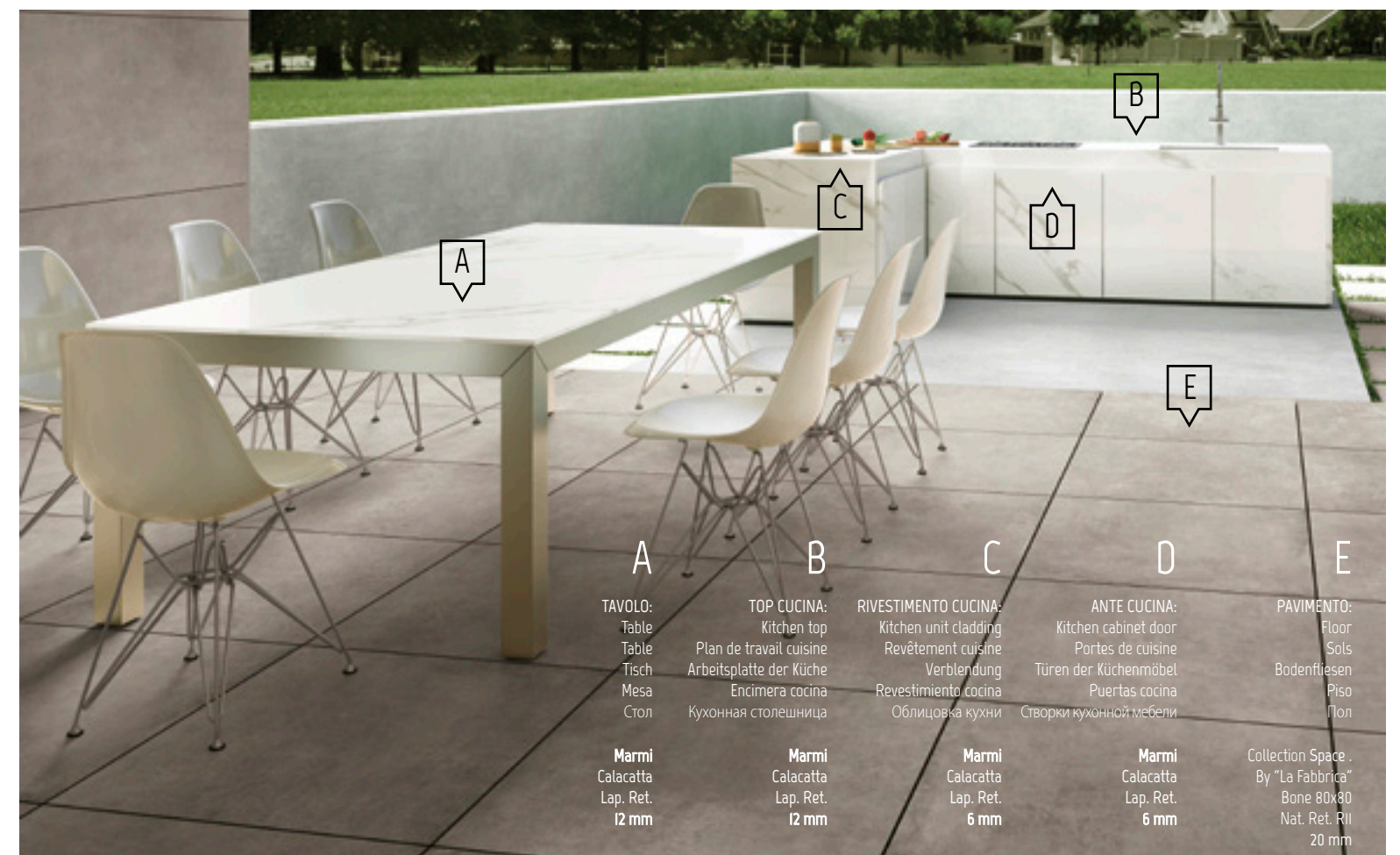

A

B

C

D

E

A	B	C	D	E
TAVOLO: Table Table Tisch Mesa Стол	TOP CUCINA: Kitchen top Plan de travail cuisine Arbeitsplatte der Küche Encimera cocina Кухонная столешница	RIVESTIMENTO CUCINA: Kitchen unit cladding Revêtement cuisine Verblendung Revestimiento cocina Облицовка кухни	ANTE CUCINA: Kitchen cabinet door Portes de cuisine Türen der Küchenmöbel Puertas cocina Створки кухонной мебели	PAVIMENTO: Floor Sols Bodenfliesen Piso Пол
Marmi Calacatta Lap. Ret. 12 mm	Marmi Calacatta Lap. Ret. 12 mm	Marmi Calacatta Lap. Ret. 6 mm	Marmi Calacatta Lap. Ret. 6 mm	Collection Space . By "La Fabbrica" Bone 80x80 Nat. Ret. R11 20 mm

INDOOR, OUTDOOR: nuovi concetti di arredo e di design

INDOOR, OUTDOOR: new concepts in furnishings and design.

INTÉRIEUR, EXTÉRIEUR : de nouveaux concepts de décoration et de design.

INNENBEREICH, AUSSENBEREICH: neue Konzepte der Einrichtung und des Designs.

INTERIORES, EXTERIORES: nuevos conceptos para mobiliario y diseño.

ВНУТРИ И СНАРУЖИ: новые концепции оформления и дизайна.

La possibilità di ricavare dalla grande unità di superficie della lastra forme personalizzate, l'ampia scelta di grafiche, le finiture naturali e lappata e gli spessori differenziati rendono il progetto EXTRAORDINARYSIZE un vero programma di materiali per l'arredo contemporaneo.

Sia in ambienti indoor che outdoor è ideale per rivestire ogni tipo di struttura e ottenere composizioni ricercate corredate da complementi di design, semplici da lavorare e pratici da realizzare.

Grâce à la possibilité d'obtenir des formes personnalisées à partir de la grande unité de surface de la dalle, au vaste choix de graphismes, aux finitions naturelle et rodée et aux épaisseurs différenciées, le projet EXTRAORDINARYSIZE devient un véritable programme de matériaux pour la décoration contemporaine.

À l'intérieur et à l'extérieur, il est parfait pour revêtir tout type de structure et obtenir des compositions raffinées avec des compléments de design simples à travailler et pratiques à réaliser.

The possibility of crafting bespoke items from a large slab, the vast assortment of graphics, the natural and lapped finishes, and the various thickness options make EXTRAORDINARYSIZE the go-to collection for contemporary design.

Both indoors and out, it is ideal for cladding all kinds of constructions, producing stylish arrangements accented by design-led accessories, with materials that are easy to work with and practical to use.

Die Möglichkeit, aus der großen Oberflächeneinheit der Platte Formen nach Wunsch des Kunden zu gewinnen, die breite Auswahl der Grafiken, die natürliche und die geläppte Oberfläche sowie die unterschiedlichen Stärken machen das Projekt EXTRAORDINARYSIZE zu einem wahren Programm von Materialien für die moderne Einrichtung.

Sowohl in Innen- als auch in Außenbereichen ist es ideal zur Verkleidung von jeder Art von Struktur und zur Zielung von farblich abgestimmten Kombinationen aus Design-Elementen, die sich einfach bearbeiten und praktisch herstellen lassen.



La posibilidad de obtener formas personalizadas gracias a la gran unidad de superficie de la losa, la amplia elección de gráficas, los acabados natural y lapeado y los espesores diferenciados, hacen del proyecto EXTRAORDINARYSIZE un auténtico programa de materiales para la ornamentación contemporánea.

Tanto en interiores como exteriores es ideal para revestir todo tipo de estructuras y obtener refinadas composiciones, acompañadas por complementos de diseño, sencillos en su elaboración y prácticos en su realización.

Возможность получить из плиты большой площади индивидуальные формы, широкий выбор графики, натуральная и притертая отделки поверхности, а также дифференцированная толщина, превращают проект EXTRAORDINARYSIZE в настоящую программу материалов для современных необходимых оформлений.

Как в помещениях, так и снаружи, он отлично подходит для облицовки конструкций любого типа и для создания изысканных композиций, которые дополняют элементы дизайна, простые в обработке и практичные в изготовлении.



Aprire a nuove interpretazioni di progetto

Opens doors to new design insights.

Permet de nouvelles interprétations de projet.

Öffnet sich neuen Interpretationen des Entwurfs.

Abre a nuevas interpretaciones de proyecto.

Открывает новые способы интерпретации проекта.



A

PORTA:
Door
Porte
Tür
Puerta
Дверь

Marmi
Calacatta
Lap. Ret.
6 mm

B

RIVESTIMENTO PARETE:
Wall tiling
Revêtement mural
Wandbelag
Revestimiento pared
Облицовка стены

Marmi
Calacatta
320x160 Lap. Ret.
6 mm

C

PAVIMENTO:
Floor
Sols
Bodenfliesen
Piso
Пол

Marmi
Calacatta
320x160 Lap. Ret.
6 mm

Grazie allo spessore sottile, alla versatilità e alla robustezza del gres porcellanato, le lastre EXTRAORDINARYSIZE si prestano a rivestire porte e ante di ambienti pubblici e residenziali, garantendo continuità estetica con le superfici circostanti.

Thanks to its slender form and the versatility and strength of porcelain stoneware, EXTRAORDINARYSIZE slabs are ideal for use as trim panels for doors of all shapes and sizes in public areas and homes alike, providing seamless continuity with the surrounding surfaces.

Grâce à l'épaisseur fine, à la polyvalence et à la solidité du grès cérame, les dalles EXTRAORDINARYSIZE sont parfaites pour revêtir les portes et les vantaux des espaces publics et résidentiels, tout en garantissant la continuité esthétique avec les surfaces environnantes.

Durch die geringe Stärke, die Vielseitigkeit und die Robustheit des Feinsteinzeugs eignen sich die Platten EXTRAORDINARYSIZE zur Verblendung von Türen und Schranktüren in öffentlichen Bereichen und Wohnungen, wobei ästhetische Abstimmung auf die umliegenden Oberflächen garantiert wird.

Gracias a su reducido espesor, a la versatilidad y a la solidez del gres porcelánico, las losas EXTRAORDINARYSIZE se prestan para revestir puertas y hojas de ambientes públicos y residenciales, garantizando continuidad estética con las superficies circundantes.

Благодаря небольшой толщине, универсальности и прочности керамогранита плиты EXTRAORDINARYSIZE могут использоваться для облицовки дверей и створок мебели в общественных и жилых интерьерах, гарантируя эстетическое сочетание с окружающими поверхностями.

Dal dire al fare, dall'idea al prodotto

From words to actions, idea to product.
 De la parole aux actes, de l'idée au produit.
 Von Sagen zum Tun, von der Idee zum Produkt.
 Del decir al hacer, de la idea al producto.
 От слов - к делу, от идеи - к изделию.

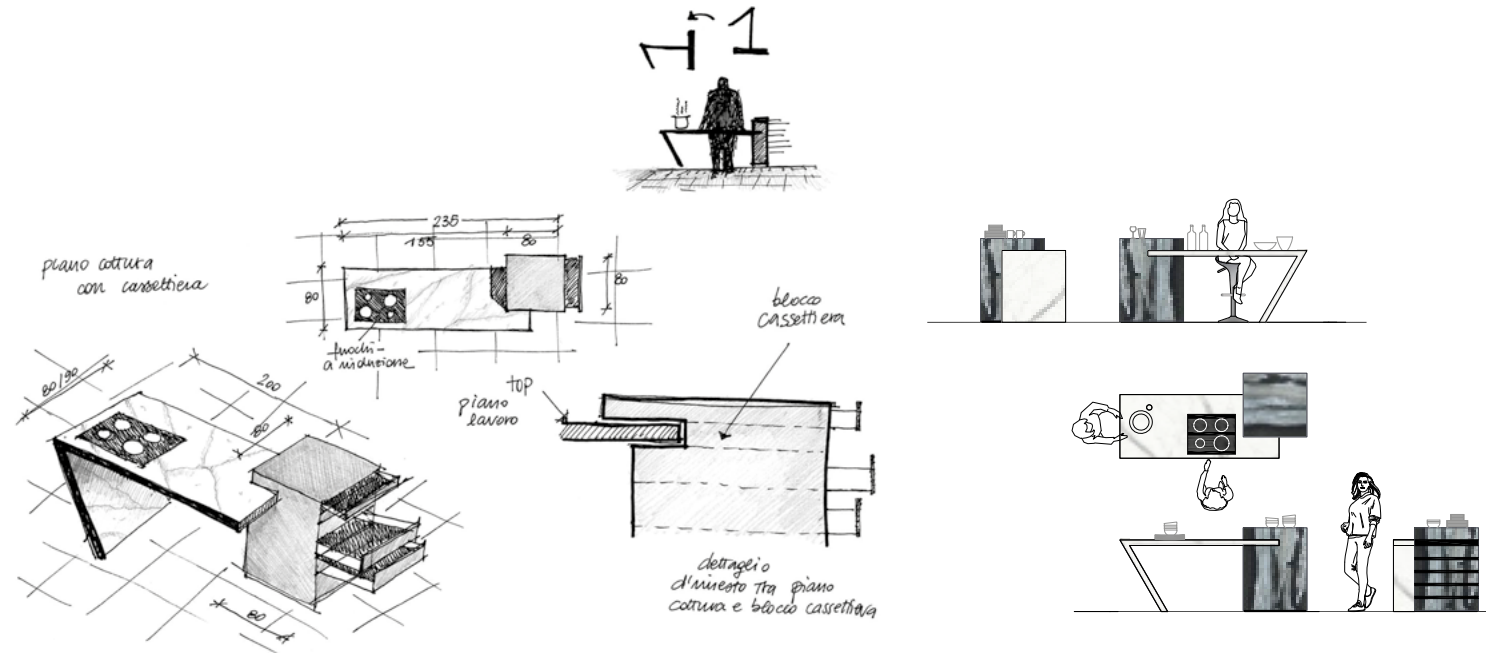

Forme, dimensioni, applicazioni: con EXTRAORDINARYSIZE ogni lavorazione è realizzata su misura per dare vita alla fantasia e alle richieste di ogni cliente, protagonista assoluto della propria creatività.

Shapes, sizes, applications ... with EXTRAORDINARYSIZE all the materials are custom-processed to give form to the imagination and meet the needs of every single customer, making you the master of your own creativity.

Formes, dimensions, applications : avec EXTRAORDINARYSIZE chaque ouvrage est réalisé sur mesure pour donner ouverte cours à l'imagination et aux exigences de chaque client, qui est le protagoniste absolu de sa créativité.

Formen, Abmessungen, Anwendungen: mit EXTRAORDINARYSIZE wird jede Bearbeitung nach Maß ausgeführt, um die Fantasie und den Wünschen jedes Kunden Leben zu verleihen, der der unbedingte Protagonist der eigenen Kreativität ist.

Formas, dimensiones, aplicaciones: con EXTRAORDINARYSIZE cada trabajo es realizado a medida para dar vida a la fantasía y a los requerimientos de cada cliente, protagonista absoluto de su propia creatividad.

Формы, размеры, применения: благодаря EXTRAORDINARYSIZE любая обработка выполняется строго в размер, чтобы воплотить в жизнь фантазию и требования каждого клиента, являющегося основной фигурой своей креативности.

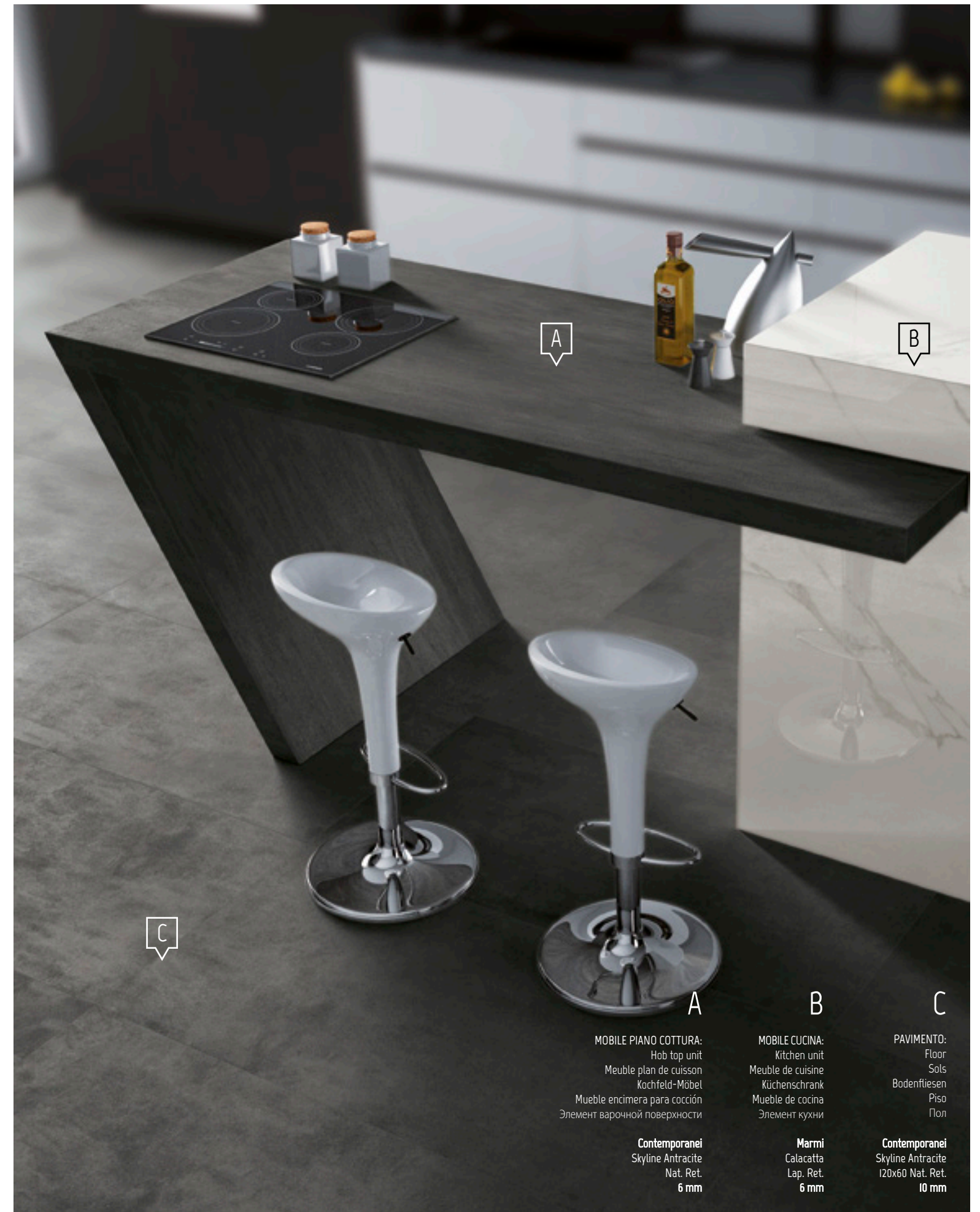

A

B

C

MOBILE PIANO COTTURA:
 Hob top unit
 Meuble plan de cuisson
 Kochfeld-Möbel
 Mueble encimera para cocción
 Элемент варочной поверхности

MOBILE CUCINA:
 Kitchen unit
 Meuble de cuisine
 Küchenschrank
 Mueble de cocina
 Элемент кухни

PAVIMENTO:
 Floor
 Sols
 Bodenfliesen
 Piso
 Пол

Contemporanei
 Skyline Antracite
 Nat. Ret.
 6 mm

Marmi
 Calacatta
 Lap. Ret.
 6 mm

Contemporanei
 Skyline Antracite
 120x60 Nat. Ret.
 10 mm

I bordi

Edges.
Les bords.
Die Kanten.
Los bordes.
Кромки.

Esempi di bordi su lastre da 6 o 12 mm.

Examples of 6 or 12 mm slab edges.
Exemples de bord sur des dalles de 6 ou 12 mm.
Beispiele für Kanten bei Platten zu 6 oder 12 mm.
Ejemplos de bordes sobre losas de 6 o 12 mm.
Примеры кромок на плитках толщиной 6 или 12 мм.

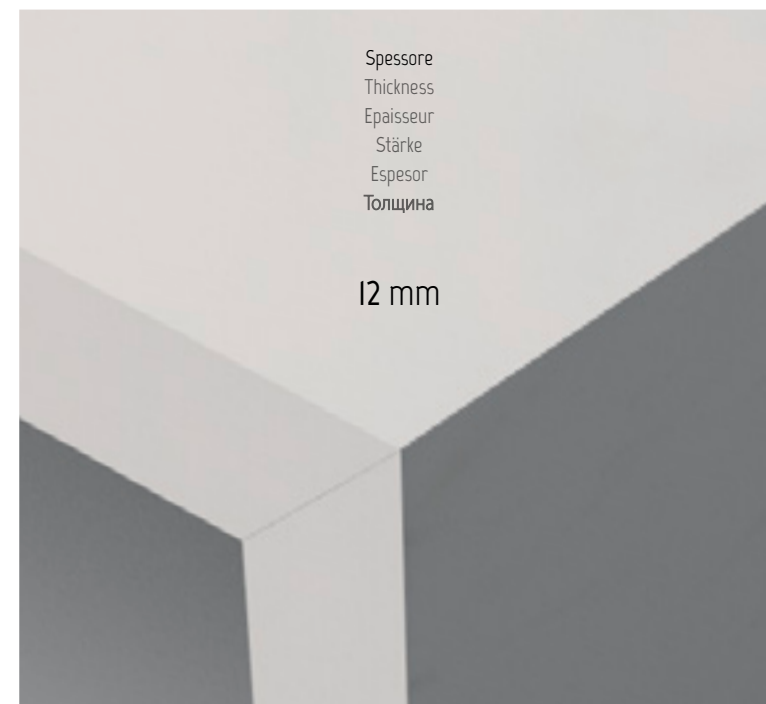
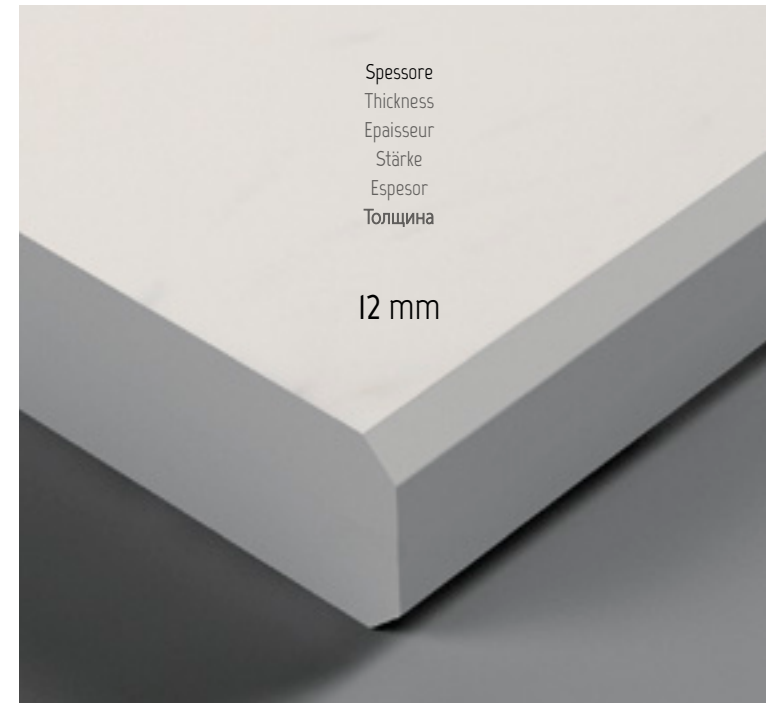

Qualsiasi tipo di bordo si andrà a realizzare dovrà essere completato con un rompifilo o bisello perimetrale e la sua finitura potrà essere realizzata su macchine automatiche o manualmente con i dischi idonei.

Il bordo diritto deve avere una larghezza di almeno 2 mm, quello arrotondato un angolo di curvatura di almeno R 2 mm ed un terzo bordo può essere realizzato con lastre 12 mm, con angolo inferiore a 30-35° con finitura superiore come indicato.

Whatever kind of edge you intend to use will have to be completed with a chamfer or bevel around the perimeter and its finish can be produced using either automatic machines or manually, using suitable discs.

A straight edge must be at least 2 mm wide, while rounded edges must have a curvature angle of at least R 2 mm, and a third edge can be made with 12 mm thick slabs with an angle of less than 30-35° and an upper finish as specified.

Tous les bords devront être réalisés avec un casse-fil ou un biseau sur le périmètre et leur finition pourra être réalisée sur des machines automatiques ou manuellement avec des disques appropriés.

Le bord droit doit avoir une largeur d'au moins 2 mm, le bord arrondi doit présenter un angle de courbure d'au moins R 2 mm et un troisième bord peut être réalisé au moyen de dalles de 12 mm avec un angle inférieur à 30-35° et une finition supérieure d'après les indications.

Jegliche hergestellte Art von Kante muss mit einem Kantenbrecher oder einer umlaufenden Abschrägung fertiggestellt werden und ihre Feinbearbeitung kann auf automatischen Maschinen bzw. manuell mit geeigneten Scheiben erfolgen.

Die gerade Kante muss eine Breite von mindestens 2 mm haben, die abgerundete einen Radius von R 2 mm und eine dritte Kante kann bei Platten zu 12 mm, mit einer unteren Kante zu 30-35° mit einer oberen Ausführung gemäß Angabe versehen werden.

Cualquiera que sea el tipo de borde que se ejecutará, deberá ser completado ejecutando un bisel perimetral, cuyo acabado podrá ser realizado en máquinas automáticas, o bien, manualmente con discos apropiados.

El borde recto debe tener una anchura mínima de 2 mm, aquel redondeado un ángulo de curvatura mínimo de R 2 mm y un tercer borde puede ser realizado en losas de 12 mm, con ángulo inferior de 30-35° y con acabado superior tal como ya se ha indicado.

Любой тип выполняемой кромки должен завершаться фаской или закруглением по всему периметру, а их отделка может выполняться на автоматическом оборудовании пригодными для этих целей дисками или же вручную.

Прямая кромка должна иметь ширину не менее 2 мм, закругленная - радиус не менее 2 мм, третья же кромка может быть выполнена на плитках 12 мм с углом менее 30-35° и отделкой поверхности, как указано выше.

Lastra 6 mm
6 mm slab . Dalle 6 mm . Platte zu 6 mm
Losa 6 mm . 6-мм плита



Lastra 12 mm
12 mm slab . Dalle 12 mm . Platte zu 12 mm
Losa 12 mm . 12-мм плита

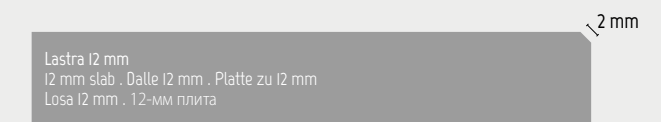

Lastra 6 mm
6 mm slab . Dalle 6 mm . Platte zu 6 mm
Losa 6 mm . 6-мм плита

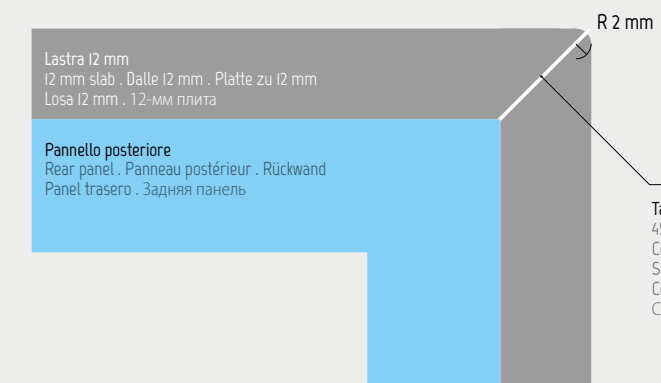
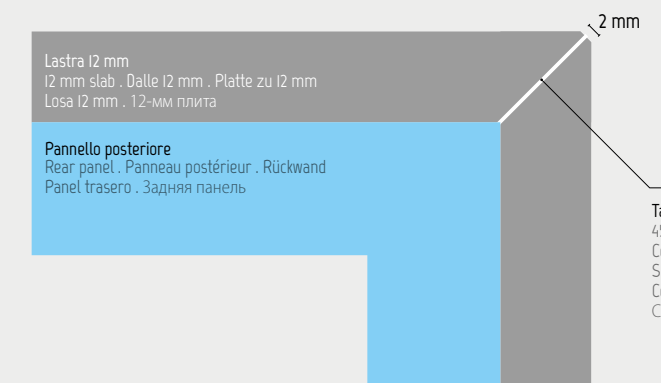
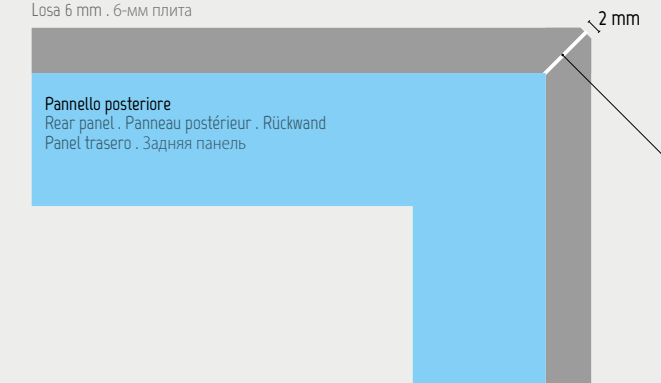

Come realizzare gli spigoli

How to make the edges.
Comment réaliser les arêtes.
Wie werden die Kanten ausgeführt.
Cómo realizar las aristas.
Изготовление углов.

1. Stendere l'adesivo sul supporto.
2. Posare la prima lastra, poi accostare la seconda utilizzando crocette da 1 mm.
3. Con una spatola, stendere stucco epossidico nella fuga.
4. Rimuovere gli eccessi di stucco con una spugna bagnata con acqua calda e alcool.
5. Quando l'adesivo avrà maturato la presa, eseguire con una smerigliatrice manuale la finitura dello spigolo eliminando la parte viva.
6. Con un tampone o un pads diamantato rifinire i bordi taglienti della lastra.

1. Spread the adhesive over the substrate.
2. Lay the first slab, then position the second slab close to it, using 1 mm spacers.
3. Using a trowel, spread epoxy grout into the joint.
4. Remove the excess grout with a wet sponge, hot water, and alcohol.
5. Once the adhesive has set, finish the edge with a manual grinder, removing the raw part.
6. With a rubber pad or a diamond pad, hone the slab's sharp edges.

1. Étaler la colle sur le support.
2. Poser la première dalle, puis la deuxième dalle en utilisant des croisillons de 1 mm.
3. Avec une spatule, étaler le mastic époxy dans le joint.
4. Éliminer le mastic en excès avec une éponge imbibée d'eau chaude et d'alcool.
5. Lorsque la colle aura durci, réaliser la finition manuelle de l'arête avec une ponceuse, en éliminant la partie vive.
6. Finir les bords tranchants de la dalle avec un tampon ou un pads diamanté.

1. Tragen Sie den Klebstoff auf den Untergrund auf.
2. Verlegen Sie die erste Platte. Legen Sie dann die zweite Platte unter Verwendung von Fliesenkreuzen von 1 mm an.
3. Füllen Sie mit einem Spachtel Epoxid-Spachtelmasse in die Fuge.
4. Entfernen Sie die überschüssige Spachtelmasse mit einem in warmem Wasser und Alkohol angefeuchteten Schwamm.
5. Führen Sie, wenn der Klebstoff ausgehärtet ist, mit einer Schmirgelmaschine die Feinbearbeitung der Kante durch Entfernen des scharfen Teils aus.
6. Nehmen Sie mit einem Pad oder einer Diamantscheibe die Feinbearbeitung der scharfen Kanten der Platte vor.

1. Extender el adhesivo sobre el soporte.
2. Colocar la primera losa; a continuación colocar la segunda, utilizando crucetas de 1 mm.
3. Con una espátula extender estuco epoxi en la junta.
4. Eliminar los excesos de estuco usando una esponja mojada con agua caliente y alcohol.
5. Una vez que el adhesivo se ha fijado, ejecutar con una amoladora manual el acabado de la arista, eliminando la parte excedente.
6. Con un tampón o una almohadilla diamantada eliminar los bordes cortantes de la losa.

1. Нанесите клей на основу.
2. Уложите первую плитку, затем приложите вторую, используя крестики 1 мм.
3. Затрите шов эпоксидной затиркой, используя для этого шпатель.
4. Удалите излишки затирки губкой, смоченной теплой водой со спиртом.
5. Когда клей схватится, ручной шлифмашинкой выполните отделку кромки, удалив острый угол.
6. При помощи притирки или алмазной губки отделайте острые кромки плитки.

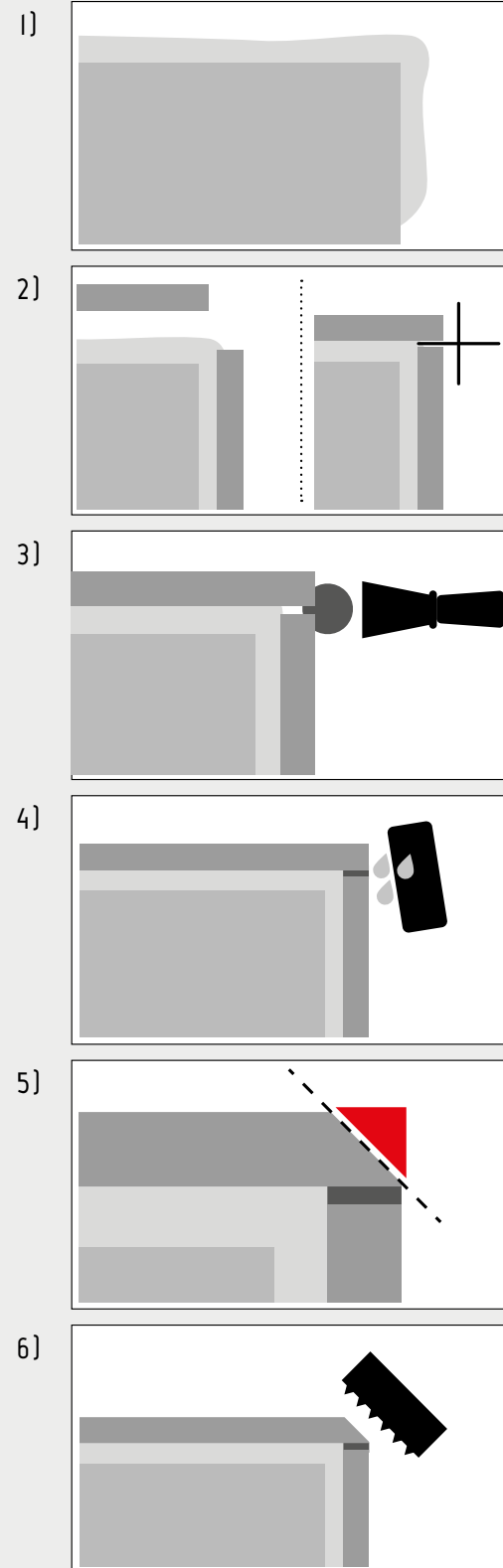

Questa soluzione prevede la jollatura delle lastre a 45°. Per realizzare una finitura a spigolo dall'aspetto estetico convincente senza l'utilizzo di profili eseguire i seguenti passaggi.

1. Stendere l'adesivo sul supporto.
2. Posare la prima lastra, poi accostare la seconda utilizzando crocette da 1 mm.
3. Quando l'adesivo avrà maturato la presa, eseguire con una smerigliatrice manuale la finitura dello spigolo eliminando la parte viva.
4. Con un tampone o un pads diamantato, rifinire i bordi taglienti della lastra.
5. Con una spatola, stendere stucco epossidico nella fuga.
6. Rimuovere gli eccessi di stucco con una spugna bagnata con acqua calda e alcool.

This solution involves cutting the slabs at 45°.

To achieve an edge with a flawless finish without using section bars, perform the following steps.

1. Spread the adhesive over the substrate.
2. Lay the first slab, then position the second slab close to it, using 1 mm spacers.
3. Once the adhesive has set, finish the edge with a manual grinder, removing the raw part.
4. With a rubber pad or a diamond pad, hone the slab's sharp edges.
5. Using a trowel, spread epoxy grout into the joint.
6. Remove the excess grout with a wet sponge, hot water, and alcohol.

Cette solution prévoit le biseautage des dalles à 45°.

Pour réaliser une finition en arête esthétique et convaincante sans utiliser de profils, procéder comme suit.

1. Étaler la colle sur le support.
2. Poser la première dalle, puis la deuxième dalle en utilisant des croisillons de 1 mm.
3. Lorsque la colle aura durci, réaliser la finition manuelle de l'arête avec une ponceuse, en éliminant la partie vive.
4. Finir les bords tranchants de la dalle avec un tampon ou un pads diamanté.
5. Avec une spatule, étaler le mastic époxy dans le joint.
6. Éliminer le mastic en excès avec une éponge imbibée d'eau chaude et d'alcool.

Diese Lösung sieht die Verwendung der Fliese zur Erstellung von Universalformstücken von 45° vor. Zur Herstellung einer Ausführung mit Kante mit ästhetisch überzeugendem Aussehen ohne Verwendung von Profilen, sind die folgenden Schritte auszuführen.

1. Tragen Sie den Klebstoff auf den Untergrund auf.
2. Verlegen Sie die erste Platte. Legen Sie dann die zweite Platte unter Verwendung von Fliesenkreuzen von 1 mm an.
3. Führen Sie, wenn der Klebstoff ausgehärtet ist, mit einer Schmirgelmaschine die Feinbearbeitung der Kante durch Entfernen des scharfen Teils aus.
4. Nehmen Sie mit einem Puffer oder einer Diamantscheibe die Feinbearbeitung der scharfen Kanten der Platte vor.
5. Füllen Sie mit einem Spachtel Epoxid-Spachtelmasse in die Fuge.
6. Entfernen Sie die überschüssige Spachtelmasse mit einem in warmem Wasser und Alkohol angefeuchteten Schwamm.

Esta solución incluye el perfilado de las losas en 45°.

Para ejecutar un acabado de arista estéticamente apropiado sin el uso de perfiles, proceder de la siguiente manera:

1. Extender el adhesivo sobre el soporte.
2. Colocar la primera losa; a continuación colocar la segunda, utilizando crucetas de 1 mm.
3. Una vez que el adhesivo se ha fijado, ejecutar con una amoladora manual el acabado de la arista, eliminando la parte excedente.
4. Con un tampón o una almohadilla diamantada eliminar los bordes cortantes de la losa.
5. Con una espátula extender estuco epoxi en la junta.
6. Eliminar los excesos de estuco usando una esponja mojada con agua caliente y alcohol.

Это решение предусматривает скос плит под 45°.

Оно позволяет получать эффектную отделку кромки без использования профилей, для чего необходимо выполнить следующие действия.

1. Нанесите клей на основу.
2. Уложите первую плитку, затем приложите вторую, используя крестики 1 мм.
3. Когда клей схватится, ручной шлифмашинкой выполните отделку кромки, удалив острый угол.
4. При помощи притирки или алмазной губки отделайте острые кромки плитки.
5. Затрите шов эпоксидной затиркой, используя для этого шпатель.
6. Удалите излишки затирки губкой, смоченной теплой водой со спиртом.

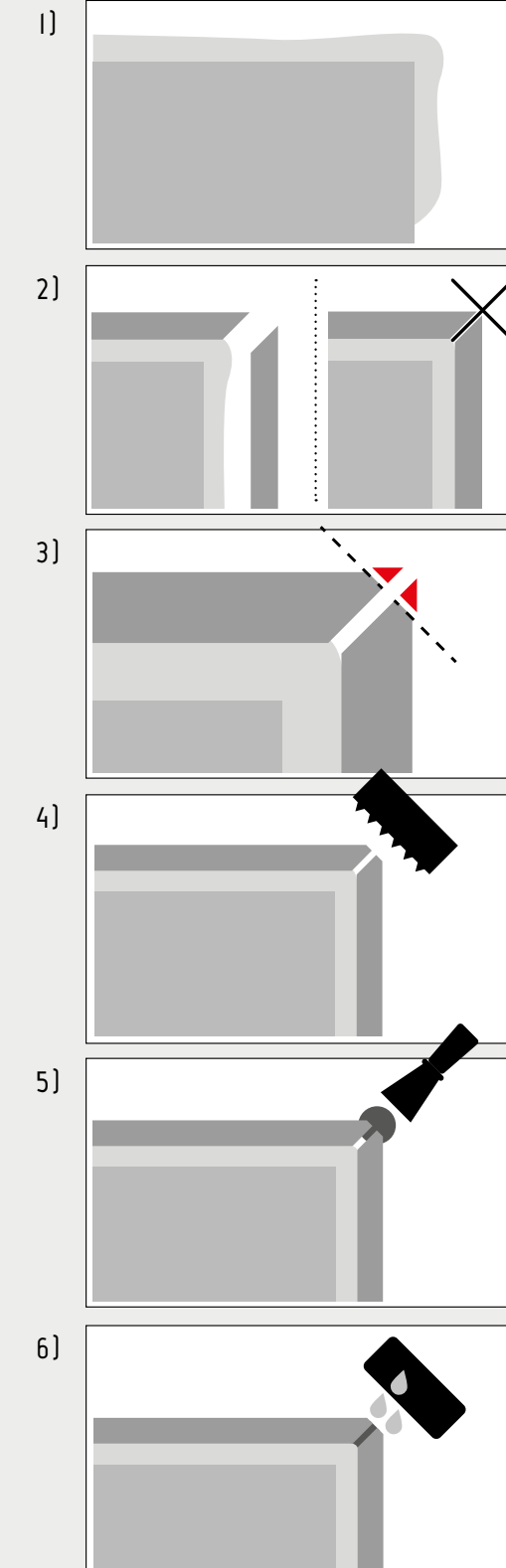

Gli angoli a 45°

45° angles.
Les angles à 45°.
Die Ecken zu 45°.
Los ángulos en 45°.
Углы под 45°.

Gli angoli a 45° sono necessari per ottenere i raccordi tra le diverse sagomature e rendere monoblocco il lavorato (velette coste laterali verticali - vaschette integrate). Lo spigolo ottenuto deve poi essere smussato manualmente con apposito utensile. La lucidatura finale della costa (solo per lastre in 12 mm) verrà effettuata con mole lucidanti in sequenza crescente di forza abrasiva. La jollatura della lastra avviene con l'apposito accessorio da montare nella barra di taglio.

- Procedere lentamente a jollare con una velocità costante lungo tutto il bordo della lastra.
- Rifinire infine con un tampone o un pads diamantato i bordi taglienti della lastra.

45° cuts are needed for the joints between the various shapes and to make the finished item into a single element (panels to conceal vertical side edges, built-in containers/sinks etc). The edge obtained must then be bevelled manually with a suitable tool and final-polished (only the 12 mm slabs) using polishing wheels with increasing order of strength. Cut the slab with a 45° angle using the cutting bar accessory.

- Proceed by slowly cutting at a 45° angle, at a constant speed, along the entire edge of the slab.
- Lastly, hone the slab's sharp edges with a rubber pad or a diamond pad.

Les angles à 45° sont nécessaires pour réaliser les raccords entre les différents façonnages et obtenir un ouvrage monobloc (retombées chants latéraux verticaux - cuvettes intégrées). L'arête obtenue doit ensuite être adoucie manuellement avec un outil spécifique. Le polissage final du chant (uniquement pour les dalles d'une épaisseur de 12 mm) sera réalisé à l'aide de meules lustrantes en augmentant progressivement la force abrasive. Commencer le biseautage de la dalle en utilisant l'accessoire prévu à monter sur la barre de coupe.

- Biseauter lentement le bord de la dalle à une vitesse constante.
- Enfin, finir les bords tranchants de la dalle avec un tampon ou un pads diamanté.

Die Ecken zu 45° sind erforderlich, um die Anschlüsse zwischen den verschiedenen Formen herzustellen und das hergestellte Produkt zu einem Teil zu machen (Verkleidung von seitlichen senkrechten Längsseiten - eingelassene Becken). Die erzielte Kante muss dann manuell mit einem dazu dienenden Werkzeug abgeschrägt werden. Das abschließende Polieren der Längskante (nur bei Platten zu 12 mm) wird mithilfe von polierenden Schleifscheiben mit zunehmender Abtriebkraft ausgeführt. Der Eckschnitt wird an der Platte mit dem dazu dienenden Zubehör ausgeführt, das an der Schneidstange montiert wird.

- Führen Sie den Eckschnitt langsam mit konstanter Geschwindigkeit entlang des gesamten Plattenrandes aus.
- Nehmen Sie schließlich mit einem Puffer oder einer Diamantscheibe die Feinbearbeitung der scharfen Kanten der Platte vor.

Los ángulos en 45° son necesarios para obtener las uniones entre las diferentes formas y convertir en monobloque las piezas trabajadas (velos borde laterales verticales / cubetas integradas). La arista obtenida debe ser achaflanada manualmente con la respectiva herramienta. El lustrado final del borde (solo para losas de 12 mm) deberá efectuarse con muelas lustradoras en secuencia creciente de fuerza abrasiva. La ejecución en 45° de la losa se ejecuta con el respectivo accesorio a montar en la barra de corte.

- Proceder lentamente en la ejecución del ángulo, con velocidad constante a lo largo de todo el borde de la losa.
- Por último, emplear un tampón o una almohadilla diamantada para realizar el acabado de los bordes cortantes de la losa.

Углы под 45° необходимы для сопряжения разных форм и придания изделию вида моноблока (вертикальные кромки торцов, встроенные емкости). В последующем полученная кромка должна быть закруглена вручную специальным приспособлением. Окончательная полировка кромки (только для плит толщиной 12 мм) будет выполняться абразивными кругами с возрастающим абразивным действием. Скос плиты осуществляется при помощи специального аксессуара, который устанавливается на режущую штангу.

- Медленно выполните скос на постоянной скорости вдоль всей кромки плиты.
- Наконец, при помощи притирки или алмазной губки отшлифуйте острые кромки плиты.

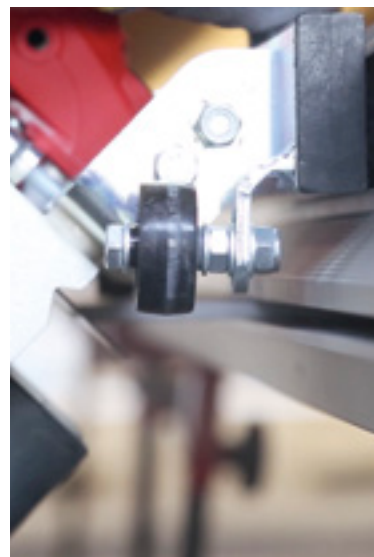

I fori per gli scassi

Holes for cutouts.
Les niches d'encastrement.
Die Bohrungen für die Aussparungen.
Los agujeros para las muescas.
Отверстия для вырезов.

Durante la progettazione del piano considerare una distanza minima di 5 cm dai bordi esterni per la realizzazione di forature per la rubinetteria e degli scassi dal bordo e in prossimità di aperture contigue (doppio lavello o piano cottura). Gli angoli interni devono avere una raggiatura minima di 5 mm (vedi figura). I bordi superiori esterni vanno sempre smussati con rompifilo.

During the top design stage, when making the holes for the taps and the cutouts apply a minimum distance of 5 cm from the outer edges, with respect to the edges and in the event of a series of cutouts (double sink or opening for a hob). The inner corners must have a minimum radius of 5 mm (see figure) The top outer edges must always chamfered.

Durant la conception du plan de travail, tenir compte d'une distance minimale de 5 cm des bords externes pour la réalisation des perçages pour la robinetterie et des niches d'encastrement à partir du bord et à proximité d'ouvertures contiguës (double évier ou plan de cuisson). Les angles internes doivent présenter un rayon minimum de 5 mm (voir figure). Les bords supérieurs externes doivent toujours être arrondis avec un casse-fil.

Berücksichtigen Sie beim Entwurf der Fläche einen Mindestabstand von 5 cm von den Außenrändern zur Herstellung von Bohrungen für die Armaturen und die Aussparungen vom Rand und in der Nähe angrenzender Öffnungen (doppeltes Spülbecken oder Kochfeld). Die Innenecken müssen einen Mindestradius von 5 mm aufweisen (siehe Abbildung). Die oberen Außenränder müssen immer mittels Kantenbrechen abgeschrägt werden.

Durante el diseño del plano considerar una distancia mínima de 5 cm respecto de los bordes externos para ejecutar las perforaciones de la grifería y las muescas desde el borde y en proximidad de aberturas contiguas (doble fregadero o plano de cocción). Las esquinas internas deben tener un radio mínimo de 5 mm (véase figura). Los bordes superiores externos deben ser siempre acabados con ejecución de chaflán.

При проектировании столешницы учитывайте минимальное расстояние в 5 см от наружных кромок для сверления отверстий под краны и для изготовления вырезов, а также при выполнении расположенных друг рядом с другом вырезов (двойная мойка или плита). Внутренние кромки должны иметь минимальный радиус 5 мм (см. рис.). Верхние кромки должны всегда иметь фаску.

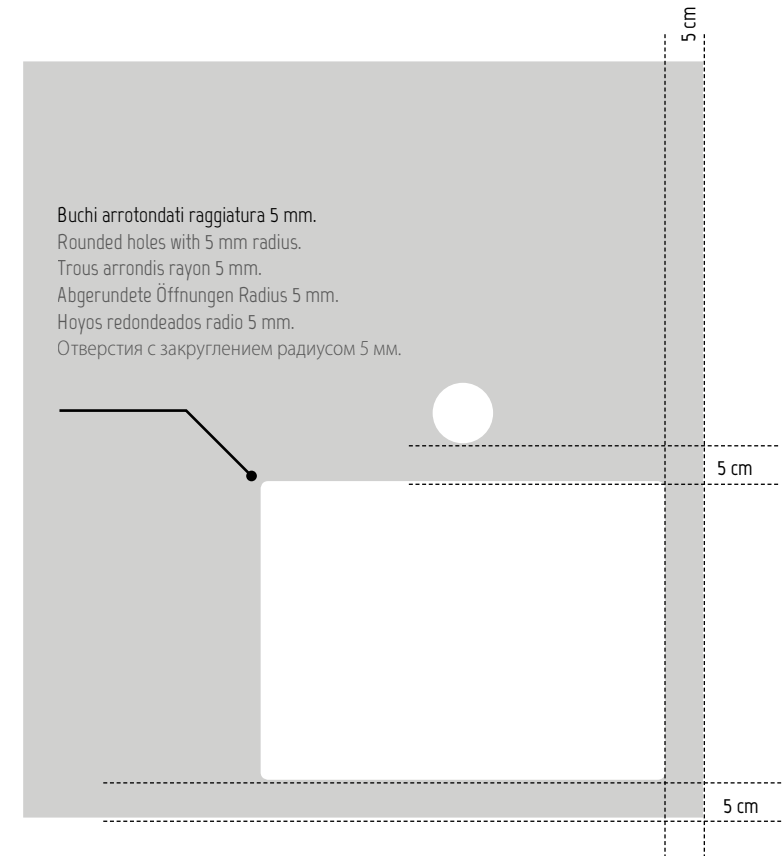

Foratura circolare

Circular holes.
Perçage circulaire.
Runde Aussparung.
Perforación circular.
Изготовление круглых отверстий.

Con una fresa diamantata iniziare a realizzare il foro con la funzione percussione disattivata, incidendo la lastra con un'angolazione di circa 75°.

Raddrizzare lentamente il trapano continuando a farlo oscillare con cautela e avendo cura di mantenere sempre bagnata sia la fresa che la lastra.

Using a diamond bur, start cutting the hole with the hammer drill function switched off, cutting the slab at an angle of approximately 75°.

Slowly straighten the drill, moving it carefully from side to side and taking care to keep both the bur and the slab wet.

Au moyen d'une fraise diamantée, commencer le perçage sans activer la fonction de percussion, en coupant la dalle avec une orientation d'environ 75°.

Redresser lentement la perceuse en continuant à la faire osciller avec prudence et en veillant à mouiller constamment la fraise et la dalle.

Beginnen Sie mit einer Diamantfräse die Bohrung bei deaktivierter Schlagbohr-Funktion herzustellen und schneiden Sie die Platte in einem Winkel von etwa 75° ein.

Richten Sie den Bohrer langsam gerade und lassen Sie ihn weiter vorsichtig schwingen, wobei darauf zu achten ist, sowohl die Fräse als auch die Platte immer nass zu halten.

Con una fresa diamantada comenzar a realizar el agujero, manteniendo la función percusión desactivada y operando en la losa con un ángulo de unos 75°.

Enderezar lentamente el taladro, continuando a hacerlo oscilar con cautela, cuidando mantener siempre mojadas tanto la broca como la losa.

При помощи алмазной фрезы начните изготовление отверстия при отключенной функции перфоратора, надрезая плиту под углом около 75°.

Медленно выпрямляйте дрель, продолжая осторожно ее покачивать из стороны в сторону, обращая внимание на то, чтобы как фреза, так и плита всегда были смоченными.



Foratura rettangolare

Rectangular holes.
Perçage rectangulaire.
Rechteckige Aussparung.
Perforación rectangular.
Изготовление прямоугольных отверстий.

Per prima cosa segnare con una matita il foro rettangolare da realizzare.

Con un trapano con punta diamantata di 6-7 mm e con la funzione percussione disattivata, incidere la lastra con un'angolazione iniziale di circa 75°.

Procedere poi con la realizzazione del foro, imprimendo una pressione costante e facendo oscillare lentamente il trapano.

È molto importante tenere bagnata con acqua sia la punta del trapano, sia la lastra.

Procedere con il taglio lungo la linea tracciata, utilizzando un flessibile con disco diamantato.

First of all, using a pencil, mark out the rectangular hole required.

Using a drill with a diamond bit (6-7 mm), start cutting the slab with the hammer drill function switched off, working at an initial angle of approximately 75°.

Then proceed to cut out the hole, applying constant pressure and carefully moving the drill from side to side.

It is very important to keep both the drill bit and the slab wet.

Proceed by cutting along the marked line, using an angle grinder with a diamond disc fitted.

Tout d'abord, marquer le trou rectangulaire à réaliser avec un crayon.

Avec une perceuse à foret diamanté de 6-7 mm et sans activer la fonction de percussion, couper la dalle avec une orientation initiale de 75°.

Ensuite, réaliser le perçage à une pression constante et en faisant osciller lentement la perceuse. Il est très important de mouiller constamment le foret de la perceuse et la dalle.

Réaliser la coupe le long de la ligne tracée en utilisant une meule à disque diamanté.

Zeichnen Sie zuerst mit einem Bleistift die herzustellende rechteckige Aussparung auf.

Schneiden Sie die Platte mit einer Bohrmaschine mit Diamantbohrer zu 6-7 mm und bei deaktivierter Schlagbohr-Funktion in einem anfänglichen Winkel von etwa 75° ein.

Stellen Sie dann die Bohrung bei konstantem Druck her und lassen Sie dabei die Bohrmaschine langsam schwingen.

Es ist äußerst wichtig, sowohl den Bohrer als auch die Platte nass zu halten.

Führen Sie den Schnitt entlang der angezeichneten Linie mittels eines Trennschleifers mit Diamantscheibe.

Ante todo marcar con un lápiz el agujero rectangular a realizar.

Con un taladro con punta diamantada de 6-7 mm y, con la función percusión desactivada, cortar la losa con un ángulo inicial de unos 75°.

Proceder a continuación a realizar el agujero, imprimiendo una presión constante y haciendo oscilar lentamente el taladro.

Es muy importante mantener mojada con agua tanto la broca del taladro como la losa.

Proceder ejecutando el corte a lo largo de la línea trazada, utilizando un flexible con disco diamantado.

Прежде всего, необходимо отметить карандашом прямоугольное отверстие, которое должно быть выполнено.

Дрелью с алмазным сверлом диаметром 6-7 мм при отключенной функции перфоратора надрежьте плиту под начальным углом около 75°.

Затем просверлите отверстие, оказывая постоянный нажим и медленно покачивая дрель.

Чрезвычайно важно, чтобы как сверло, так и плита были постоянно смоченными водой.

Выполните прорезь вдоль отмеченной линии при помощи шлифмашинки с алмазным диском.





A

LAVANDINO:
Washbasin
Vasque
Waschbecken
Fregadero
Умывальник

Marmi
Statuario Splendente
Lap. Ret.
6 mm

B

RIVESTIMENTO:
Wall tiling
Revêtement
Verblendung
Revestimiento
Облицовка

Marmi
Statuario Splendente
Lap. Ret.
6 mm



Facciate ventilate e incollate

Direct-bonded external wall tiles and curtain walls

Façades ventilées et collées

Hinterlüftete und verklebte Fassaden

Fachadas ventiladas y encoladas

Вентилируемые и наклеиваемые фасады

La Fabbrica S.p.A. è in grado di fornire, chiavi in mano tramite i suoi partner distributori, l'installazione di pareti ventilate e incollate ad alta tecnologia produttiva fino al formato massimo della lastra 320x160 cm.

In particolare è in grado di fornire un sistema unico nel suo genere di parete ventilata a fuga "zero nominale" (fuga reale 0.7 mm, © Brevetto n. TO2006A000548).

La Fabbrica S.p.A. est en mesure de procéder, clés en main par l'intermédiaire de ses partenaires distributeurs, à l'installation de murs ventilés et collés à haute technologie de production jusqu'au format maximum de la dalle de 320x160 cm.

En particulier, elle est en mesure de fournir un système unique en son genre consistant en une paroi ventilée à joint "zéro nominal" (joint réel 0,7 mm, © Brevet n° TO2006A000548).

Through its distributors, La Fabbrica S.p.A. offers a turnkey solution for the installation of curtain walls and direct-bonded external wall tiles, manufactured using advanced technology and available in sizes of up to 320x160 cm.

In particular, the company offers a totally unique system for the production of 'seamless' curtain walls (special system featuring inter-tile gaps measuring just 0.7 mm, covered by © patent number n. TO2006A000548).

Die Firma Fabbrica S.p.A. ist in der Lage, über ihre Vertriebspartner schlüsselfertige Installationen von hinterlüfteten und verklebten Wänden mit hoher Produktionstechnologie bis zum maximalen Format der Platte von 320x160 cm.

Im Besonderen kann sie ein einzigartiges System einer hinterlüfteten Wand mit "Nennfuge Null" (reelle Fuge 0,7 mm, © Patent Nr. TO2006A000548) liefern.

La Fabbrica S.p.A. está en condiciones de realizar, con entrega llave en mano a través de sus colaboradores distribuidores, la instalación de paredes ventiladas y encoladas de alta tecnología productiva, con formato máximo de losa 320 x 160 cm.

En particular, puede suministrar un sistema único en su género de pared ventilada con junta "cero nominal" (junta efectiva 0,7 mm, © patente n° TO2006A000548).

Через своих партнеров-дистрибьюторов компания La Fabbrica S.p.A. способна осуществлять установку вентиляруемых и наклеиваемых фасадов, в производстве которых используется высокая технология, вплоть до максимального формата плиты 320x160 см.

В частности, она способна поставлять единственную в своем роде систему вентиляруемого фасада с "нулевой шириной шва" (реальная ширина шва 0,7 мм, © патент № TO2006A000548).



PARETE VENTILATA:
Curtain wall
Mur ventilé
Hinterlüftete Wand
Pared ventilada
Вентилируемый фасад

Contemporanei
Metal Pearl
120x60 Nat. Ret.
10 mm

I Vantaggi delle facciate ventilate

The advantages of curtain walls.
 Les avantages des façades ventilées.
 Die Vorteile der hinterlüfteten Fassaden.
 Las ventajas de las fachadas ventiladas.
 Преимущества вентилируемых фасадов.



PARETE VENTILATA:
 Curtain wall
 Mur ventilé
 Hinterlüftete Wand
 Pared ventilada
 Вентилируемый фасад

Materico
 Skyline Chiaccio
 320x160 Nat. Ret.
 6 mm

I vantaggi delle facciate incollate

The advantages of external wall tiles mounted with a direct bonding method.
 Les avantages des façades collées.
 Die Vorteile der verklebten Fassaden.
 Las ventajas de las fachadas encoladas.
 Преимущество наклеиваемых фасадов.



PARETE POSA A COLLA:
 Wall tiles mounted with direct bonding method
 Mur pose à la colle
 Verklebte Wand
 Pared fijación con cola
 Стена с укладкой облицовки на клей

Marmo e Pietra
 Copacabana Duke
 320x160 Nat. Ret.
 6 mm

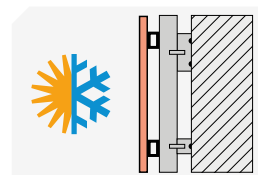

MIGLIOR ISOLAMENTO TERMICO DELL'EDIFICIO

BETTER THERMAL INSULATION.
 ISOLATION THERMIQUE AMÉLIORÉE DU BÂTIMENT.
 BESSERE WÄRMEDÄMMUNG DES GEBÄUDES.
 MAYOR AISLAMIENTO TÉRMICO DEL EDIFICIO.
 ЛУЧШАЯ ТЕПЛОИЗОЛЯЦИЯ ЗДАНИЯ.

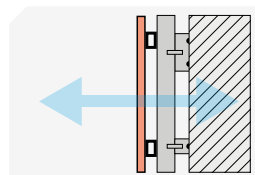

MIGLIOR SALUBRITÀ ABITATIVA

HEALTHIER HOMES
 SALUBRITÉ AMÉLIORÉE.
 BESSERES WOHNRAUMKLIMA.
 MAYOR SALUBRIDAD HABITACIONAL.
 БОЛЕЕ ЗДОРОВЫЕ УСЛОВИЯ ПРОЖИВАНИЯ.

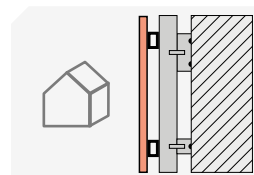

UNA SOLUZIONE EFFICACE PER RISTRUTTURARE

EFFECTIVE OPTION FOR RENOVATIONS.
 UNE SOLUTION EFFICACE POUR RESTRUCTURER.
 EINE EFFIZIENTE LÖSUNG FÜR DIE SANIERUNG.
 UNA SOLUCIÓN EFICAZ PARA REESTRUCTURAR.
 ЭФФЕКТИВНОЕ РЕШЕНИЕ ДЛЯ РЕКОНСТРУКЦИИ.

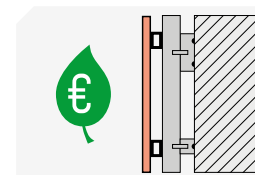

RIDUZIONE DEI COSTI ENERGETICI

LOWER CLIMATE CONTROL BILLS.
 RÉDUCTION DES COÛTS ÉNERGÉTIQUES.
 REDUZIERUNG DER ENERGIEKOSTEN.
 REDUCCIÓN DE COSTOS ENERGÉTICOS.
 СНИЖЕНИЕ ЭНЕРГЕТИЧЕСКИХ РАСХОДОВ.

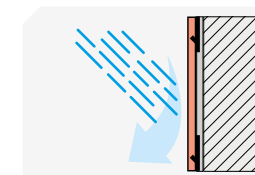

PROTEGGE LE STRUTTURE PRIMARIE DALL'ACQUA

PROTECTS PRIMARY STRUCTURES AGAINST WATER.
 PROTÈGE LES STRUCTURES PRIMAIRES CONTRE L'EAU.
 SCHÜTZT DIE GRUNDSTRUKTUREN VOR WASSER.
 PROTEGE LAS ESTRUCTURAS PRIMARIAS CONTRA EL AGUA.
 ЗАЩИЩАЕТ ОСНОВНЫЕ КОНСТРУКЦИИ ОТ ВОДЫ.

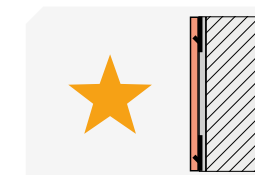

NESSUN DETERIORAMENTO ESTETICO E TECNICO

NO LOSS OF LOOKS OR TECHNICAL WEAR.
 AUCUNE DÉTÉRIORATION ESTHÉTIQUE ET TECHNIQUE.
 KEINE ÄSTHETISCHE UND TECHNISCHE VERSCHLECHTERUNG.
 NINGÚN DETERIORO ESTÉTICO O TÉCNICO.
 ОТСУТСТВИЕ УХУДШЕНИЯ ЭСТЕТИЧЕСКИХ И ТЕХНИЧЕСКИХ ХАРАКТЕРИСТИК.

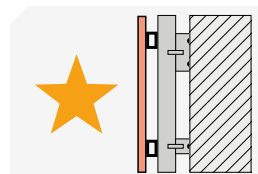

NESSUN DETERIORAMENTO ESTETICO E TECNICO

NO LOSS OF LOOKS OR TECHNICAL WEAR.
 AUCUNE DÉTÉRIORATION ESTHÉTIQUE ET TECHNIQUE.
 KEINE ÄSTHETISCHE UND TECHNISCHE VERSCHLECHTERUNG.
 NINGÚN DETERIORO ESTÉTICO O TÉCNICO.
 ОТСУТСТВИЕ УХУДШЕНИЯ ЭСТЕТИЧЕСКИХ И ТЕХНИЧЕСКИХ ХАРАКТЕРИСТИК.

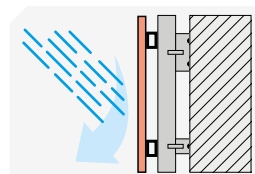

PROTEGGE LE STRUTTURE PRIMARIE DALL'ACQUA

PROTECTS PRIMARY STRUCTURES AGAINST WATER.
 PROTÈGE LES STRUCTURES PRIMAIRES CONTRE L'EAU.
 SCHÜTZT DIE GRUNDSTRUKTUREN VOR WASSER.
 PROTEGE LAS ESTRUCTURAS PRIMARIAS CONTRA EL AGUA.
 ЗАЩИЩАЕТ ОСНОВНЫЕ КОНСТРУКЦИИ ОТ ВОДЫ.

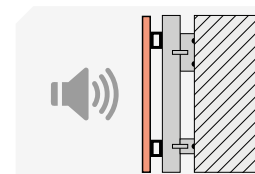

MIGLIORE ISOLAMENTO ACUSTICO

BETTER NOISE INSULATION.
 ISOLATION ACOUSTIQUE AMÉLIORÉE.
 BESSERE SCHALLDÄMMUNG.
 MAYOR AISLAMIENTO ACÚSTICO.
 ПОВЫШЕННАЯ ЗВУКОИЗОЛЯЦИЯ.

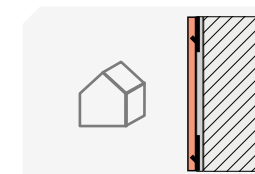

UNA SOLUZIONE EFFICACE PER RISTRUTTURARE

EFFECTIVE OPTION FOR RENOVATIONS.
 UNE SOLUTION EFFICACE POUR RESTRUCTURER.
 EINE EFFIZIENTE LÖSUNG FÜR DIE SANIERUNG.
 UNA SOLUCIÓN EFICAZ PARA REESTRUCTURAR.
 ЭФФЕКТИВНОЕ РЕШЕНИЕ ДЛЯ РЕКОНСТРУКЦИИ.

Sistemi di ancoraggio delle facciate ventilate

Anchorage systems for curtain walls.
Systèmes d'ancrage des façades ventilées.
Verankerungssysteme der hinterlüfteten Fassaden.
Sistemas de anclaje de las fachadas ventiladas.
Системы анкерования вентилируемых фасадов.

AGGANCIO MECCANICO A VISTA

Exposed mechanical hooks.
Accrochage mécanique visible.
Sichtbare mechanische Befestigung.
Enganche mecánico a la vista.
Видимое механическое крепление.

È il metodo più semplice ed economico. Non richiede nessun intervento di preparazione delle lastre che vengono montate direttamente con appositi ganci a vista su una struttura di montanti verticali distanziati in base alla larghezza della lastra.

This is the easiest and cheapest method. No preparation is required for the slabs, which are simply fastened (using exposed hooks) onto a framework of vertical posts, spaced according to the width of the slab.

Il s'agit de la méthode la plus simple et meilleur marché. Elle n'exige aucune intervention de préparation des dalles qui sont directement montées avec des crochets visibles spéciaux sur une structure de montants verticaux espacés suivant la largeur de la dalle.

Dies ist die einfachste und kostengünstigste Methode. Sie erfordert keine Maßnahme zur Vorbereitung der Platten, die direkt mit dazu dienenden unverdeckten Haken auf einer Konstruktion senkrechter Träger montiert werden, deren Abstand von der Plattenbreite abhängig ist.

Es el método más sencillo y económico. No requiere ninguna intervención de preparación de las losas, las que son montadas directamente con ganchos especiales a la vista sobre una estructura de montantes verticales distanciados en función de la anchura de la losa.

Это - самый простой и экономичный метод. Он не требует какой-либо подготовки плит, которые устанавливаются непосредственно при помощи видимых креплений на конструкцию из вертикальных стоек, расстояние между которыми равно ширине плиты.

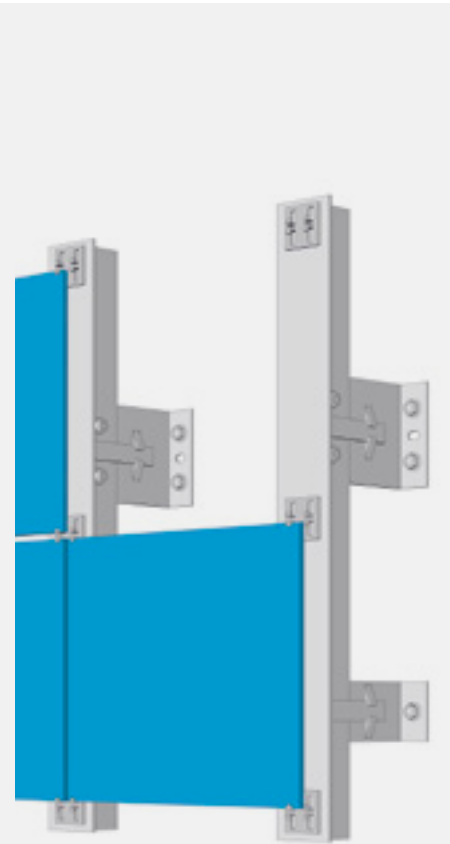

AGGANCIO MECCANICO A SCOMPARS A FORATURA PUNTUALE

Concealed mechanical fastening with specific boring.
Accrochage mécanique escamotable à perçage ponctuel.
Verdeckte mechanische Befestigung mit Punktbohrungen.
Enganche mecánico oculto de perforación en puntos.
Скрытое механическое крепление с глухими отверстиями.

Sistema di agganci nascosti per lastre 12 mm che prevede la preparazione del retro con 4 incavi circolari svasati a tronco conico. Negli incavi vengono inseriti dei tasselli ad espansione che tramite agganci specifici ancorano la lastra a una struttura composta da montanti verticali e da profili orizzontali.

This concealed hook system for 12 mm-thick slabs requires the rear of the slabs to be prepared with four countersunk circular recesses with a tapered shaft. Expansion bolts are fitted into the recesses and then, using special hooks, they anchor the slab to a structure consisting of vertical posts and horizontal section bars.

Système d'accrochages dissimulés pour les dalles de 12 mm qui prévoit la préparation du verso des dalles en réalisant 4 rainures circulaires évasées à tronc conique. On introduit dans les cavités des chevilles à expansion qui ancrent, par l'intermédiaire d'accrochages spécifiques, la dalle à une structure constituée par des montants verticaux et des profils horizontaux.

System mit verdeckten Befestigungen für Platten zu 12 mm, das die Vorbereitung der Rückseite der Platten mit 4 runden, angeschrägten, kegelförmigen Vertiefungen vorsieht. In die Vertiefungen werden Spreizdübel eingefügt, die mittels speziellen Verankerungen die Platte an einer Konstruktion befestigen, die aus senkrechten Trägern und waagerechten Profilen besteht.

Sistema de enganches ocultos para losas 12 mm que requiere la preparación de la parte trasera de las losas con 4 huecos circulares avellanados de tronco cónico. En los huecos se introducen tacos de expansión que, mediante enganches específicos, anclan la losa a una estructura compuesta por montantes verticales y perfiles horizontales.

Система скрытых креплений для плит толщиной 12 мм, предусматривающая подготовку тыльной стороны с изготовлением 4 круглых отверстий в виде усеченного конуса. В отверстия вставляются расширительные вставки, которые при помощи специальных креплений фиксируют плиту к конструкции, состоящей из вертикальных стоек и горизонтальных профилей.

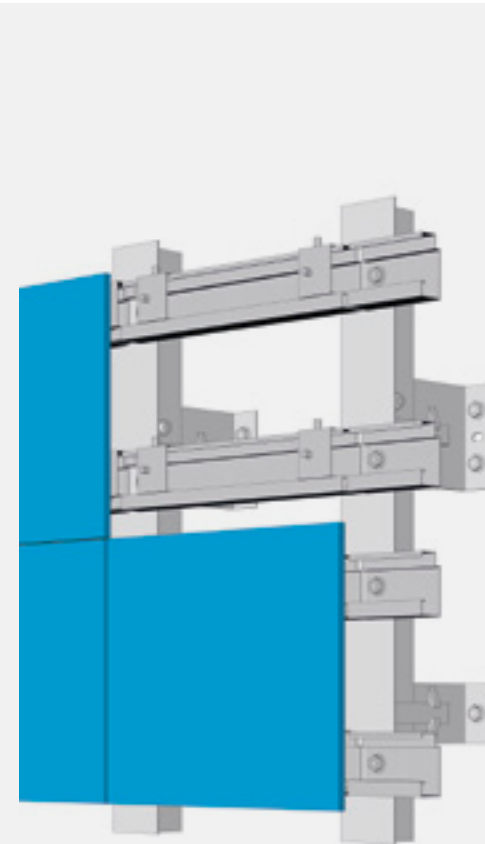

SISTEMA BREVETTATO A FISSAGGIO A SCOMPARS A FUGA ZERO NOMINALE®

Patented concealed fastening system for seamless (gap-free) tiling.
Système breveté à fixation escamotable avec joint zéro nominale.
Patentiertes verdecktes Befestigungssystem mit Nennfuge Null.
Sistema patentado de fijación oculta con junta cero nominal.
Запатентованная система скрытых креплений с нулевой шириной шва.

Il sistema high tech fissaggio a scomparsa consiste di sottostruttura in alluminio preassemblata in stabilimento alle piastrelle di rivestimento. La struttura, dotata di particolari incastri, permette adattamenti veloci e precisi in corso d'opera e la possibilità di realizzare fughe con dimensioni da 0,5 a 8 mm. Le fughe si presentano chiuse dall'alluminio retrostante, impedendo l'ingresso di polveri, acqua ed insetti vari.

The High Tech concealed fastening system consists of an aluminium substructure onto which the wall tiles are pre-mounted in the factory. The structure, equipped with special snap joints, allows quick and accurate adjustments during construction and inter-tile gaps to be created measuring from 0.5 to 8 mm. The gaps between the tiles are sealed by the aluminium behind them, stopping dust, water and insects getting inside.

Le système high tech fixation escamotable consiste en une sous-structure en aluminium préassemblée à l'usine avec les carreaux de revêtement. La structure, dotée d'encastres spéciaux, permet les adaptations rapides et précises au cours des travaux et la possibilité de réaliser des joints entre 0,5 et 8 mm. Les joints sont fermés par l'aluminium présent au verso, empêchant la pénétration de la poussière, de l'eau et des insectes.

Das System High Tech zur verdeckten Befestigung besteht aus einer Unterkonstruktion aus Aluminium, die im Werk mit den als Verkleidung dienenden Fliesen vormontiert wird. Die mit besonderen Steckverbindungen versehene Struktur ermöglicht schnelle und präzise Anpassungen während des Arbeitsablaufs und die Ausbildung von Fugen mit Abmessungen von 0,5 bis 8 mm. Die Fugen werden vom dahinter befindlichen Aluminium verschlossen, wodurch das Eindringen von Staub, Wasser und Insekten aller Art verhindert wird.

El sistema high tech de fijación oculta está formado por subestructura en aluminio preensamblado en fábrica en las losas de revestimiento. La estructura, provista de particulares uniones, permite efectuar adaptaciones rápidas y precisas durante la ejecución del trabajo, además de la posibilidad de obtener juntas con dimensiones de 0,5 a 8 mm. Las juntas se presentan cerradas por el aluminio ya presente, impidiendo así la entrada de polvo, agua e insectos.

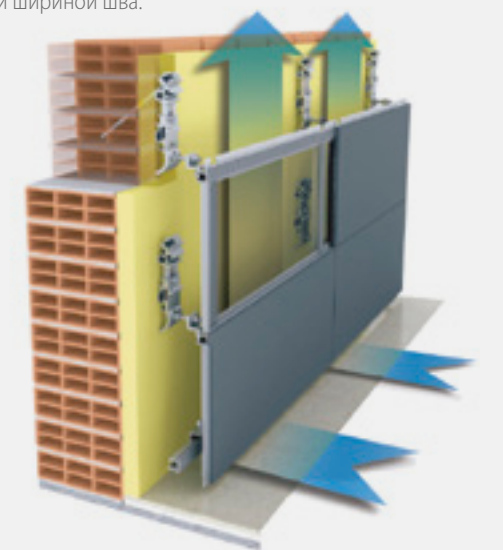

Система High Tech со скрытыми креплениями состоит из алюминиевой несущей конструкции с установленной в заводских условиях облицовочной плиткой. Эта конструкция с особыми креплениями позволяет выполнять быструю и точную подгонку во время работы, а также предоставляет возможность изготовления швов шириной от 0,5 до 8 мм. Швы закрываются находящимся за ними алюминием, предотвращая проникновение пыли, воды и насекомых.

Sistemi di ancoraggio della posa a colla in facciata

Anchorage systems for external wall tiles mounted with direct bonding method.
 Systèmes d'ancrage de la pose à la colle sur les façades.
 Verankerungssysteme der verklebten Fassaden.
 Sistemas de anclaje para colocación con cola en fachada.
 Система анкеровки уложенной на клей облицовки фасада.

AGGANCI DI SICUREZZA A SCOMPARSA

Concealed safety hooks.
 Accrochages de sécurité escamotables.
 Verdeckte Sicherheitsverankerungen.
 Enganches de seguridad ocultos.
 Скрытые предохранительные крепления.

I supporti metallici "nascosti" possono essere inseriti preventivamente alle lastre tramite micro incisione sul retro (da realizzarsi in appositi laboratori), calcolandone il numero in proporzione al formato da utilizzarsi, per poi essere annegati nel collante e agganciati con apposito tassello o chiodi conici.

La placca in acciaio inox di 0,5 mm di spessore viene agganciata nella fresata sul retro lastra (di solito 2 per lastra in prossimità degli angoli superiori, salvo diverse disposizioni), risultando completamente a scomparsa. In alternativa si possono utilizzare i ganci a vista con fissaggio meccanico alla parete.

These "hidden" metal supports can be fitted on the slabs beforehand via micro-scoring on the rear of the slab (which must be performed in special processing centres), calculating the number required in proportion to the size of the slabs due to be used, and can then be embedded in the adhesive and hooked with a special anchor or tapered nails.

The 0.5 mm thick stainless steel plate is hooked into the milled part on the rear of the slab (usually two plates per slab, positioned near the upper corners, unless specified otherwise), and are therefore completely hidden. Alternatively, you can use the hooks, with an exposed technique, fastened mechanically to the wall.

Les supports métalliques "dissimulés" peuvent être préalablement introduits dans les dalles en réalisant une micro-incision au dos (dans des laboratoires spécifiques), en en calculant le nombre proportionnellement au format à utiliser, puis ils sont noyés dans la colle et accrochés au moyen d'une cheville spéciale ou de clous coniques.

La plaque en acier inox d'une épaisseur de 0,5 mm est accrochée dans le fraisage au dos de la dalle (généralement 2 fraisages par dalle à proximité des coins supérieurs, sauf dispositions contraires), et elle est entièrement escamotable. En alternative, on peut utiliser les crochets visibles avec fixation mécanique au mur.

Die "verdeckten" Halterungen aus Metall können mittels eines Mikro-Einschnitts auf der Rückseite vorab in die Platten eingefügt werden (in speziellen Werkstätten auszuführen), wobei die Anzahl proportional zum zu verwendenden Format berechnet wird. Danach werden diese im Klebstoff versenkt und mit zugehörigem Dübel oder konischen Nägeln eingehängt.

Die Edelstahlscheibe von 0,5 mm Stärke wird in der Fassade auf der Rückseite der Platte eingehängt (gewöhnlich 2 pro Platte in der Nähe der oberen Ecken, vorbehaltlich anderer Festlegungen), wodurch sie vollkommen verdeckt ist. Anderenfalls können unverdeckte Haken mit mechanischer Befestigung an der Wand verwendet werden.

Los soportes metálicos "ocultos" pueden ser instalados previamente en las losas mediante microincisiones en la parte trasera (a ejecutar en talleres especiales), estableciendo su número en proporción al formato a utilizar. Estos soportes deben ser fijados sumergiéndolos en cola y enganchados mediante tacos o clavos cónicos.

La placa de acero inoxidable de 0,5 mm de espesor es enganchada en las muescas de la parte trasera de la losa (en general dos por losa en proximidad de los ángulos superiores, salvo otras posibles soluciones), quedando así completamente oculta. Como alternativa, es posible utilizar los ganchos a vista con fijación mecánica a la pared.

Скрытые металлические крепления могут быть предварительно установлены на плиты при помощи микро-надрезов на тыльной стороне (выполняются в специальных цехах), рассчитывая их количество в зависимости от используемого формата, после чего они заливаются клеем и крепятся специальным дюбелем или коническими гвоздями.

Пластина из нержавеющей стали толщиной 0,5 мм вставляется в прорезь на тыльной стороне плиты (при отсутствии иных указаний, как правило, 2 на плиту, рядом с верхними углами) после чего они становятся совершенно невидимыми. В качестве альтернативы можно использовать видимые крепления с механической установкой на стену.

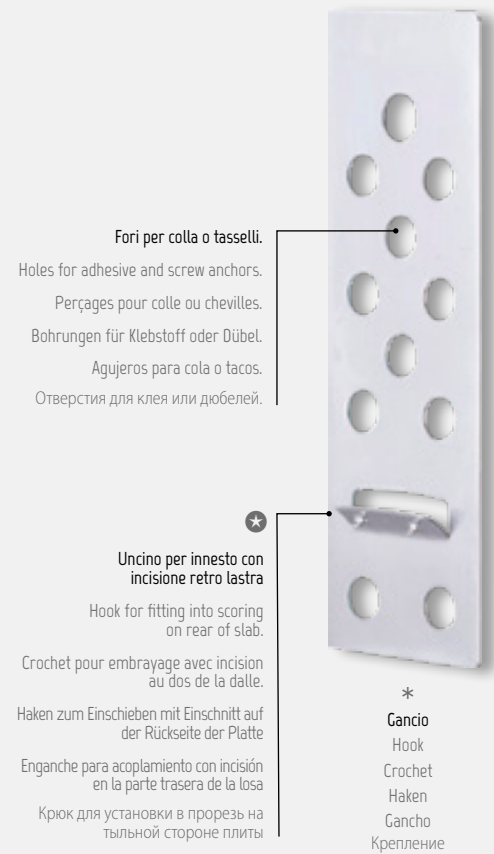
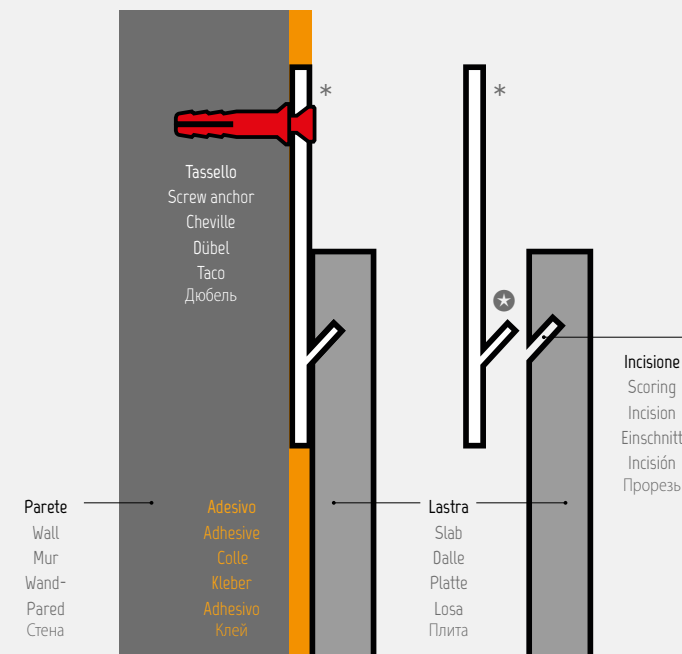

AGGANCI MECCANICI A VISTA

Exposed mechanical hooks.
 Accrochages mécaniques visibles.
 Sichtbare mechanische Befestigung.
 Enganches mecánicos a la vista.
 Наружные механические крепления.

Questo sistema, oltre l'azione della colla, prevede l'ancoraggio delle lastre tramite clips in acciaio inox fissate al muro con tasselli. Il gancio della clip rimane visibile, ma può essere smaltato del colore della lastra ed essere riconoscibile solo da una distanza ravvicinata.

In addition to the action performed by the adhesive, this system involves anchoring the slabs with stainless steel clips fixed to the wall with anchor bolts. The clip remains visible, but can be painted the same colour as the slab, in which case it is only easily seen when close up.

Outre l'action de la colle, ce système prévoit l'ancrage des dalles moyennant des clips en acier inox fixées au mur avec des chevilles. Le crochet de la clip reste visible, mais on peut le laquer de manière à ce qu'il ne soit visible qu'à une distance rapprochée.

Dieses System sieht außer dem Auftragen von Klebstoff die Verankerung der Platten mittels Clips aus Edelstahl vor, die mit Dübeln an der Mauer befestigt werden. Die Befestigung des Clip bleibt sichtbar, kann aber mit der Farbe der Platte lackiert werden und ist dann nur aus geringer Entfernung erkennbar.

Este sistema, además de la acción de la cola, requiere el anclaje de las losas mediante clips en acero inoxidable, con fijación al muro mediante tacos. El gancho del clip permanece visible, pero puede ser esmaltado en el color de la losa, quedando así visible solo a corta distancia.

Помимо действия клея, эта система предусматривает анкеровку плит при помощи клипс из нержавеющей стали, которые крепятся к стене дюбелями. Крюк клипсы находится на поверхности, но его можно покрасить в цвет плиты, после чего он будет замечен лишь только с близкого расстояния.

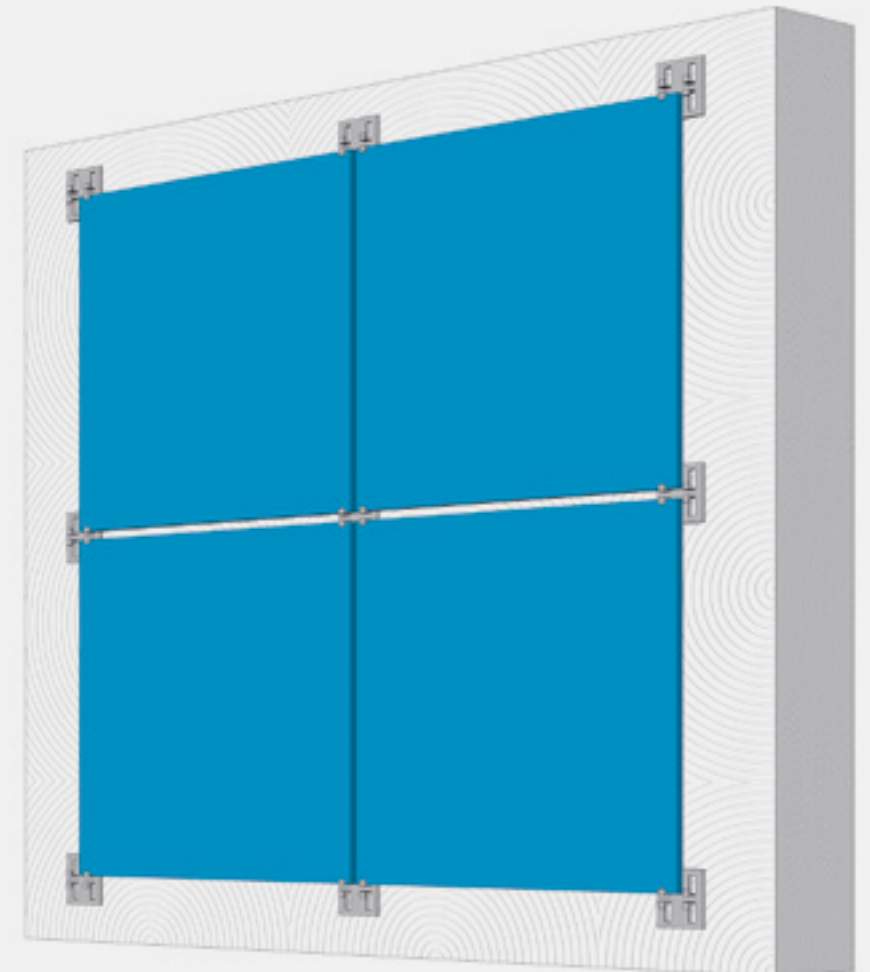
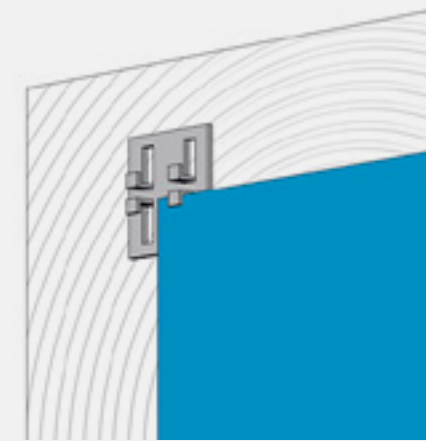

INDOOR

AESTHETICA HEGEL.....	38
AESTHETICA WILDE.....	50
ARDESIA.....	62
AZUL MACAUBA.....	70
BARDIGLIO CENERE.....	82
BRONZE AMANI.....	94
CALACATTA.....	102
COPACABANA DUKE.....	116
COPACABANA EMPEROR.....	126
COPACABANA PRINCESS.....	136
CREMA MARFIL.....	146
C-STONE.....	158
LASA.....	166
NAUTILUS.....	178
NERO BELVEDERE.....	186
ONICE SERPENTINO.....	196
ONICE SMERALDO.....	206
PIRENEI.....	214
PORTORO.....	222
STATUARIO.....	232
STATUARIO SPLENDEnte.....	246
TAJ MAHAL.....	260
TORTOISE.....	268
TRAVERTINO CLASSIC.....	276
WHITE MACAUBA.....	288



MARMO E PIETRA

Marble & Stone . Marbres et Pierres . Marmore und Steine . Mármoles y Piedras . Мрамор и Камень .

AESTHETICA HEGEL

LASTRE IN GRES PORCELLANATO PRESSATE A SECCO . DRY-PRESSED PORCELAIN STONEWARE SLABS .
 DALLES EN GRÈS CÉRAMÉ PRESSÉES À SEC . TROCKENGEPRESSTE PLATTEN AUS FEINSTEINZEUG .
 PLANCHAS EN GRÈS PORCELÁNICO PRENSADAS EN SECO . КЕРАМОГРАНИТНЫЕ ПЛИТЫ СУХОГО ПРЕССОВАНИЯ .
 UNI EN 14411-ISO 13006 - Appendice G - Gruppo BIa - UGL

100% DESIGN
 AND PRODUCTION
 OF ITALY

V2
 SHADE SPECTRUM
 MODERATE

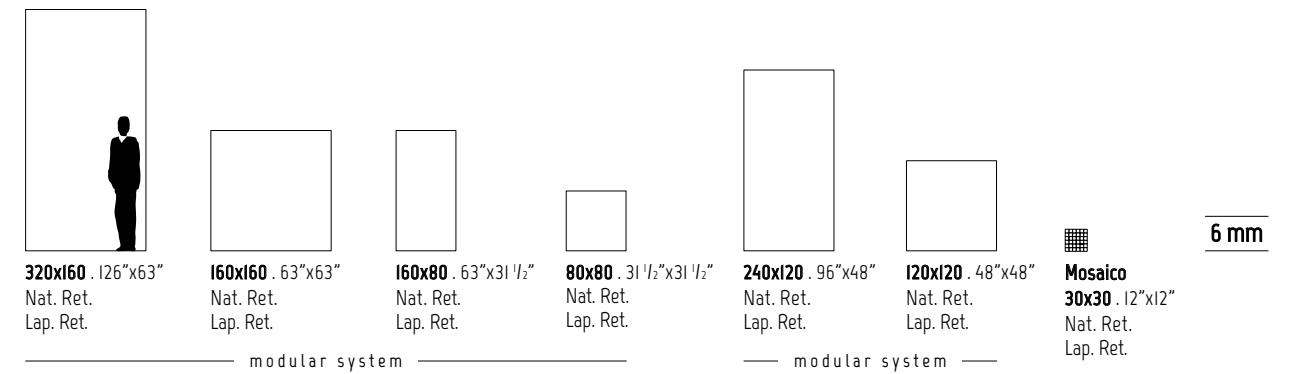

INDOOR

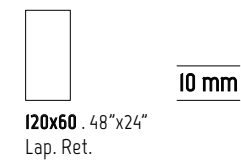

SVILUPPO GRAFICO PER FORMATO Pattern by size Développement graphique par format Grafischer Entwurf für Format Desarrollo gráfico por formato Варианты графики для каждого формата	320x160 6 mm	160x160 6 mm	160x80 6 mm	80x80 6 mm	240x120 6 mm	120x120 6 mm	120x60 10 mm
	7	14	28	55	11	22	25

AESTHETICA HEGEL

Wall
Aesthetica Wilde 320x160 (126"x63") Lap. Ret.

Floor
Aesthetica Hegel 160x160 (63"x63") Lap. Ret.



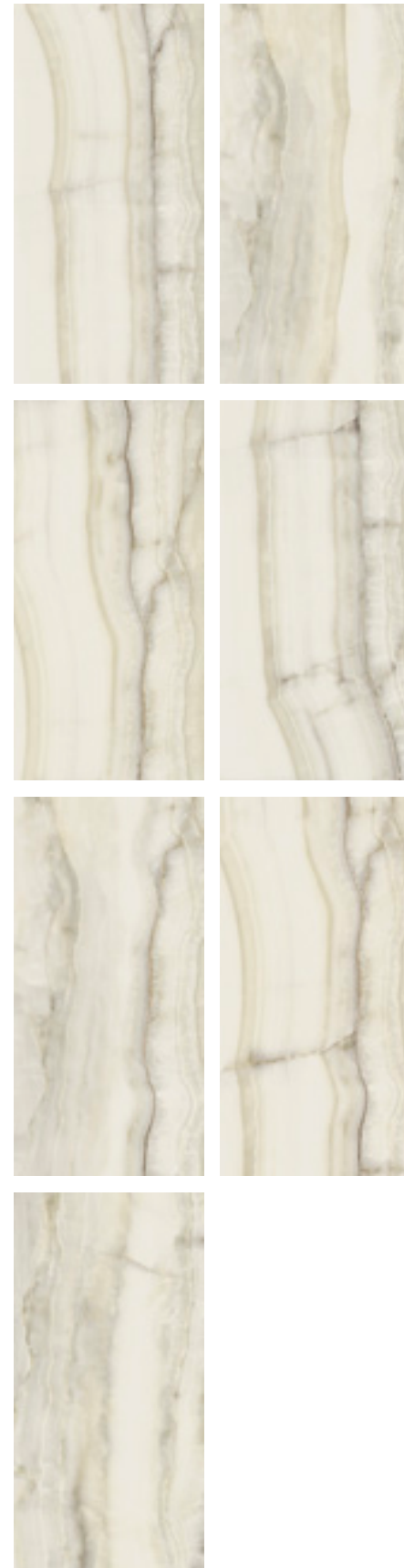

320x160
SVILUPPO GRAFICO PER FORMATO - 7 Pattern by size
 7 Développement graphique par format - 7 Grafischer Entwurf für Format
 7 Desarrollo gráfico por formato - 7 Варианты графики для каждого формата

6 mm



079002
320x160 . 126"x63"
 Nat. Ret.

079001
320x160 . 126"x63"
 Lap. Ret.



079022
160x160 . 63"x63"
 Nat. Ret.

079021
160x160 . 63"x63"
 Lap. Ret.



079042
160x80 . 63"x31 1/2"
 Nat. Ret.

079041
160x80 . 63"x31 1/2"
 Lap. Ret.



079052
80x80 . 31 1/2"x31 1/2"
 Nat. Ret.

079051
80x80 . 31 1/2"x31 1/2"
 Lap. Ret.



079012
240x120 . 96"x48"
 Nat. Ret.

079011
240x120 . 96"x48"
 Lap. Ret.



079032
120x120 . 48"x48"
 Nat. Ret.

079031
120x120 . 48"x48"
 Lap. Ret.



Mosaico
079142
30x30 . 12"x12"
 Nat. Ret.

079141
30x30 . 12"x12"
 Lap. Ret.

modular system

modular system

INDOOR

10 mm



079061
120x60 . 48"x24"
 Lap. Ret.

AESTHETICA HEHEL

6 mm

		modular system								modular system				Mosaico Mosaic		Battiscopa Skirting	Scuretto Rabbeted riser																						
		320x160 126"x63" Nat. Ret.		320x160 126"x63" Lap. Ret.		160x160 63"x63" Nat. Ret.		160x160 63"x63" Lap. Ret.		160x80 63"x31 1/2" Nat. Ret.		160x80 63"x31 1/2" Lap. Ret.		80x80 31 1/2"x31 1/2" Nat. Ret.		80x80 31 1/2"x31 1/2" Lap. Ret.		240x120 96"x48" Nat. Ret.		240x120 96"x48" Lap. Ret.		120x120 48"x48" Nat. Ret.		120x120 48"x48" Lap. Ret.		30x30 12"x12" Nat. Ret.		30x30 12"x12" Lap. Ret.		8x80 3"x31 1/2" Lap. Ret.		20x160 8"x63" Nat. Ret.		20x160 8"x63" Lap. Ret.		20x80 8"x31 1/2" Nat. Ret.		20x80 8"x31 1/2" Lap. Ret.	
AESTHETICA HEHEL		079002	079001	079022	079021	079042	079041	079052	079051	079012	079011	079032	079031	079142	079141	079245	079215	079213	079218	079217																			
PREZZO PRICE		€ 106,00 m ²	€ 130,00 m ²	€ 94,00 m ²	€ 120,00 m ²	€ 74,00 m ²	€ 102,00 m ²	€ 62,00 m ²	€ 76,00 m ²	€ 86,00 m ²	€ 108,00 m ²	€ 74,00 m ²	€ 102,00 m ²	€ 126,00 m ²	€ 168,00 m ²	€ 8,00 PZ/PCE	€ 30,00 PZ/PCE	€ 42,00 PZ/PCE	€ 22,00 PZ/PCE	€ 30,00 PZ/PCE																			
CODICE PREZZO PRICE CODE		M173	M197	M161	M187	M141	M169	M129	M143	M153	M175	M141	M169	M193	M235	P029	P077	P101	P061	P077																			
IMBALLO cm h. PACKING cm h.		345x175	330x75	182,6x173,6	330x75	168x97	EPAL 80x120	264x136,6	250x75	143x123	250x75	EPAL 80x120	Pallet 80x120	168x97	Pallet 80x120																								
Tara / Tare		140,00	210,00	71,80	210,00	-	-	100,00	158,00	-	158,00	-	-	-	-	40,9	-	-	-	-																			
N°		14	44	24	88	-	-	20	44	-	88	-	-	-	-	12	1	1	-	-																			
m ² x		5,12	5,12	2,56	2,56	-	-	2,88	2,88	-	1,44	-	-	-	-	0,77	-	-	-	-																			
Kg x		74,14	74,14	37,07	37,07	-	-	41,70	41,70	-	20,85	-	-	-	-	11,50	5	3	-	-																			
m ² x		-	-	-	-	2	3	-	-	2	-	-	12	-	-	-	-	-	-	-																			
Kg x		-	-	-	-	37,2	27,90	-	-	41,70	-	-	11,50	-	-	-	-	-	-	-																			
m ² x		71,68	225,28	61,44	225,28	38,40	76,80	57,60	126,72	69,12	126,72	-	-	-	-	-	-	-	-	-																			
Kg x		1.178	3.472	962	3.472	648	1.141	934	1.993	1.057	1.993	-	-	-	-	-	-	-	-	-																			

SOLO SUPERFICIE NATURALE
ONLY NATURAL SURFACE
ANSI A - 137.1: 2012
WET DYNAMIC COEFFICIENT OF FRICTION
DCOF ≥ 0,42



Cavalletto in legno
Wood A-Frame
Support en bois
Holzgestell
Caballete de madera
Деревянная подставка



Cassa
Crate
Caisse
Kiste
Caja
Ящик



Pallet speciale con sponde
Special pallet with sides
Palette spéciale avec bords
Spezial-Palette mit Wandungen
Palet especial con bordes
Специальный поддон с боковинами

AESTHETICA HEHEL

6 mm

SOLO SUPERFICIE NATURALE
ONLY NATURAL SURFACE
ANSI A - 137.1: 2012
WET DYNAMIC COEFFICIENT OF FRICTION
DCOF ≥ 0,42

	Gradino costa retta Straight nosed stair **						Gradino costa retta - Angolo SX / DX Straight-edge step - LH/RH corner **						Gradino Bordo Dritto Straight-edge step **						Gradino Bordo Dritto - Angolo SX / DX Straight-edge step - LH/RH corner **					
	33x160x3,2h 13"x63"x1 1/4"h Nat. Ret.	33x160x3,2h 13"x63"x1 1/4"h Lap. Ret.	33x120x3,2h 13"x48"x1 1/4"h Nat. Ret.	33x120x3,2h 13"x48"x1 1/4"h Lap. Ret.	33x80x3,2h 13"x31 1/2"x1 1/4"h Nat. Ret.	33x80x3,2h 13"x31 1/2"x1 1/4"h Lap. Ret.	33x160x3,2h 13"x63"x1 1/4"h Nat. Ret.	33x160x3,2h 13"x63"x1 1/4"h Lap. Ret.	33x120x3,2h 13"x48"x1 1/4"h Nat. Ret.	33x120x3,2h 13"x48"x1 1/4"h Lap. Ret.	33x80x3,2h 13"x31 1/2"x1 1/4"h Nat. Ret.	33x80x3,2h 13"x31 1/2"x1 1/4"h Lap. Ret.	30x160x4h 12"x63"x1 1/2"h Nat. Ret.	30x160x4h 12"x63"x1 1/2"h Lap. Ret.	30x120x4h 12"x48"x1 1/2"h Nat. Ret.	30x120x4h 12"x48"x1 1/2"h Lap. Ret.	30x80x4h 12"x31 1/2"x1 1/2"h Nat. Ret.	30x80x4h 12"x31 1/2"x1 1/2"h Lap. Ret.	30x160x4h 12"x63"x1 1/2"h Nat. Ret.	30x160x4h 12"x63"x1 1/2"h Lap. Ret.	30x120x4h 12"x48"x1 1/2"h Nat. Ret.	30x120x4h 12"x48"x1 1/2"h Lap. Ret.	30x80x4h 12"x31 1/2"x1 1/2"h Nat. Ret.	30x80x4h 12"x31 1/2"x1 1/2"h Lap. Ret.
AESTHETICA HEHEL	079251	079249	079221	079253	079259	079257	079283 SX 079267 DX	079281 SX 079265 DX	079229 SX 079225 DX	079285 SX 079269 DX	079291 SX 079275 DX	079289 SX 079273 DX	079299	079297	079233	079302	079307	079305	079331 SX 079315 DX	079329 SX 079313 DX	079241 SX 079237 DX	079333 SX 079317 DX	079339 SX 079323 DX	079337 SX 079321 DX
PREZZO PRICE	€ 272,00 PZIPCE	€ 312,00 PZIPCE	€ 176,00 PZIPCE	€ 198,00 PZIPCE	€ 100,00 PZIPCE	€ 108,00 PZIPCE	€ 304,00 PZIPCE	€ 344,00 PZIPCE	€ 212,00 PZIPCE	€ 232,00 PZIPCE	€ 136,00 PZIPCE	€ 148,00 PZIPCE	€ 178,00 PZIPCE	€ 200,00 PZIPCE	€ 126,00 PZIPCE	€ 134,00 PZIPCE	€ 68,00 PZIPCE	€ 76,00 PZIPCE	€ 240,00 PZIPCE	€ 276,00 PZIPCE	€ 178,00 PZIPCE	€ 190,00 PZIPCE	€ 116,00 PZIPCE	€ 130,00 PZIPCE
CODICE PREZZO PRICE CODE	P303	P323	P243	P265	P167	P175	P319	P339	P273	P283	P203	P215	P245	P267	P193	P201	P135	P143	P287	P305	P245	P257	P183	P197
IMBALLO cm h. PACKING cm h.	40,9	-	-	-	40,9	-	40,9	-	-	-	-	-	40,9	-	-	-	-	-	40,9	-	-	-	-	-
Tara / Tare	-	-	-	-	-	-	-	-	-	-	-	-	-	-	-	-	-	-	-	-	-	-	-	-
Icona x	1	2	2	1	1	1	1	1	1	1	1	1	1	2	2	1	1	1	1	1	1	1	1	1
m² x	-	-	-	-	-	-	-	-	-	-	-	-	-	-	-	-	-	-	-	-	-	-	-	-
Kg x	9	14	10	10	7	6	10	7	6	6	6	6	8,5	13,5	9	9	9	9	9,5	7	7	7	5	5
Icona x	-	-	-	-	-	-	-	-	-	-	-	-	-	-	-	-	-	-	-	-	-	-	-	-
m² x	-	-	-	-	-	-	-	-	-	-	-	-	-	-	-	-	-	-	-	-	-	-	-	-
Kg x	-	-	-	-	-	-	-	-	-	-	-	-	-	-	-	-	-	-	-	-	-	-	-	-



Pallet speciale con sponde
Special pallet with sides
Palette spéciale avec bords
Spezial-Palette mit Wandungen
Palet especial con bordes
Специальный поддон с боковинами

** PEZZI SPECIALI - A disposizione solo su richiesta. Tempi di consegna: 30gg.
TRIMS - Available upon request only. Delivery terms: 30 days.
PIÈCES SPECIALES - Disponible seulement sur requête. Délais de livraison: 30 jours.
FORMSTÜCKE - Verfügbar auf Anfrage. Lieferzeit: 30 Tage.
PIEZAS ESPECIALES - Disponible sólo bajo pedido. Plazo de entrega: 30 días.
СПЕЦИАЛЬНЫЕ ЭЛЕМЕНТЫ - Изготавливается только по специальной заявке. Срок поставки: 30 дней.











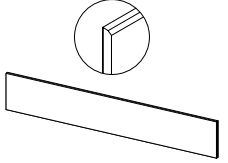
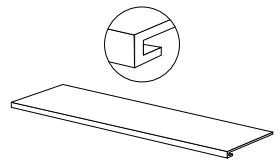
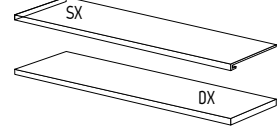
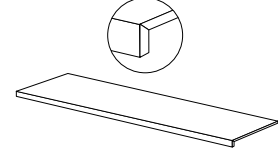
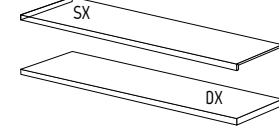

AESTHETICA HEGEL INDOOR

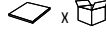
10 mm

SOLO SUPERFICIE NATURALE
ONLY NATURAL SURFACE

ANSI A - 137.1: 2012
WET DYNAMIC COEFFICIENT OF FRICTION

DCOF ≥ 0,42

	Battiscopa Skirting	Scretto Rabbeted riser	Gradino costa retta Straight nosed stair **	Gradino costa retta - Angolo SX / DX Straight-edge step - LH/RH corner **	Gradino Bordo Dritto Straight-edge step **	Gradino Bordo Dritto - Angolo SX / DX Straight-edge step - LH/RH corner **
 120x60 48"x24" Lap. Ret.	 6,5x120 2 1/2"x48" Lap. Ret.	 20x120 8"x48" Lap. Ret.	 33x120x3,2h 13"x48"x1 1/4"h Lap. Ret.	 33x120x3,2h 13"x48"x1 1/4"h Lap. Ret.	 30x120x4h 12"x48"x1 1/2"h Lap. Ret.	 30x120x4h 12"x48"x1 1/2"h Lap. Ret.
AESTHETICA HEGEL  079061	079201	079205	079261	079293 SX 079277 DX	079309	079341 SX 079325 DX
PREZZO PRICE € 58,00 m ²	€ 9,00 PZ/PCE	€ 28,00 PZ/PCE	€ 148,00 PZ/PCE	€ 176,00 PZ/PCE	€ 112,00 PZ/PCE	€ 134,00 PZ/PCE
CODICE PREZZO PRICE CODE M125	P033	P073	P215	P243	P179	P201
EPAL 80x120	Pallet 80x120	Pallet 80x120	Pallet 80x120	Pallet 80x120	Pallet 80x120	Pallet 80x120
IMBALLO cm h. PACKING cm h.	-	-	-	-	-	-
Tara / Tare	20	-	-	-	-	-
 x  2	6	1	2	1	2	1
m ² x  1,44	-	-	-	-	-	-
Kg x  33,41	11,4	12	22	11	22	11
 x  30	-	-	-	-	-	-
m ² x  43,2	-	-	-	-	-	-
Kg x  1.025	-	-	-	-	-	-

**

PEZZI SPECIALI - A disposizione solo su richiesta. Tempi di consegna: 30gg.

TRIMS - Available upon request only. Delivery terms: 30 days.

PIÈCES SPECIALES - Disponible seulement sur requête. Délais de livraison: 30 jours.

FORMSTÜCKE - Verfügbar auf Anfrage. Lieferzeit: 30 Tage.

PIEZAS ESPECIALES - Disponible sólo bajo pedido. Plazo de entrega: 30 días.

СПЕЦИАЛЬНЫЕ ЭЛЕМЕНТЫ - Изготавливается только по специальной заявке. Срок поставки: 30 дней.

AESTHETICA WILDE

LASTRE IN GRES PORCELLANATO PRESSATE A SECCO . DRY-PRESSED PORCELAIN STONEWARE SLABS .
 DALLES EN GRÈS CÉRAME PRESSÉES À SEC . TROCKENGEPRESSTE PLATTEN AUS FEINSTEINZEUG .
 PLANCHAS EN GRES PORCELÁNICO PRENSADAS EN SECO . КЕРАМОГРАНИТНЫЕ ПЛИТЫ СУХОГО ПРЕССОВАНИЯ .
 UNI EN 14411-ISO 13006 - Appendice C - Gruppo BIa - UGL

100% DESIGN
AND PRODUCTION
OF ITALY

V2
SHADE SPECTRUM
MODERATE

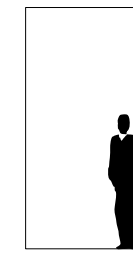

320x160 . 126"x63"
Nat. Ret.
Lap. Ret.

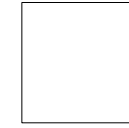

160x160 . 63"x63"
Nat. Ret.
Lap. Ret.



160x80 . 63"x31 1/2"
Nat. Ret.
Lap. Ret.



80x80 . 31 1/2"x31 1/2"
Nat. Ret.
Lap. Ret.



240x120 . 96"x48"
Nat. Ret.
Lap. Ret.

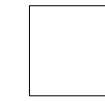

120x120 . 48"x48"
Nat. Ret.
Lap. Ret.



Mosaico
30x30 . 12"x12"
Nat. Ret.
Lap. Ret.

6 mm

modular system

modular system

INDOOR



120x60 . 48"x24"
Lap. Ret.

10 mm

SVILUPPO GRAFICO PER FORMATO
Pattern by size
Développement graphique par format
Grafischer Entwurf für Format
Desarrollo gráfico por formato
Варианты графики для каждого формата

320x160
6 mm

160x160
6 mm

160x80
6 mm

80x80
6 mm

240x120
6 mm

120x120
6 mm

120x60
10 mm

7

14

28

56

11

22

26



Wall
Collection Onice Smeraldo 320x160 (126"x63") Lap. Ret.

Floor
Aesthetica Wilde 160x80 (63"x31 1/2") Lap. Ret.

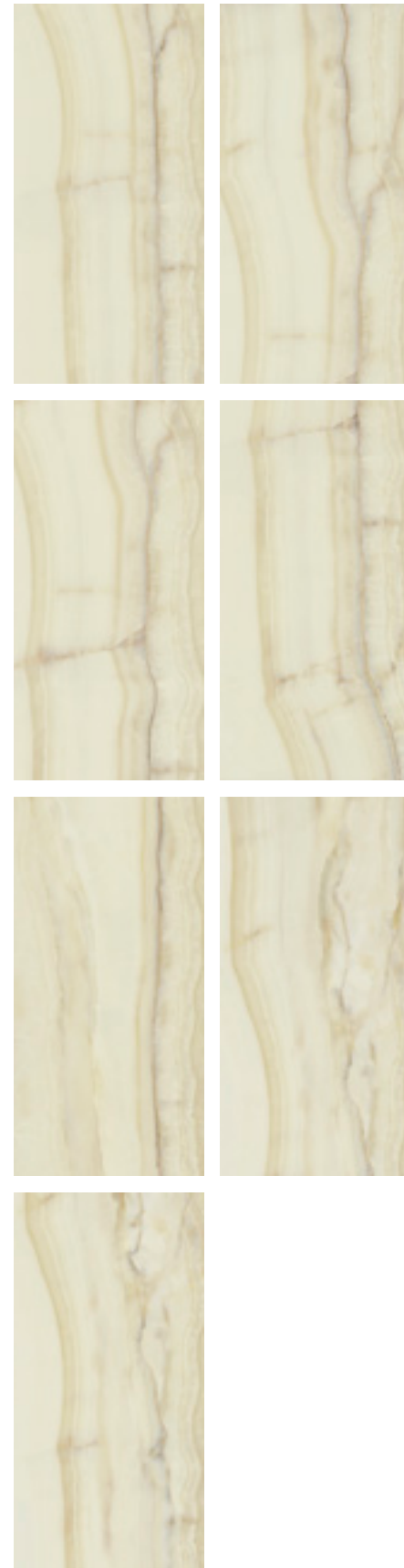
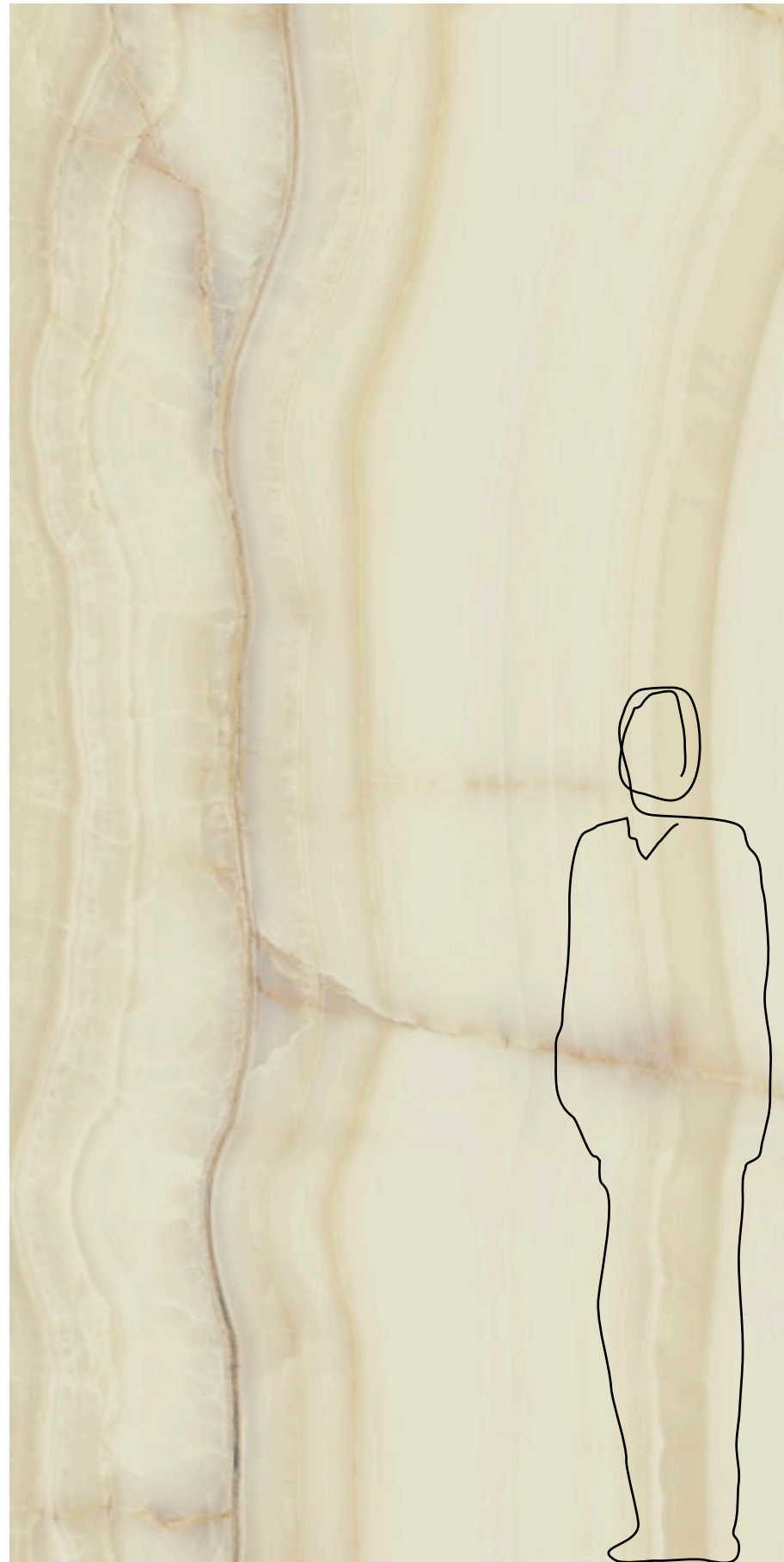

320x160
SVILUPPO GRAFICO PER FORMATO - 7 Pattern by size
 7 Développement graphique par format - 7 Grafischer Entwurf für Format
 7 Desarrollo gráfico por formato - 7 Варианты графики для каждого формата

6 mm



079006
320x160 . 126"x63"
 Nat. Ret.

079005
320x160 . 126"x63"
 Lap. Ret.



079026
160x160 . 63"x63"
 Nat. Ret.

079025
160x160 . 63"x63"
 Lap. Ret.



079046
160x80 . 63"x31 1/2"
 Nat. Ret.

079045
160x80 . 63"x31 1/2"
 Lap. Ret.



079056
80x80 . 31 1/2"x31 1/2"
 Nat. Ret.

079055
80x80 . 31 1/2"x31 1/2"
 Lap. Ret.



079016
240x120 . 96"x48"
 Nat. Ret.

079015
240x120 . 96"x48"
 Lap. Ret.



079036
120x120 . 48"x48"
 Nat. Ret.

079035
120x120 . 48"x48"
 Lap. Ret.



Mosaico
079146
30x30 . 12"x12"
 Nat. Ret.

079145
30x30 . 12"x12"
 Lap. Ret.

modular system

modular system

INDOOR











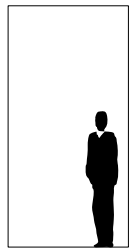
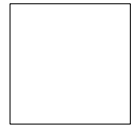
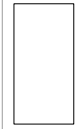

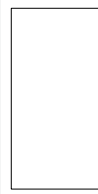



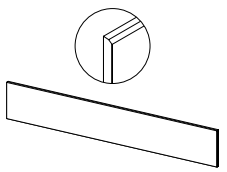















10 mm



079065
120x60 . 48"x24"
 Lap. Ret.

AESTHETICA WILDE

6 mm

		modular system								modular system				Mosaico Mosaic		Battiscopa Skirting	Scuretto Rabbeted riser					
																						
		320x160 126"x63" Nat. Ret.	320x160 126"x63" Lap. Ret.	160x160 63"x63" Nat. Ret.	160x160 63"x63" Lap. Ret.	160x80 63"x31 1/2" Nat. Ret.	160x80 63"x31 1/2" Lap. Ret.	80x80 31 1/2"x31 1/2" Nat. Ret.	80x80 31 1/2"x31 1/2" Lap. Ret.			240x120 96"x48" Nat. Ret.	240x120 96"x48" Lap. Ret.	120x120 48"x48" Nat. Ret.	120x120 48"x48" Lap. Ret.	30x30 12"x12" Nat. Ret.	30x30 12"x12" Lap. Ret.	8x80 3"x31 1/2" Lap. Ret.	20x160 8"x63" Nat. Ret.	20x160 8"x63" Lap. Ret.	20x80 8"x31 1/2" Nat. Ret.	20x80 8"x31 1/2" Lap. Ret.
AESTHETICA WILDE		079006	079005	079026	079025	079046	079045	079056	079055			079016	079015	079036	079035	079146	079145	079246	079216	079214	079220	079219
PREZZO PRICE		€ 106,00 m ²	€ 130,00 m ²	€ 94,00 m ²	€ 120,00 m ²	€ 74,00 m ²	€ 102,00 m ²	€ 62,00 m ²	€ 76,00 m ²			€ 86,00 m ²	€ 108,00 m ²	€ 74,00 m ²	€ 102,00 m ²	€ 126,00 m ²	€ 168,00 m ²	€ 8,00 PZ/PCE	€ 30,00 PZ/PCE	€ 42,00 PZ/PCE	€ 22,00 PZ/PCE	€ 30,00 PZ/PCE
CODICE PREZZO PRICE CODE		M173	M197	M161	M187	M141	M169	M129	M143			M153	M175	M141	M169	M193	M235	P029	P077	P101	P061	P077
IMBALLO cm h. PACKING cm h.							EPAL 80x120								EPAL 80x120	Pallet 80x120			Pallet 80x120			
Tara / Tare		345x175	330x75	182,6x173,6	330x75	168x97	-				264x136,6	250x75	143x123	250x75	-	-		168x97	-			
N°		37	193,5	40,4	193,5	40,9	-				40	153,5	64,7	153,5	-	-		40,9	-			
m ² x		140,00	210,00	71,80	210,00	-	-				100,00	158,00	-	158,00	-	-		-	-			
Kg x		14	44	24	88	-	-				20	44	-	88	-	-		-	-			
m ² x		5,12	5,12	2,56	2,56	-	-				2,88	2,88	-	1,44	-	-		-	-			
Kg x		74,14	74,14	37,07	37,07	-	-				41,70	41,70	-	20,85	-	-		-	-			
m ² x		-	-	-	-	2	3				-	-	2	-	-	12		1	1			
Kg x		-	-	-	-	2,56	1,92				-	-	2,88	-	-	0,77		-	-			
m ² x		-	-	-	-	37,2	27,90				-	-	41,70	-	-	11,50		5	3			
Kg x		-	-	-	-	15	40				-	-	24	-	-	-		-	-			
m ² x		71,68	225,28	61,44	225,28	38,40	76,80				57,60	126,72	69,12	126,72	-	-		-	-			
Kg x		1.178	3.472	962	3.472	648	1.141				934	1.993	1.057	1.993	-	-		-	-			

SOLO SUPERFICIE NATURALE
ONLY NATURAL SURFACE

ANSI A - 137.1: 2012
WET DYNAMIC COEFFICIENT OF FRICTION

DCOF ≥ 0,42



Cavalletto in legno
Wood A-Frame
Support en bois
Holzgestell
Caballete de madera
Деревянная подставка



Cassa
Crate
Caisse
Kiste
Caja
Ящик



Pallet speciale con sponde
Special pallet with sides
Palette spéciale avec bords
Spezial-Palette mit Wandungen
Palet especial con bordes
Специальный поддон с боковинами

AESTHETICA WILDE

6 mm

SOLO SUPERFICIE NATURALE
ONLY NATURAL SURFACE
ANSI A - 137.1: 2012
WET DYNAMIC COEFFICIENT OF FRICTION
DCOF ≥ 0,42

	Gradino costa retta Straight nosed stair **						Gradino costa retta - Angolo SX / DX Straight-edge step - LH/RH corner **						Gradino Bordo Dritto Straight-edge step **						Gradino Bordo Dritto - Angolo SX / DX Straight-edge step - LH/RH corner **					
	33x160x3,2h 13"x63"x1 1/4"h Nat. Ret.	33x160x3,2h 13"x63"x1 1/4"h Lap. Ret.	33x120x3,2h 13"x48"x1 1/4"h Nat. Ret.	33x120x3,2h 13"x48"x1 1/4"h Lap. Ret.	33x80x3,2h 13"x31 1/2"x1 1/4"h Nat. Ret.	33x80x3,2h 13"x31 1/2"x1 1/4"h Lap. Ret.	33x160x3,2h 13"x63"x1 1/4"h Nat. Ret.	33x160x3,2h 13"x63"x1 1/4"h Lap. Ret.	33x120x3,2h 13"x48"x1 1/4"h Nat. Ret.	33x120x3,2h 13"x48"x1 1/4"h Lap. Ret.	33x80x3,2h 13"x31 1/2"x1 1/4"h Nat. Ret.	33x80x3,2h 13"x31 1/2"x1 1/4"h Lap. Ret.	30x160x4h 12"x63"x1 1/2"h Nat. Ret.	30x160x4h 12"x63"x1 1/2"h Lap. Ret.	30x120x4h 12"x48"x1 1/2"h Nat. Ret.	30x120x4h 12"x48"x1 1/2"h Lap. Ret.	30x80x4h 12"x31 1/2"x1 1/2"h Nat. Ret.	30x80x4h 12"x31 1/2"x1 1/2"h Lap. Ret.	30x160x4h 12"x63"x1 1/2"h Nat. Ret.	30x160x4h 12"x63"x1 1/2"h Lap. Ret.	30x120x4h 12"x48"x1 1/2"h Nat. Ret.	30x120x4h 12"x48"x1 1/2"h Lap. Ret.	30x80x4h 12"x31 1/2"x1 1/2"h Nat. Ret.	30x80x4h 12"x31 1/2"x1 1/2"h Lap. Ret.
AESTHETICA WILDE	079252	079250	079222	079254	079260	079258	079284 SX 079268 DX	079282 SX 079266 DX	079230 SX 079226 DX	079286 SX 079270 DX	079292 SX 079276 DX	079290 SX 079274 DX	079300	079298	079234	079301	079308	079306	079332 SX 079316 DX	079330 SX 079314 DX	079242 SX 079238 DX	079334 SX 079318 DX	079340 SX 079324 DX	079338 SX 079322 DX
PREZZO PRICE	€ 272,00 PZ/PCE	€ 312,00 PZ/PCE	€ 176,00 PZ/PCE	€ 198,00 PZ/PCE	€ 100,00 PZ/PCE	€ 108,00 PZ/PCE	€ 304,00 PZ/PCE	€ 344,00 PZ/PCE	€ 212,00 PZ/PCE	€ 232,00 PZ/PCE	€ 136,00 PZ/PCE	€ 148,00 PZ/PCE	€ 178,00 PZ/PCE	€ 200,00 PZ/PCE	€ 126,00 PZ/PCE	€ 134,00 PZ/PCE	€ 68,00 PZ/PCE	€ 76,00 PZ/PCE	€ 240,00 PZ/PCE	€ 276,00 PZ/PCE	€ 178,00 PZ/PCE	€ 190,00 PZ/PCE	€ 116,00 PZ/PCE	€ 130,00 PZ/PCE
CODICE PREZZO PRICE CODE	P303	P323	P243	P265	P167	P175	P319	P339	P273	P283	P203	P215	P245	P267	P193	P201	P135	P143	P287	P305	P245	P257	P183	P197
IMBALLO cm h. PACKING cm h.	40,9	-	-	-	40,9	-	-	-	-	-	-	-	40,9	-	-	-	-	-	40,9	-	-	-	-	-
Tara / Tare	-	-	-	-	-	-	-	-	-	-	-	-	-	-	-	-	-	-	-	-	-	-	-	-
Icona x	1	2	2	1	1	1	1	1	1	1	1	1	1	2	2	2	1	1	1	1	1	1	1	1
m² x	-	-	-	-	-	-	-	-	-	-	-	-	-	-	-	-	-	-	-	-	-	-	-	-
Kg x	9	14	10	10	10	7	6	6	6	6	6	6	8,5	13,5	9	9	9	9	9,5	7	7	5	5	
Icona x	-	-	-	-	-	-	-	-	-	-	-	-	-	-	-	-	-	-	-	-	-	-	-	-
m² x	-	-	-	-	-	-	-	-	-	-	-	-	-	-	-	-	-	-	-	-	-	-	-	-
Kg x	-	-	-	-	-	-	-	-	-	-	-	-	-	-	-	-	-	-	-	-	-	-	-	-



Pallet speciale con sponde
Special pallet with sides
Palette spéciale avec bords
Spezial-Palette mit Wandungen
Palet especial con bordes
Специальный поддон с боковинами

** PEZZI SPECIALI - A disposizione solo su richiesta. Tempi di consegna: 30gg.
TRIMS - Available upon request only. Delivery terms: 30 days.
PIÈCES SPECIALES - Disponible seulement sur requête. Délais de livraison: 30 jours.
FORMSTÜCKE - Verfügbar auf Anfrage. Lieferzeit: 30 Tage.
PIEZAS ESPECIALES - Disponible sólo bajo pedido. Plazo de entrega: 30 días.
СПЕЦИАЛЬНЫЕ ЭЛЕМЕНТЫ - Изготавливается только по специальной заявке. Срок поставки: 30 дней.













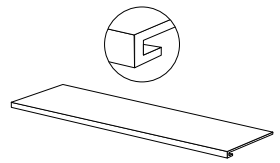
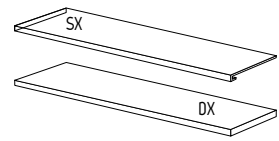
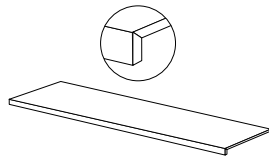
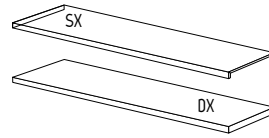

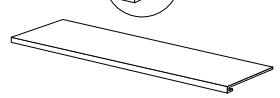
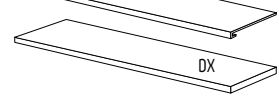
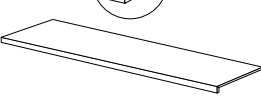

AESTHETICA WILDE INDOOR

10 mm

SOLO SUPERFICIE NATURALE
ONLY NATURAL SURFACE

ANSI A - 137.1: 2012
WET DYNAMIC COEFFICIENT OF FRICTION

DCOF ≥ 0,42

	 Battiscopa Skirting	 Scretto Rabbeted riser	 Gradino costa retta Straight nosed stair **	 Gradino costa retta - Angolo SX / DX Straight-edge step - LH/RH corner **	 Gradino Bordo Dritto Straight-edge step **	 Gradino Bordo Dritto - Angolo SX / DX Straight-edge step - LH/RH corner **	
	 120x60 48"x24" Lap. Ret.	 6,5x120 2 1/2"x48" Lap. Ret.	 20x120 8"x48" Lap. Ret.	 33x120x3,2h 13"x48"x1 1/4"h Lap. Ret.	 33x120x3,2h 13"x48"x1 1/4"h Lap. Ret.	 30x120x4h 12"x48"x1 1/2"h Lap. Ret.	 30x120x4h 12"x48"x1 1/2"h Lap. Ret.
AESTHETICA WILDE 	079065	079202	079206	079262	079294 SX 079278 DX	079310	079343 SX 079326 DX
PREZZO PRICE	€ 58,00 m ²	€ 9,00 PZ/PCE	€ 28,00 PZ/PCE	€ 148,00 PZ/PCE	€ 176,00 PZ/PCE	€ 112,00 PZ/PCE	€ 134,00 PZ/PCE
CODICE PREZZO PRICE CODE	M125	P033	P073	P215	P243	P179	P201
	EPAL 80x120	Pallet 80x120	Pallet 80x120	Pallet 80x120	Pallet 80x120	Pallet 80x120	Pallet 80x120
IMBALLO cm h. PACKING cm h.	-	-	-	-	-	-	-
Tara / Tare	20	-	-	-	-	-	-
 x 	2	6	1	2	1	2	1
m ² x 	1,44	-	-	-	-	-	-
Kg x 	33,41	11,4	12	22	11	22	11
 x 	30	-	-	-	-	-	-
m ² x 	43,2	-	-	-	-	-	-
Kg x 	1.025	-	-	-	-	-	-

**

PEZZI SPECIALI - A disposizione solo su richiesta. Tempi di consegna: 30gg.

TRIMS - Available upon request only. Delivery terms: 30 days.

PIÈCES SPECIALES - Disponible seulement sur requête. Délais de livraison: 30 jours.

FORMSTÜCKE - Verfügbar auf Anfrage. Lieferzeit: 30 Tage.

PIEZAS ESPECIALES - Disponible sólo bajo pedido. Plazo de entrega: 30 días.

СПЕЦИАЛЬНЫЕ ЭЛЕМЕНТЫ - Изготавливается только по специальной заявке. Срок поставки: 30 дней.

ARDESIA

LASTRE IN GRES PORCELLANATO PRESSATE A SECCO . DRY-PRESSED PORCELAIN STONeware SLABS .
 DALLES EN GRÈS CÉRAMÉ PRESSÉES À SEC . TROCKENGEPRESSTE PLATTEN AUS FEINSTEINZEUG .
 PLANCHAS EN GRÈS PORCELÁNICO PRENSADAS EN SECO . КЕРАМОГРАНИТНЫЕ ПЛИТЫ СУХОГО ПРЕССОВАНИЯ .
 UNI EN 14411-ISO 13006 - Appendice C - Gruppo BIa - UGL

100% DESIGN
 AND PRODUCTION
 OF ITALY

V2
 SHADE SPECTRUM
 MODERATE

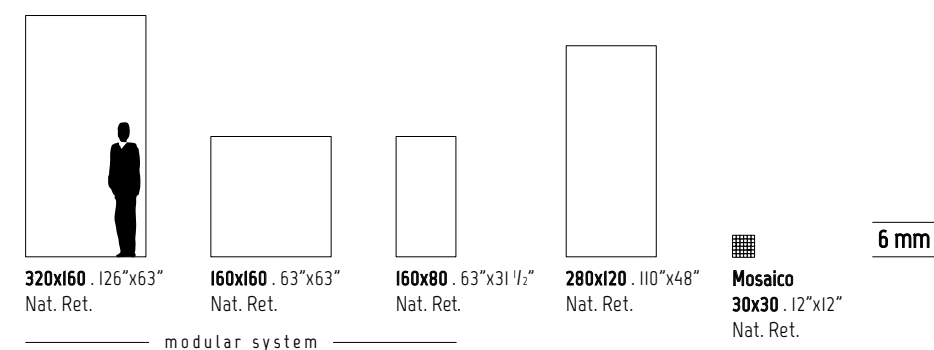

SVILUPPO GRAFICO PER FORMATO
 Pattern by size
 Développement graphique par format
 Grafischer Entwurf für Format
 Desarrollo gráfico por formato
 Варианты графики для каждого формата

	320x160 6 mm	160x160 6 mm	160x80 6 mm	280x120 6 mm
	7	14	28	11



Wall
Collection Metal: Pearl 320x160 (126"x63") Nat. Ret.

Floor
Ardesia 320x160 (126"x63") Nat. Ret.



320x160
SVILUPPO GRAFICO PER FORMATO - 7 Pattern by size
 7 Développement graphique par format - 7 Grafischer Entwurf für Format
 7 Desarrollo gráfico por formato - 7 Варианты графики для каждого формата

6 mm



141001
320x160 . 126"x63"
 Nat. Ret.



141041
160x160 . 63"x63"
 Nat. Ret.



141081
160x80 . 63"x31 1/2"
 Nat. Ret.



141021
280x120 . 110"x48"
 Nat. Ret.



Mosaico
141301
30x30 . 12"x12"
 Nat. Ret.

modular system

6 mm

modular system

ANSI A - 137.1: 2012
WET DYNAMIC COEFFICIENT OF FRICTION | DCOF ≥ 0,42

	modular system				Mosaico Mosaic	Battiscopa Skirting		Scuretto Rabbeted riser	Gradino costa retta Straight nosed stair **	Gradino costa retta - Angolo SX / DX Straight-edge step - LH/RH corner **	Gradino Bordo Dritto Straight-edge step **	Gradino Bordo Dritto - Angolo SX / DX Straight-edge step - LH/RH corner **
	320x160 126"x63" Nat. Ret.	160x160 63"x63" Nat. Ret.	160x80 63"x31 1/2" Nat. Ret.	280x120 110"x48" Nat. Ret.	30x30 12"x12" Nat. Ret.	8x80 3"x31 1/2" Nat. Ret.		20x160 8"x63" Nat. Ret.	33x160x3,2h 13"x63"x1/4"h Nat. Ret.	33x160x3,2h 13"x63"x1/4"h Nat. Ret.	30x160x4h 12"x63"x1/2"h Nat. Ret.	30x160x4h 12"x63"x1/2"h Nat. Ret.
ARDESIA	I41001	I41041	I41081	I41021	I41301	I41201		I41251	I41401	I41403 SX I41402 DX	I41407	I41409 SX I41408 DX
PREZZO PRICE	€ 106,00 m ²	€ 94,00 m ²	€ 74,00 m ²	€ 86,00 m ²	€ 126,00 m ²	€ 7,00 PZ/PCE		€ 30,00 PZ/PCE	€ 272,00 PZ/PCE	€ 304,00 PZ/PCE	€ 178,00 PZ/PCE	€ 240,00 PZ/PCE
CODICE PREZZO PRICE CODE	M173	M161	M141	M153	M193	P025		P077	P303	P319	P245	P287
IMBALLO cm h. PACKING cm h.	345x175	330x75	182,6x173,6	330x75	168x97	302x136	330x75	EPAL 80x120	Pallet 80x120	168x97	168x97	168x97
Tara / Tare	140,00	210,00	71,80	210,00	-	108,00	210,00	-	-	-	-	-
N°	14	44	24	88	-	20	44	-	-	-	-	-
m ² x	5,12	5,12	2,56	2,56	-	3,36	3,36	-	-	-	-	-
Kg x	74,14	74,14	37,07	37,07	-	48,65	48,65	-	-	-	-	-
x	-	-	-	-	2	-	-	-	12	1	1	1
m ² x	-	-	-	-	2,56	-	-	-	0,77	-	-	-
Kg x	-	-	-	-	37,2	-	-	-	11,50	5	9	10
x	-	-	-	-	15	-	-	-	-	-	-	-
m ² x	71,68	225,28	61,44	225,28	38,40	67,2	147,84	-	-	-	-	-
Kg x	1.178	3.472	962	3.472	648	1.081	2.350	-	-	-	-	-



Cavalletto in legno
Wood A-Frame
Support en bois
Holzgestell
Caballete de madera
Деревянная подставка



Cassa
Crate
Caisse
Kiste
Caja
Ящик



Pallet speciale con sponde
Special pallet with sides
Palette spéciale avec bords
Spezial-Palette mit Wandungen
Palet especial con bordes
Специальный поддон с боковинами

** PEZZI SPECIALI - A disposizione solo su richiesta. Tempi di consegna: 30gg.
TRIMS - Available upon request only. Delivery terms: 30 days.
PIÈCES SPECIALES - Disponible seulement sur requête. Délais de livraison: 30 jours.
FORMSTÜCKE - Verfügbar auf Anfrage. Lieferzeit: 30 Tage.
PIEZAS ESPECIALES - Disponible sólo bajo pedido. Plazo de entrega: 30 días.
СПЕЦИАЛЬНЫЕ ЭЛЕМЕНТЫ - Изготавливается только по специальной заявке. Срок поставки: 30 дней.

AZUL MACAUBA

LASTRE IN GRES PORCELLANATO PRESSATE A SECCO . DRY-PRESSED PORCELAIN STONWARE SLABS .
 DALLES EN GRÈS CÉRAMÉ PRESSÉES À SEC . TROCKENGEPRESSTE PLATTEN AUS FEINSTEINZEUG .
 PLANCHAS EN GRÈS PORCELÁNICO PRENSADAS EN SECO . КЕРАМОГРАНИТНЫЕ ПЛИТЫ СУХОГО ПРЕССОВАНИЯ .
 UNI EN 14411-ISO 13006 - Appendice C - Gruppo BIa - UCL

100% DESIGN
AND PRODUCTION
OF ITALY

V2
SHADE SPECTRUM
MODERATE

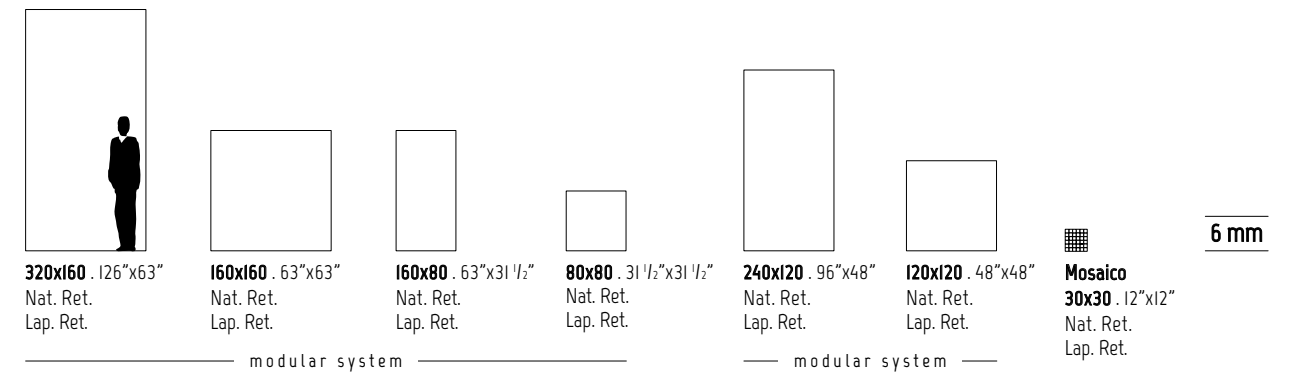

INDOOR

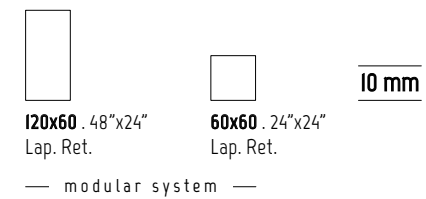

SVILUPPO GRAFICO PER FORMATO Pattern by size Développement graphique par format Grafischer Entwurf für Format Desarrollo gráfico por formato Варианты графики для каждого формата	320x160 6 mm	160x160 6 mm	160x80 6 mm	80x80 6 mm	240x120 6 mm	120x120 6 mm	120x60 10 mm	60x60 10 mm
	8	16	22	64	11	22	20	40



Wall
Azul Macauba 320x160 (126"x63") Lap. Ret.

Floor
Azul Macauba 320x160 (126"x63") Lap. Ret.

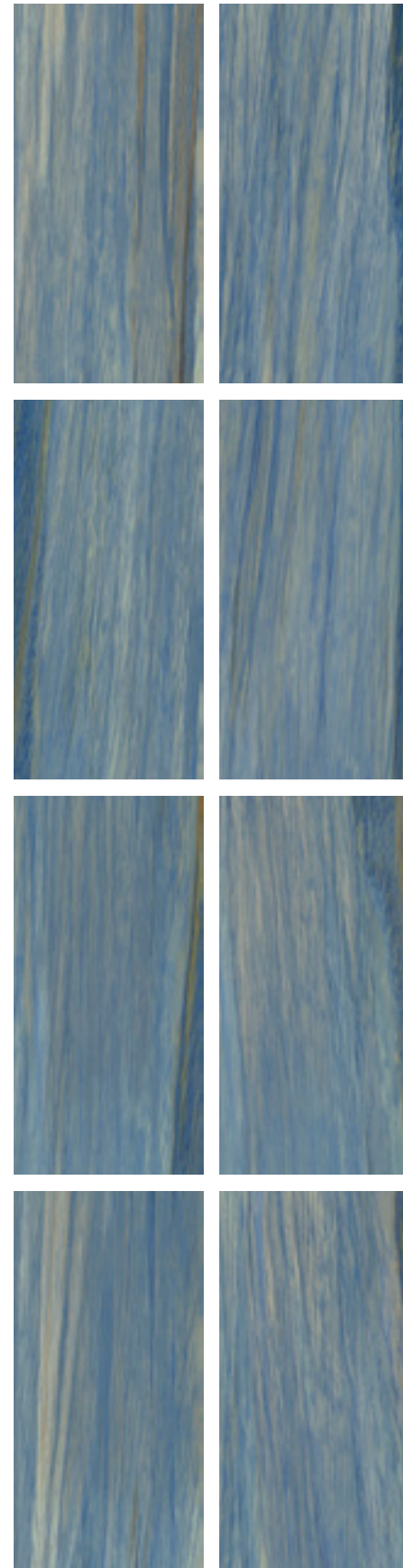
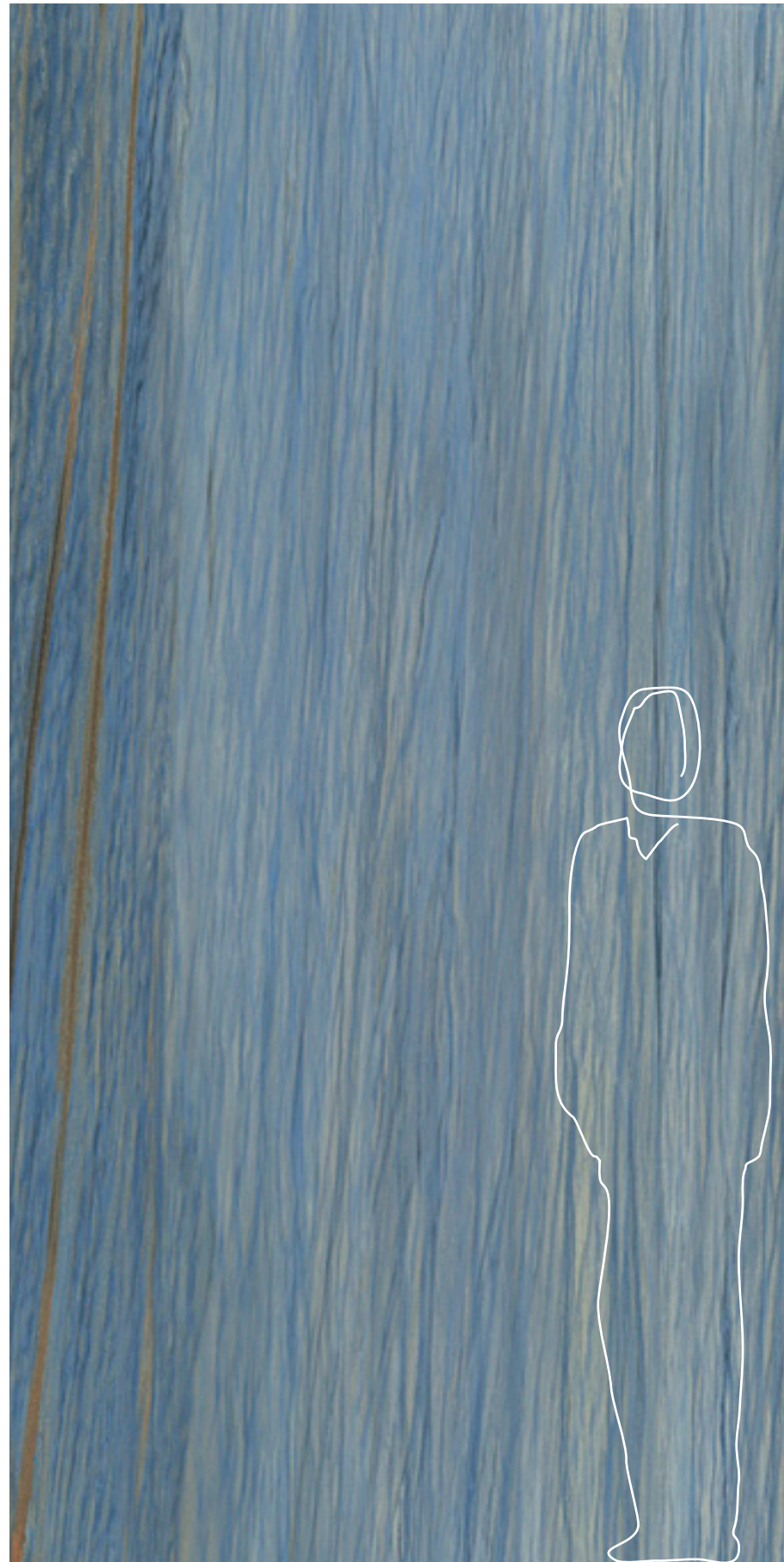

320x160
SVILUPPO GRAFICO PER FORMATO - 8 Pattern by size
 8 Développement graphique par format - 8 Grafischer Entwurf für Format
 8 Desarrollo gráfico por formato - 8 Варианты графики для каждого формата

6 mm



087002
320x160 . 126"x63"
 Nat. Ret.
087001
320x160 . 126"x63"
 Lap. Ret.

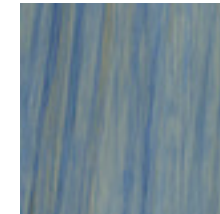

087042
160x160 . 63"x63"
 Nat. Ret.
087041
160x160 . 63"x63"
 Lap. Ret.



087082
160x80 . 63"x31 1/2"
 Nat. Ret.
087081
160x80 . 63"x31 1/2"
 Lap. Ret.

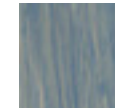

087102
80x80 . 31 1/2"x31 1/2"
 Nat. Ret.
087101
80x80 . 31 1/2"x31 1/2"
 Lap. Ret.



087022
240x120 . 96"x48"
 Nat. Ret.
087021
240x120 . 96"x48"
 Lap. Ret.



087062
120x120 . 48"x48"
 Nat. Ret.
087061
120x120 . 48"x48"
 Lap. Ret.



Mosaico
087192
30x30 . 12"x12"
 Nat. Ret.
087191
30x30 . 12"x12"
 Lap. Ret.

— modular system —

— modular system —

INDOOR

10 mm



087121
120x60 . 48"x24"
 Lap. Ret.



087141
60x60 . 24"x24"
 Lap. Ret.











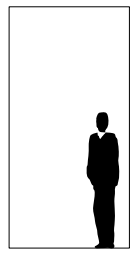

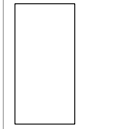

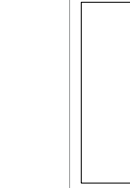

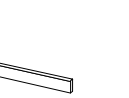
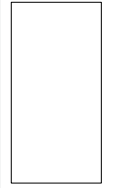

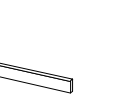



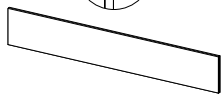
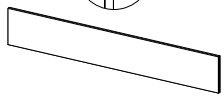
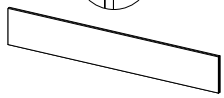
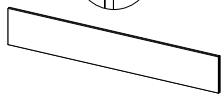









— modular system —

AZUL MACAUBA

6 mm

SOLO SUPERFICIE NATURALE
ONLY NATURAL SURFACE

ANSI A - 137.1: 2012
WET DYNAMIC COEFFICIENT OF FRICTION | DCOF ≥ 0,42

	modular system								modular system				Mosaico Mosaic	Battiscopa Skirting	Scuretto Rabbeted riser					
																				
	320x160 126"x63" Nat. Ret.	320x160 126"x63" Lap. Ret.	160x160 63"x63" Nat. Ret.	160x160 63"x63" Lap. Ret.	160x80 63"x31 1/2" Nat. Ret.	160x80 63"x31 1/2" Lap. Ret.	80x80 31 1/2"x31 1/2" Nat. Ret.	80x80 31 1/2"x31 1/2" Lap. Ret.	240x120 96"x48" Nat. Ret.	240x120 96"x48" Lap. Ret.	120x120 48"x48" Nat. Ret.	120x120 48"x48" Lap. Ret.	30x30 12"x12" Nat. Ret.	30x30 12"x12" Lap. Ret.	8x80 3"x31 1/2" Nat. Ret.	8x80 3"x31 1/2" Lap. Ret.	20x160 8"x63" Nat. Ret.	20x160 8"x63" Lap. Ret.	20x80 8"x31 1/2" Nat. Ret.	20x80 8"x31 1/2" Lap. Ret.
AZUL MACAUBA	087002	087001	087042	087041	087082	087081	087102	087101	087022	087021	087062	087061	087192	087191	087202	087201	087227	087226	087291	087290
PREZZO PRICE	€ 106,00 m ²	€ 130,00 m ²	€ 94,00 m ²	€ 120,00 m ²	€ 74,00 m ²	€ 102,00 m ²	€ 62,00 m ²	€ 76,00 m ²	€ 86,00 m ²	€ 108,00 m ²	€ 74,00 m ²	€ 102,00 m ²	€ 126,00 m ²	€ 168,00 m ²	€ 7,00 PZ/PCE	€ 8,00 PZ/PCE	€ 30,00 PZ/PCE	€ 42,00 PZ/PCE	€ 22,00 PZ/PCE	€ 30,00 PZ/PCE
CODICE PREZZO PRICE CODE	M173	M197	M161	M187	M141	M169	M129	M143	M153	M175	M141	M169	M193	M235	P025	P029	P077	P101	P061	P077
IMBALLO cm h. PACKING cm h.	 345x175	 330x75	 182,6x173,6	 330x75	 168x97	EPAL 80x120	 264x136,6	 250x75	 143x123	 250x75	EPAL 80x120	 Pallet 80x120	 Pallet 80x120	 Pallet 80x120						
Tara / Tare	140,00	210,00	71,80	210,00	-	-	100,00	158,00	-	158,00	-	-	-	-	-	-	-	-	-	-
N°	14	44	24	88	-	-	20	44	-	88	-	-	-	-	-	-	-	-	-	-
m ² x	5,12	5,12	2,56	2,56	-	-	2,88	2,88	-	1,44	-	-	-	-	-	-	-	-	-	-
Kg x	74,14	74,14	37,07	37,07	-	-	41,70	41,70	-	20,85	-	-	-	-	-	-	-	-	-	-
 x 	-	-	-	-	2	3	-	-	2	-	-	-	-	-	12	-	1	-	1	-
m ² x 	-	-	-	-	2,56	1,92	-	-	2,88	-	-	-	-	-	0,77	-	-	-	-	-
Kg x 	-	-	-	-	37,2	27,90	-	-	41,70	-	-	-	-	-	11,50	-	5	-	3	-
 x 	-	-	-	-	15	40	-	-	24	-	-	-	-	-	-	-	-	-	-	-
m ² x 	71,68	225,28	61,44	225,28	38,40	76,80	57,60	126,72	69,12	126,72	-	-	-	-	-	-	-	-	-	-
Kg x 	1.178	3.472	962	3.472	648	1.141	934	1.993	1.057	1.993	-	-	-	-	-	-	-	-	-	-



Cavalletto in legno
Wood A-Frame
Support en bois
Holzgestell
Caballete de madera
Деревянная подставка



Cassa
Crate
Caisse
Kiste
Caja
Ящик















Pallet speciale con sponde
Special pallet with sides
Palette spéciale avec bords
Spezial-Palette mit Wandungen
Palet especial con bordes
Специальный поддон с боковинами

AZUL MACAUBA

6 mm

SOLO SUPERFICIE NATURALE
ONLY NATURAL SURFACE
ANSI A - 137.1: 2012
WET DYNAMIC COEFFICIENT OF FRICTION
DCOF ≥ 0,42

	Gradino costa retta Straight nosed stair **						Gradino costa retta - Angolo SX / DX Straight-edge step - LH/RH corner **						Gradino Bordo Dritto Straight-edge step **						Gradino Bordo Dritto - Angolo SX / DX Straight-edge step - LH/RH corner **					
	33x160x3,2h 13"x63"x1 1/4"h Nat. Ret.	33x160x3,2h 13"x63"x1 1/4"h Lap. Ret.	33x120x3,2h 13"x48"x1 1/4"h Nat. Ret.	33x120x3,2h 13"x48"x1 1/4"h Lap. Ret.	33x80x3,2h 13"x31 1/2"x1 1/4"h Nat. Ret.	33x80x3,2h 13"x31 1/2"x1 1/4"h Lap. Ret.	33x160x3,2h 13"x63"x1 1/4"h Nat. Ret.	33x160x3,2h 13"x63"x1 1/4"h Lap. Ret.	33x120x3,2h 13"x48"x1 1/4"h Nat. Ret.	33x120x3,2h 13"x48"x1 1/4"h Lap. Ret.	33x80x3,2h 13"x31 1/2"x1 1/4"h Nat. Ret.	33x80x3,2h 13"x31 1/2"x1 1/4"h Lap. Ret.	30x160x4h 12"x63"x1 1/2"h Nat. Ret.	30x160x4h 12"x63"x1 1/2"h Lap. Ret.	30x120x4h 12"x48"x1 1/2"h Nat. Ret.	30x120x4h 12"x48"x1 1/2"h Lap. Ret.	30x80x4h 12"x31 1/2"x1 1/2"h Nat. Ret.	30x80x4h 12"x31 1/2"x1 1/2"h Lap. Ret.	30x160x4h 12"x63"x1 1/2"h Nat. Ret.	30x160x4h 12"x63"x1 1/2"h Lap. Ret.	30x120x4h 12"x48"x1 1/2"h Nat. Ret.	30x120x4h 12"x48"x1 1/2"h Lap. Ret.	30x80x4h 12"x31 1/2"x1 1/2"h Nat. Ret.	30x80x4h 12"x31 1/2"x1 1/2"h Lap. Ret.
AZUL MACAUBA	087303	087300	087336	087333	087363	087360	087305 SX 087304 DX	087302 SX 087301 DX	087338 SX 087337 DX	087335 SX 087334 DX	087365 SX 087364 DX	087362 SX 087361 DX	087419	087416	087442	087439	087485	087482	087421 SX 087420 DX	087418 SX 087417 DX	087444 SX 087443 DX	087441 SX 087440 DX	087487 SX 087486 DX	087484 SX 087483 DX
PREZZO PRICE	€ 272,00 PZIPCE	€ 312,00 PZIPCE	€ 176,00 PZIPCE	€ 198,00 PZIPCE	€ 100,00 PZIPCE	€ 108,00 PZIPCE	€ 304,00 PZIPCE	€ 344,00 PZIPCE	€ 212,00 PZIPCE	€ 232,00 PZIPCE	€ 136,00 PZIPCE	€ 148,00 PZIPCE	€ 178,00 PZIPCE	€ 200,00 PZIPCE	€ 126,00 PZIPCE	€ 134,00 PZIPCE	€ 68,00 PZIPCE	€ 76,00 PZIPCE	€ 240,00 PZIPCE	€ 276,00 PZIPCE	€ 178,00 PZIPCE	€ 190,00 PZIPCE	€ 116,00 PZIPCE	€ 130,00 PZIPCE
CODICE PREZZO PRICE CODE	P303	P323	P243	P265	P167	P175	P319	P339	P273	P283	P203	P215	P245	P267	P193	P201	P135	P143	P287	P305	P245	P257	P183	P197
IMBALLO cm h. PACKING cm h.	 40,9		Pallet 80x120		Pallet 80x120		 40,9		Pallet 80x120		Pallet 80x120		 40,9		Pallet 80x120		Pallet 80x120		 40,9		Pallet 80x120		Pallet 80x120	
Tara / Tare	-	-	-	-	-	-	-	-	-	-	-	-	-	-	-	-	-	-	-	-	-	-	-	-
 x 	1	2	2	1	1	1	1	1	1	1	1	1	2	2	2	1	1	1	1	1	1	1	1	1
m ² x 	-	-	-	-	-	-	-	-	-	-	-	-	-	-	-	-	-	-	-	-	-	-	-	-
Kg x 	9	14	10	10	7	6	8,5	13,5	9	9,5	7	5	-	-	-	-	-	-	-	-	-	-	-	-
 x 	-	-	-	-	-	-	-	-	-	-	-	-	-	-	-	-	-	-	-	-	-	-	-	-
m ² x 	-	-	-	-	-	-	-	-	-	-	-	-	-	-	-	-	-	-	-	-	-	-	-	-
Kg x 	-	-	-	-	-	-	-	-	-	-	-	-	-	-	-	-	-	-	-	-	-	-	-	-



Pallet speciale con sponde
Special pallet with sides
Palette spéciale avec bords
Spezial-Palette mit Wandungen
Palet especial con bordes
Специальный поддон с боковинами

** PEZZI SPECIALI - A disposizione solo su richiesta. Tempi di consegna: 30gg.
TRIMS - Available upon request only. Delivery terms: 30 days.
PIÈCES SPECIALES - Disponible seulement sur requête. Délais de livraison: 30 jours.
FORMSTÜCKE - Verfügbar auf Anfrage. Lieferzeit: 30 Tage.
PIEZAS ESPECIALES - Disponible sólo bajo pedido. Plazo de entrega: 30 días.
СПЕЦИАЛЬНЫЕ ЭЛЕМЕНТЫ - Изготавливается только по специальной заявке. Срок поставки: 30 дней.











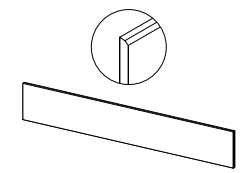
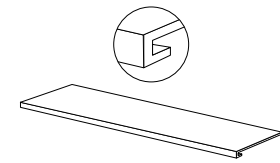
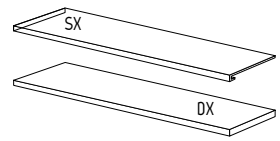
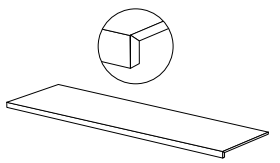
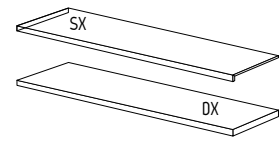

AZUL MACAUBA INDOOR

10 mm

modular system

SOLO SUPERFICIE NATURALE
ONLY NATURAL SURFACE

ANSI A - 137.1: 2012
WET DYNAMIC COEFFICIENT OF FRICTION
DCOF ≥ 0,42

	 120x60 48"x24" Lap. Ret.	 60x60 24"x24" Lap. Ret.	 6,5x120 2 1/2"x48" Lap. Ret.	 20x120 8"x48" Lap. Ret.		 33x120x3,2h 13"x48"x1 1/4" Lap. Ret.	 33x120x3,2h 13"x48"x1 1/4" Lap. Ret.	 30x120x4h 12"x48"x1 1/2" Lap. Ret.	 30x120x4h 12"x48"x1 1/2" Lap. Ret.
AZUL MACAUBA 	08712I	08714I	08721I	087233		087389	08739I SX 087390 DX	087625	087627 SX 087626 DX
PREZZO PRICE	€ 58,00 m ²	€ 48,00 m ²	€ 9,00 PZ/PCE	€ 28,00 PZ/PCE		€ 148,00 PZ/PCE	€ 176,00 PZ/PCE	€ 112,00 PZ/PCE	€ 134,00 PZ/PCE
CODICE PREZZO PRICE CODE	M125	M113	P033	P073		P215	P243	P179	P201
	EPAL 80x120	EPAL 80x120	Pallet 80x120	Pallet 80x120		Pallet 80x120	Pallet 80x120	Pallet 80x120	Pallet 80x120
IMBALLO cm h. PACKING cm h.	-	-	-	-		-	-	-	-
Tara / Tare	20	20	-	-		-	-	-	-
 x 	2	3	6	1		2	1	2	1
m ² x 	1,44	1,08	-	-		-	-	-	-
Kg x 	33,41	24,80	11,4	12		22	11	22	11
 x 	30	40	-	-		-	-	-	-
m ² x 	43,2	43,2	-	-		-	-	-	-
Kg x 	1.025	1.012	-	-		-	-	-	-

**

PEZZI SPECIALI - A disposizione solo su richiesta. Tempi di consegna: 30gg.

TRIMS - Available upon request only. Delivery terms: 30 days.

PIÈCES SPECIALES - Disponible seulement sur requête. Délais de livraison: 30 jours.

FORMSTÜCKE - Verfügbar auf Anfrage. Lieferzeit: 30 Tage.

PIEZAS ESPECIALES - Disponible sólo bajo pedido. Plazo de entrega: 30 días.

СПЕЦИАЛЬНЫЕ ЭЛЕМЕНТЫ - Изготавливается только по специальной заявке. Срок поставки: 30 дней.

BARDIGLIO CENERE

LASTRE IN GRES PORCELLANATO PRESSATE A SECCO . DRY-PRESSED PORCELAIN STONWARE SLABS .
 DALLES EN GRÈS CÉRAME PRESSÉES À SEC . TROCKENGEPRESSTE PLATTEN AUS FEINSTEINZEUG .
 PLANCHAS EN GRÈS PORCELÁNICO PRENSADAS EN SECO . КЕРАМОГРАНИТНЫЕ ПЛИТЫ СУХОГО ПРЕССОВАНИЯ .
 UNI EN 14411-ISO 13006 - Appendice C - Gruppo BIa - UGL

100% DESIGN
AND PRODUCTION
OF ITALY

V2
SHADE SPECTRUM
MODERATE



12 mm

324x163 . 127"x64"
Nat.
Lap. Nat.

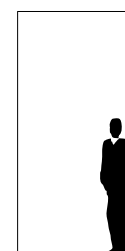

320x160 . 126"x63"
Nat. Ret.
Lap. Ret.

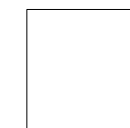

160x160 . 63"x63"
Nat. Ret.
Lap. Ret.



160x80 . 63"x31 1/2"
Nat. Ret.
Lap. Ret.



80x80 . 31 1/2"x31 1/2"
Nat. Ret.
Lap. Ret.



240x120 . 96"x48"
Nat. Ret.
Lap. Ret.

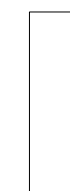

240x80 . 96"x31 1/2"
Lap. Ret.

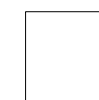

120x120 . 48"x48"
Nat. Ret.
Lap. Ret.



Mosaico
30x30 . 12"x12"
Nat. Ret.
Lap. Ret.

6 mm

modular system

modular system

INDOOR



120x60 . 48"x24"
Nat. Ret.
Lap. Ret.



60x60 . 24"x24"
Nat. Ret.
Lap. Ret.

10 mm

modular system

SVILUPPO GRAFICO PER FORMATO Pattern by size Développement graphique par format Grafischer Entwurf für Format Desarrollo gráfico por formato Варианты графики для каждого формата	320x160 6 mm	160x160 6 mm	160x80 6 mm	80x80 6 mm	240x120 6 mm	240x80 6 mm	120x120 6 mm	120x60 10 mm	60x60 10 mm	324x163 12 mm
	9	18	36	72	11	20	22	21	42	1

BARDIGLIO CENERE

Wall
Bardiglio Cenero 320x160 (126"x63") Lap. Ret.

Floor
Bardiglio Cenero 320x160 (126"x63") Lap. Ret.



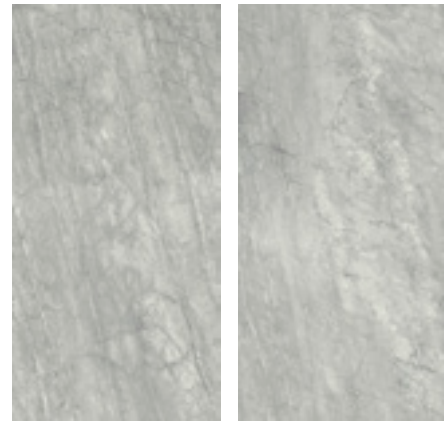
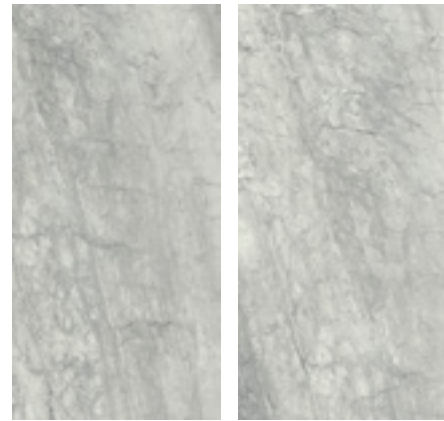
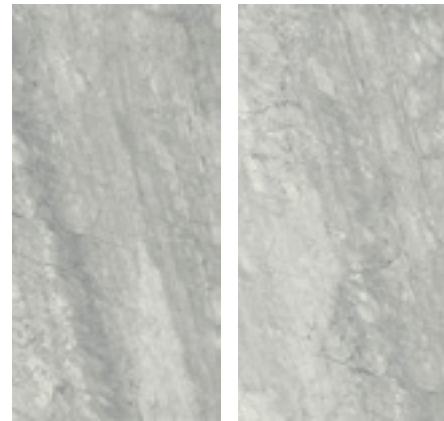
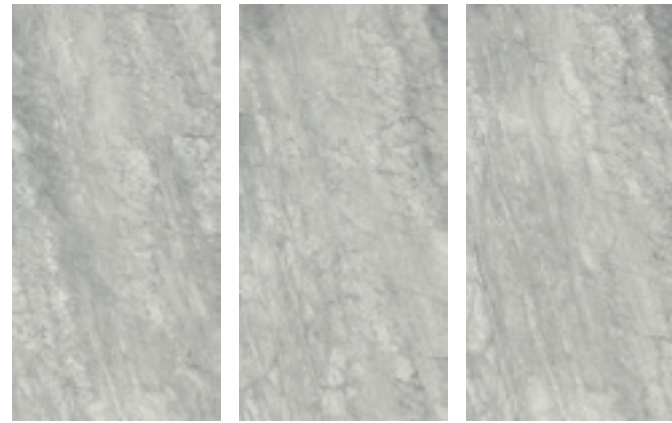

320x160
SVILUPPO GRAFICO PER FORMATO - 9 Pattern by size
9 Développement graphique par format - 9 Grafischer Entwurf für Format
9 Desarrollo gráfico por formato - 9 Варианты графики для каждого формата

12 mm



087906
324x163 . 127"x64"
Nat.
087905
324x163 . 127"x64"
Lap. Nat.

6 mm



087006
320x160 . 126"x63"
Nat. Ret.
087005
320x160 . 126"x63"
Lap. Ret.



087046
160x160 . 63"x63"
Nat. Ret.
087045
160x160 . 63"x63"
Lap. Ret.



087086
160x80 . 63"x31 1/2"
Nat. Ret.
087085
160x80 . 63"x31 1/2"
Lap. Ret.



087106
80x80 . 31 1/2"x31 1/2"
Nat. Ret.
087105
80x80 . 31 1/2"x31 1/2"
Lap. Ret.



087026
240x120 . 96"x48"
Nat. Ret.
087025
240x120 . 96"x48"
Lap. Ret.



087533
240x80 . 96"x31 1/2"
Lap. Ret.

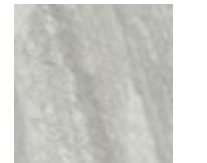

087066
120x120 . 48"x48"
Nat. Ret.
087065
120x120 . 48"x48"
Lap. Ret.



Mosaico
087196
30x30 . 12"x12"
Nat. Ret.
087195
30x30 . 12"x12"
Lap. Ret.

modular system

modular system

INDOOR

10 mm



087126
120x60 . 48"x24"
Nat. Ret.
087125
120x60 . 48"x24"
Lap. Ret.











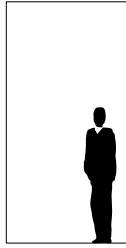
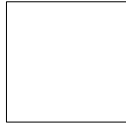











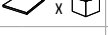

087146
60x60 . 24"x24"
Nat. Ret.
087145
60x60 . 24"x24"
Lap. Ret.

modular system

BARDIGLIO CENERE

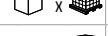
6 mm

		modular system								modular system						Mosaico Mosaic		Battiscopa Skirting		Scuretto Rabbeted riser				
																								
		320x160 126"x63" Nat. Ret.	320x160 126"x63" Lap. Ret.	160x160 63"x63" Nat. Ret.	160x160 63"x63" Lap. Ret.	160x80 63"x31 1/2" Nat. Ret.	160x80 63"x31 1/2" Lap. Ret.	80x80 31 1/2"x31 1/2" Nat. Ret.	80x80 31 1/2"x31 1/2" Lap. Ret.		240x120 96"x48" Nat. Ret.	240x120 96"x48" Lap. Ret.	240x80 96"x31 1/2" Lap. Ret.		120x120 48"x48" Nat. Ret.	120x120 48"x48" Lap. Ret.	30x30 12"x12" Nat. Ret.	30x30 12"x12" Lap. Ret.	8x80 3"x31 1/2" Nat. Ret.	8x80 3"x31 1/2" Lap. Ret.	20x160 8"x63" Nat. Ret.	20x160 8"x63" Lap. Ret.	20x80 8"x31 1/2" Nat. Ret.	20x80 8"x31 1/2" Lap. Ret.
BARDIGLIO CENERE		087006	087005	087046	087045	087086	087085	087106	087105		087026	087025	087533		087066	087065	087196	087195	087206	087205	087229	087228	087293	087292
PREZZO PRICE	€	106,00 m ²	130,00 m ²	94,00 m ²	120,00 m ²	74,00 m ²	102,00 m ²	62,00 m ²	76,00 m ²		86,00 m ²	108,00 m ²	108,00 m ²		74,00 m ²	102,00 m ²	126,00 m ²	168,00 m ²	7,00 PZ/PCE	8,00 PZ/PCE	30,00 PZ/PCE	42,00 PZ/PCE	22,00 PZ/PCE	30,00 PZ/PCE
CODICE PREZZO PRICE CODE		M173	M197	M161	M187	M141	M169	M129	M143		M153	M175	M175		M141	M169	M193	M235	P025	P029	P077	P101	P061	P077
IMBALLO cm h. PACKING cm h.		37	193,5	40,4	193,5	40,9					40	153,5	47	153,5	64,7	153,5	-	-	-	-	40,9	-	-	-
Tara / Tare		140,00	210,00	71,80	210,00	-		20			100,00	158,00	78,00	158,00	-	158,00	-	-	-	-	-	-	-	-
N°		14	44	24	88	-		-			20	44	30	44	-	88	-	-	-	-	-	-	-	-
m ² x		5,12	5,12	2,56	2,56	-		-			2,88	2,88	1,92	1,92	-	1,44	-	-	-	-	-	-	-	-
Kg x		74,14	74,14	37,07	37,07	-		-			41,70	41,70	27,80	27,80	-	20,85	-	-	-	-	-	-	-	-
 x 		-	-	-	-	2		3			-	-	-	-	2	-	-	-	12		1		1	
m ² x		-	-	-	-	2,56		1,92			-	-	-	-	2,88	-	-	-	0,77		-		-	
Kg x		-	-	-	-	37,2		27,90			-	-	-	-	41,70	-	-	-	11,50		5		3	
 x 		-	-	-	-	15		40			-	-	-	-	24	-	-	-	-		-		-	
m ² x		71,68	225,28	61,44	225,28	38,40		76,80			57,60	126,72	57,6	84,48	69,12	126,72	-	-	-	-	-	-	-	-
Kg x		1.178	3.472	962	3.472	648		1.141			934	1.993	912	1.381	1.057	1.993	-	-	-	-	-	-	-	-

SOLO SUPERFICIE NATURALE
ONLY NATURAL SURFACE

ANSI A - 137.1: 2012
WET DYNAMIC COEFFICIENT OF FRICTION

DCOF ≥ 0,42



Cavalletto in legno
Wood A-Frame
Support en bois
Holzgestell
Caballete de madera
Деревянная подставка



Cassa
Crate
Caisse
Kiste
Caja
Ящик



Pallet speciale con sponde
Special pallet with sides
Palette spéciale avec bords
Spezial-Palette mit Wandungen
Palet especial con bordes
Специальный поддон с боковинами

BARDIGLIO CENERE

6 mm

SOLO SUPERFICIE NATURALE
ONLY NATURAL SURFACE
ANSI A - 137.1: 2012
WET DYNAMIC COEFFICIENT OF FRICTION
DCOF ≥ 0,42

	Gradino costa retta Straight nosed stair **						Gradino costa retta - Angolo SX / DX Straight-edge step - LH/RH corner **						Gradino Bordo Dritto Straight-edge step **						Gradino Bordo Dritto - Angolo SX / DX Straight-edge step - LH/RH corner **					
	33x160x3,2h 13"x63"x1 1/4"h Nat. Ret.	33x160x3,2h 13"x63"x1 1/4"h Lap. Ret.	33x120x3,2h 13"x48"x1 1/4"h Nat. Ret.	33x120x3,2h 13"x48"x1 1/4"h Lap. Ret.	33x80x3,2h 13"x31 1/2"x1 1/4"h Nat. Ret.	33x80x3,2h 13"x31 1/2"x1 1/4"h Lap. Ret.	33x160x3,2h 13"x63"x1 1/4"h Nat. Ret.	33x160x3,2h 13"x63"x1 1/4"h Lap. Ret.	33x120x3,2h 13"x48"x1 1/4"h Nat. Ret.	33x120x3,2h 13"x48"x1 1/4"h Lap. Ret.	33x80x3,2h 13"x31 1/2"x1 1/4"h Nat. Ret.	33x80x3,2h 13"x31 1/2"x1 1/4"h Lap. Ret.	30x160x4h 12"x63"x1 1/2"h Nat. Ret.	30x160x4h 12"x63"x1 1/2"h Lap. Ret.	30x120x4h 12"x48"x1 1/2"h Nat. Ret.	30x120x4h 12"x48"x1 1/2"h Lap. Ret.	30x80x4h 12"x31 1/2"x1 1/2"h Nat. Ret.	30x80x4h 12"x31 1/2"x1 1/2"h Lap. Ret.	30x160x4h 12"x63"x1 1/2"h Nat. Ret.	30x160x4h 12"x63"x1 1/2"h Lap. Ret.	30x120x4h 12"x48"x1 1/2"h Nat. Ret.	30x120x4h 12"x48"x1 1/2"h Lap. Ret.	30x80x4h 12"x31 1/2"x1 1/2"h Nat. Ret.	30x80x4h 12"x31 1/2"x1 1/2"h Lap. Ret.
BARDIGLIO CENERE	087309	087306	087342	087339	087369	087366	087311 SX 087310 DX	087308 SX 087307 DX	087344 SX 087343 DX	087341 SX 087340 DX	087371 SX 087370 DX	087368 SX 087367 DX	087651	087422	087448	087445	087491	087488	087655 SX 087653 DX	087654 SX 087652 DX	087450 SX 087449 DX	087447 SX 087446 DX	087493 SX 087492 DX	087490 SX 087489 DX
PREZZO PRICE	€ 272,00 PZ/PCE	€ 312,00 PZ/PCE	€ 176,00 PZ/PCE	€ 198,00 PZ/PCE	€ 100,00 PZ/PCE	€ 108,00 PZ/PCE	€ 304,00 PZ/PCE	€ 344,00 PZ/PCE	€ 212,00 PZ/PCE	€ 232,00 PZ/PCE	€ 136,00 PZ/PCE	€ 148,00 PZ/PCE	€ 178,00 PZ/PCE	€ 200,00 PZ/PCE	€ 126,00 PZ/PCE	€ 134,00 PZ/PCE	€ 68,00 PZ/PCE	€ 76,00 PZ/PCE	€ 240,00 PZ/PCE	€ 276,00 PZ/PCE	€ 178,00 PZ/PCE	€ 190,00 PZ/PCE	€ 116,00 PZ/PCE	€ 130,00 PZ/PCE
CODICE PREZZO PRICE CODE	P303	P323	P243	P265	P167	P175	P319	P339	P273	P283	P203	P215	P245	P267	P193	P201	P135	P143	P287	P305	P245	P257	P183	P197
IMBALLO cm h. PACKING cm h.	168x97		Pallet 80x120		Pallet 80x120		168x97		Pallet 80x120		Pallet 80x120		168x97		Pallet 80x120		Pallet 80x120		168x97		Pallet 80x120		Pallet 80x120	
Tara / Tare	40,9	-	-	-	-	-	40,9	-	-	-	-	-	40,9	-	-	-	-	-	40,9	-	-	-	-	-
	-	-	-	-	-	-	-	-	-	-	-	-	-	-	-	-	-	-	-	-	-	-	-	-
	1	2	2	1	1	1	1	1	1	1	1	1	2	2	2	1	1	1	1	1	1	1	1	1
	-	-	-	-	-	-	-	-	-	-	-	-	-	-	-	-	-	-	-	-	-	-	-	-
	9	14	10	10	10	7	10	7	6	6	6	8,5	13,5	9	9,5	9,5	7	5	7	7	7	5	5	
	-	-	-	-	-	-	-	-	-	-	-	-	-	-	-	-	-	-	-	-	-	-	-	-
	-	-	-	-	-	-	-	-	-	-	-	-	-	-	-	-	-	-	-	-	-	-	-	-















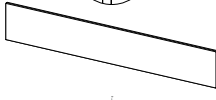
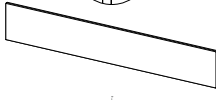
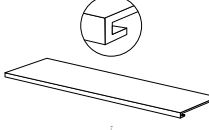
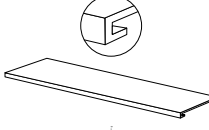
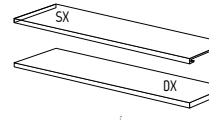
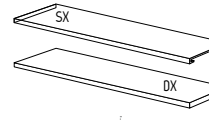
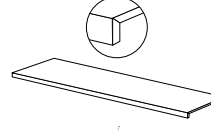
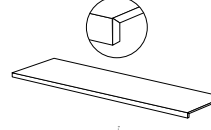
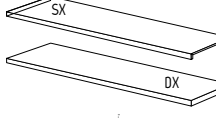
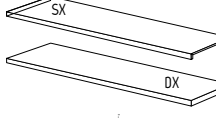

Pallet speciale con sponde
Special pallet with sides
Palette spéciale avec bords
Spezial-Palette mit Wandungen
Palet especial con bordes
Специальный поддон с боковинами

** PEZZI SPECIALI - A disposizione solo su richiesta. Tempi di consegna: 30gg.
TRIMS - Available upon request only. Delivery terms: 30 days.
PIÈCES SPECIALES - Disponible seulement sur requête. Délais de livraison: 30 jours.
FORMSTÜCKE - Verfügbar auf Anfrage. Lieferzeit: 30 Tage.
PIEZAS ESPECIALES - Disponible sólo bajo pedido. Plazo de entrega: 30 días.
СПЕЦИАЛЬНЫЕ ЭЛЕМЕНТЫ - Изготавливается только по специальной заявке. Срок поставки: 30 дней.

BARDIGLIO CENERE INDOOR

10 mm











modular system

	modular system				Battiscopa Skirting		Scuretto Rabbeted riser		Gradino costa retta Straight nosed stair **		Gradino costa retta - Angolo SX / DX Straight-edge step - LH/RH corner **		Gradino Bordo Dritto Straight-edge step **		Gradino Bordo Dritto - Angolo SX / DX Straight-edge step - LH/RH corner **	
																
	120x60 48"x24" Nat. Ret.	120x60 48"x24" Lap. Ret.	60x60 24"x24" Nat. Ret.	60x60 24"x24" Lap. Ret.	6,5x120 2 1/2"x48" Nat. Ret.	6,5x120 2 1/2"x48" Lap. Ret.	20x120 8"x48" Nat. Ret.	20x120 8"x48" Lap. Ret.	33x120x3,2h 13"x48"x1 1/4" Nat. Ret.	33x120x3,2h 13"x48"x1 1/4" Lap. Ret.	33x120x3,2h 13"x48"x1 1/4" Nat. Ret.	33x120x3,2h 13"x48"x1 1/4" Lap. Ret.	30x120x4h 12"x48"x1 1/2" Nat. Ret.	30x120x4h 12"x48"x1 1/2" Lap. Ret.	30x120x4h 12"x48"x1 1/2" Nat. Ret.	30x120x4h 12"x48"x1 1/2" Lap. Ret.
BARDIGLIO CENERE	087126	087125	087146	087145	087216	087215	087283	087282	087395	087392	087397 SX 087396 DX	087394 SX 087393 DX	087631	087628	087633 SX 087632 DX	087630 SX 087629 DX
PREZZO PRICE	€ 46,00 m ²	€ 58,00 m ²	€ 36,00 m ²	€ 48,00 m ²	€ 8,00 PZ/PCE	€ 9,00 PZ/PCE	€ 26,00 PZ/PCE	€ 28,00 PZ/PCE	€ 140,00 PZ/PCE	€ 148,00 PZ/PCE	€ 164,00 PZ/PCE	€ 176,00 PZ/PCE	€ 106,00 PZ/PCE	€ 112,00 PZ/PCE	€ 134,00 PZ/PCE	€ 134,00 PZ/PCE
CODICE PREZZO PRICE CODE	M109	M125	M089	M113	P029	P033	P069	P073	P207	P215	P231	P243	P173	P179	P201	P201
	EPAL 80x120		EPAL 80x120		Pallet 80x120		Pallet 80x120		Pallet 80x120		Pallet 80x120		Pallet 80x120		Pallet 80x120	
IMBALLO cm h. PACKING cm h.	-	-	-	-	-	-	-	-	-	-	-	-	-	-	-	-
Tara / Tare	20	20	-	-	-	-	-	-	-	-	-	-	-	-	-	-
 x 	2	3	6	1	2	1	2	1	2	1	2	1	2	1	1	1
m ² x 	1,44	1,08	-	-	-	-	-	-	-	-	-	-	-	-	-	-
Kg x 	33,41	24,80	11,4	12	22	11	22	11	22	11	22	11	22	11	11	11
 x 	30	40	-	-	-	-	-	-	-	-	-	-	-	-	-	-
m ² x 	43,2	43,2	-	-	-	-	-	-	-	-	-	-	-	-	-	-
Kg x 	1.025	1.012	-	-	-	-	-	-	-	-	-	-	-	-	-	-

SOLO SUPERFICIE NATURALE
ONLY NATURAL SURFACE

ANSI A - 137.1: 2012
WET DYNAMIC COEFFICIENT OF FRICTION | DCOF ≥ 0,42

12 mm

	12 mm		
			
	324x163 127"x64" Nat.	324x163 127"x64" Lap. Nat.	
BARDIGLIO CENERE	087906	087905	
PREZZO PRICE	€ 154,00 m ²	€ 180,00 m ²	
CODICE PREZZO PRICE CODE	M221	M247	
			
	345x175	330x75	330x75
IMBALLO cm h. PACKING cm h.	37	193,5	193,5
Tara / Tare	150,00	229,00	259,00
N° 	10	22	22
m ² x 	5,28	5,28	5,28
Kg x 	152,47	152,47	152,47
m ² x 	52,80	116,16	116,16
Kg x 	1.674	3.583	3.613

**

PEZZI SPECIALI - A disposizione solo su richiesta. Tempi di consegna: 30gg.

TRIMS - Available upon request only. Delivery terms: 30 days.

PIÈCES SPECIALES - Disponible seulement sur requête. Délais de livraison: 30 jours.

FORMSTÜCKE - Verfügbar auf Anfrage. Lieferzeit: 30 Tage.

PIEZAS ESPECIALES - Disponible sólo bajo pedido. Plazo de entrega: 30 días.

СПЕЦИАЛНЫЕ ЭЛЕМЕНТЫ - Изготавливается только по специальной заявке. Срок поставки: 30 дней.



Cassa
Crate
Caisse
Kiste
Caja
Ящик



Cavalletto in legno
Wood A-Frame
Support en bois
Holzgestell
Caballette de madera
Деревянная подставка



Cavalletto in ferro
Iron A-Frame
Support en fer
Metallgestell
Caballette de hierro
Металлическая подставка

BRONZE AMANI

LASTRE IN GRES PORCELLANATO PRESSATE A SECCO . DRY-PRESSED PORCELAIN STONWARE SLABS .
 DALLES EN GRÈS CÉRAMÉ PRESSÉES À SEC . TROCKENGEPRESSTE PLATTEN AUS FEINSTEINZEUG .
 PLANCHAS EN GRES PORCELÁNICO PRENSADAS EN SECO . КЕРАМОГРАНИТНЫЕ ПЛИТЫ СУХОГО ПРЕССОВАНИЯ .
 UNI EN 14411-ISO 13006 - Appendice C - Gruppo BIa - UGL

100% DESIGN
AND PRODUCTION
OF ITALY

V2
SHADE SPECTRUM
MODERATE

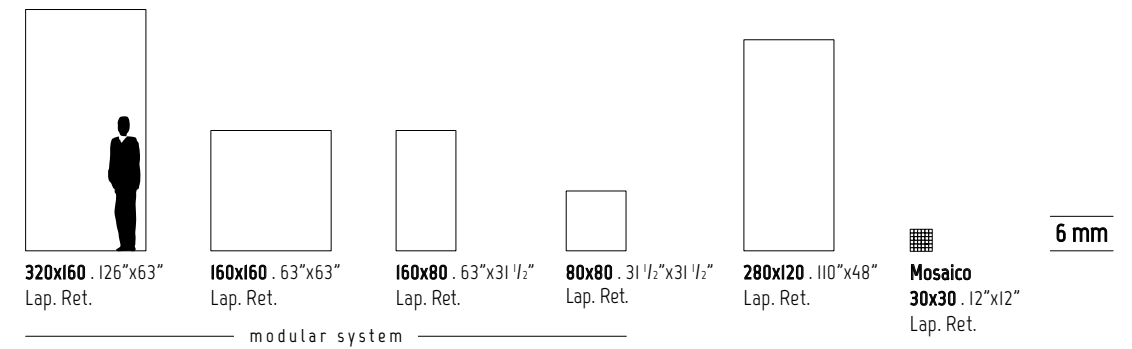

SVILUPPO GRAFICO PER FORMATO
 Pattern by size
 Développement graphique par format
 Grafischer Entwurf für Format
 Desarrollo gráfico por formato
 Варианты графики для каждого формата

320x160 6 mm	160x160 6 mm	160x80 6 mm	80x80 6 mm	280x120 6 mm
7	14	28	56	11



Wall
Collection Taj Mahal 320x160 (126"x63") Lap. Ret.

Floor
Bronze Amani 320x160 (126"x63") Lap. Ret.

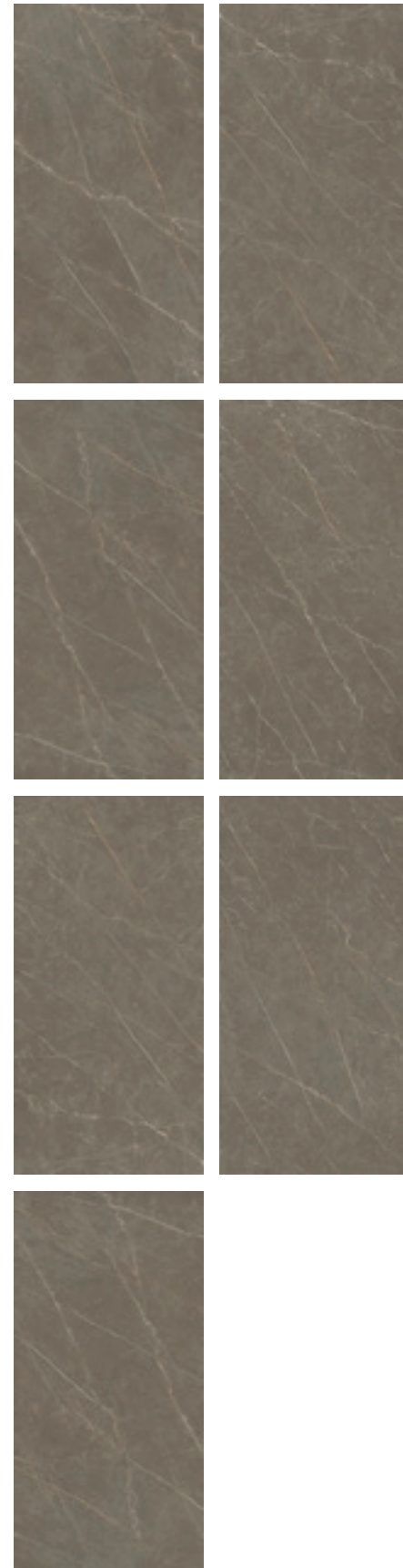
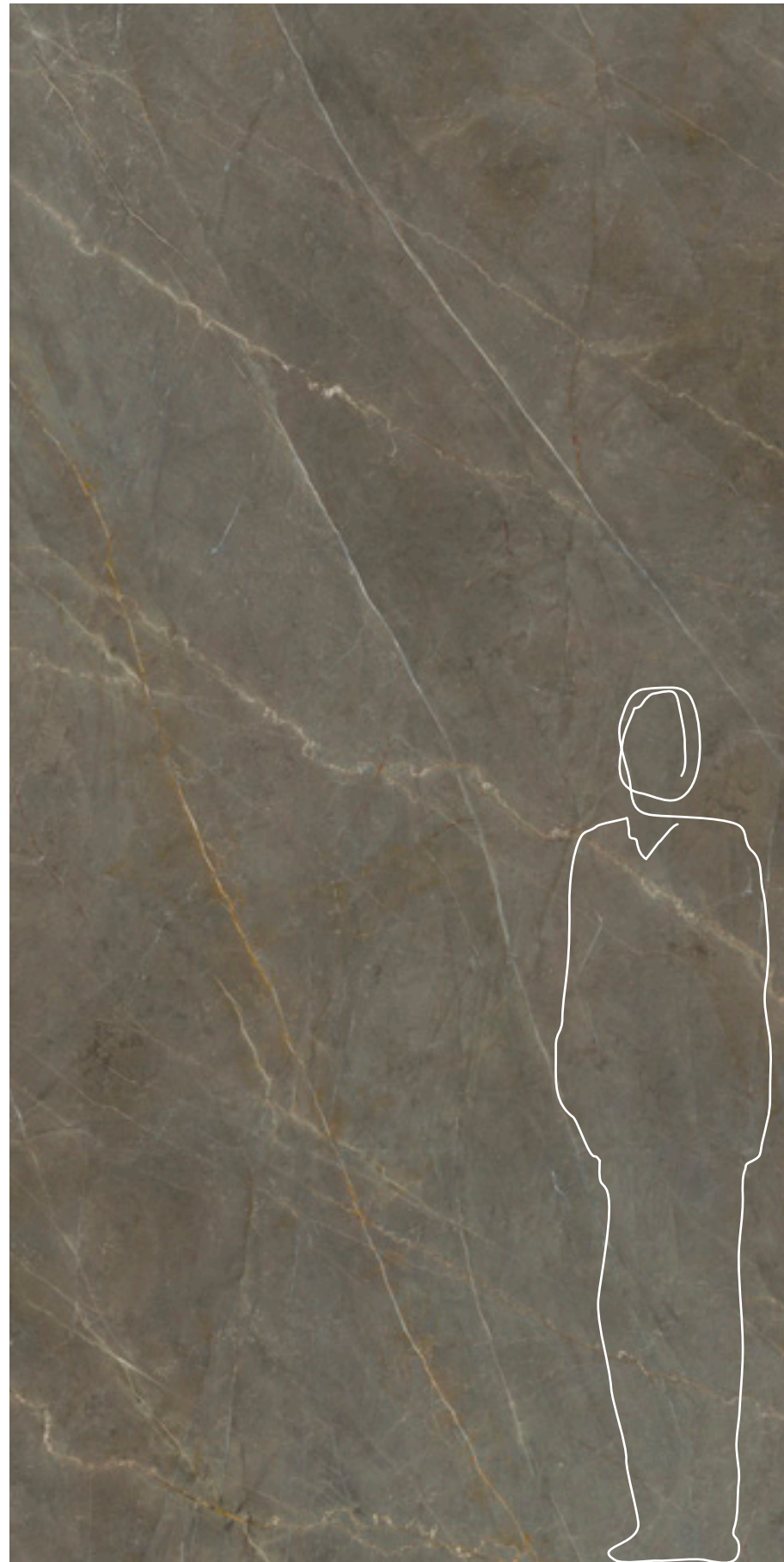

320x160
SVILUPPO GRAFICO PER FORMATO - 7 Pattern by size
 7 Développement graphique par format - 7 Grafischer Entwurf für Format
 7 Desarrollo gráfico por formato - 7 Варианты графики для каждого формата

6 mm

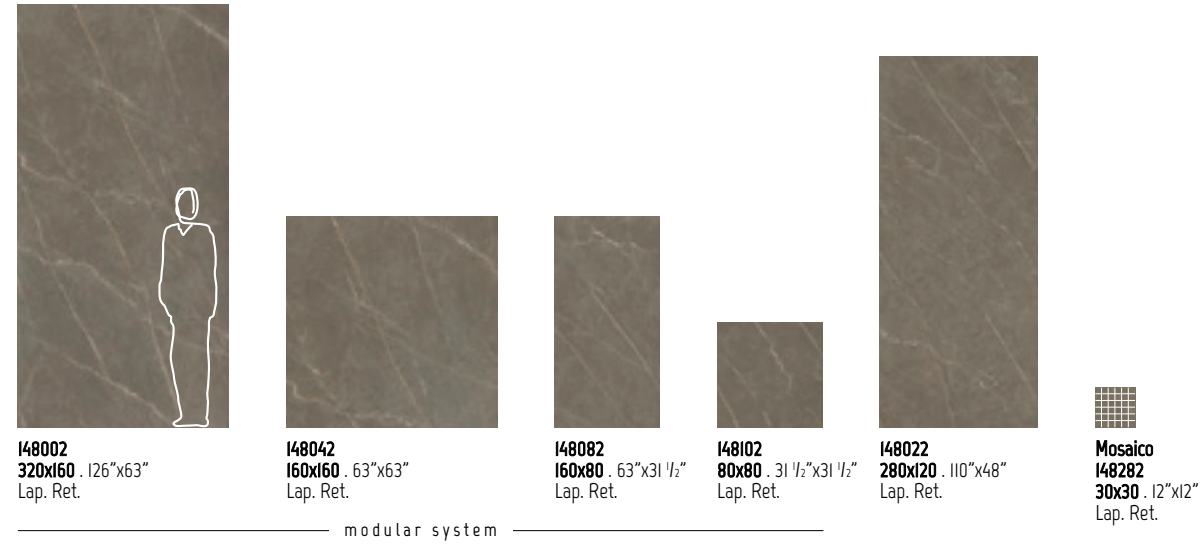

LA SERIE BRONZE AMANI SI COMPLETA CON ALTRI FORMATI DEL CATALOGO LA FABBRICA MARMO E PIETRA: SERIE MARM

The Bronze Amani series is completed with the other sizes which can be seen in the La Fabbrica Marble & Stone catalogue: Marmi series.
 La série Bronze Amani est complétée par d'autres formats du catalogue La Fabbrica Marbres et Pierres : série Marmi.
 Die Serie Bronze Amani wird durch andere Formate des Katalogs La Fabbrica Marmore und Steine: Serie Marmi.
 La serie Bronze Amani se completa con otros formatos del catálogo La Fabbrica Mármoles y Piedras: serie Marmi.
 Серия Bronze Amani дополняется другими форматами из каталога La Fabbrica Мрамор и Камень: серия Marmi.

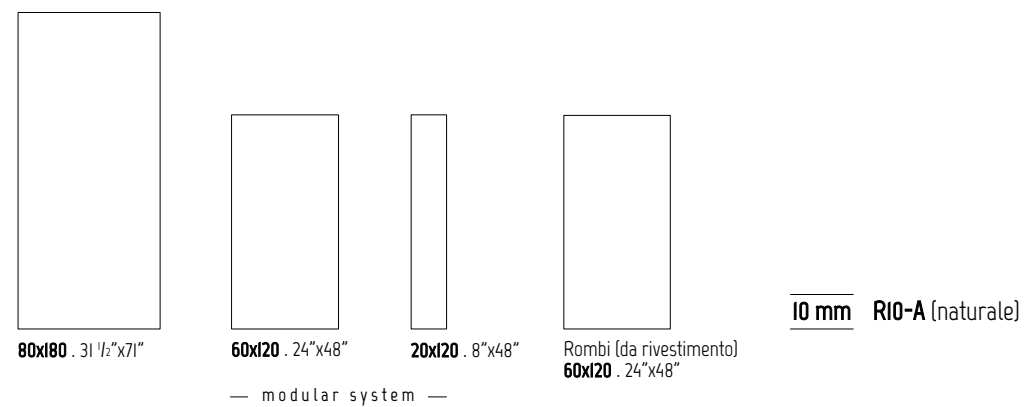

I VETTORIALI DEI FORMATI NON SONO IN SCALA CON QUELLI DI AVA

The vector images of the sizes shown here are not in scale with the AVA images.
 Les vecteurs des formats présentés ici ne sont pas à l'échelle avec ceux d'AVA.
 Die Vektorbilder der hier angegebenen Formate sind nicht maßstabsgetreu zu denen von AVA.
 Los vectoriales de los formatos aquí indicados no están a escala con aquellos de AVA.
 Масштаб векторных изображений указанных здесь форматов не совпадает с масштабом векторных изображений AVA.

BRONZE AMANI

6 mm

modular system

SOLO SUPERFICIE NATURALE
ONLY NATURAL SURFACE

ANSI A - 137.1: 2012
WET DYNAMIC COEFFICIENT OF FRICTION
DCOF ≥ 0,42

	modular system				Mosaico Mosaic	Battiscopa Skirting	Scuretto Rabbeted riser	Gradino costa retta Straight nosed stair **	Gradino costa retta - Angolo SX / DX Straight-edge step - LH/RH corner **	Gradino Bordo Dritto Straight-edge step **	Gradino Bordo Dritto - Angolo SX / DX Straight-edge step - LH/RH corner **							
	320x160 126"x63" Lap. Ret.	160x160 63"x63" Lap. Ret.	160x80 63"x31 1/2" Lap. Ret.	80x80 31 1/2"x31 1/2" Lap. Ret.	280x120 110"x48" Lap. Ret.	30x30 12"x12" Lap. Ret.	8x80 3"x31 1/2" Lap. Ret.	20x160 8"x63" Lap. Ret.	20x80 8"x31 1/2" Lap. Ret.	33x160x3,2h 13"x63"x1 1/4" Lap. Ret.	33x80x3,2h 13"x31 1/2"x1 1/4" Lap. Ret.	33x160x3,2h 13"x63"x1 1/4" Lap. Ret.	33x80x3,2h 13"x31 1/2"x1 1/4" Lap. Ret.	30x160x4h 12"x63"x1 1/2" Lap. Ret.	30x80x4h 12"x31 1/2"x1 1/2" Lap. Ret.	30x160x4h 12"x63"x1 1/2" Lap. Ret.	30x80x4h 12"x31 1/2"x1 1/2" Lap. Ret.	
BRONZE AMANI	148002	148042	148082	148102	148022	148282	148202	148212	148222	148234	148244	148236 SX 148235 DX	148246 SX 148245 DX	148254	148264	148256 SX 148255 DX	148266 SX 148265 DX	
PREZZO PRICE	€ 130,00 m ²	€ 120,00 m ²	€ 102,00 m ²	€ 72,00 m ²	€ 108,00 m ²	€ 168,00 m ²	€ 8,00 PZ/PCE	€ 42,00 PZ/PCE	€ 30,00 PZ/PCE	€ 312,00 PZ/PCE	€ 108,00 PZ/PCE	€ 344,00 PZ/PCE	€ 148,00 PZ/PCE	€ 200,00 PZ/PCE	€ 76,00 PZ/PCE	€ 276,00 PZ/PCE	€ 130,00 PZ/PCE	
CODICE PREZZO PRICE CODE	M197	M187	M169	M139	M175	M235	P029	P101	P077	P323	P175	P339	P215	P267	P143	P305	P197	
						EPAL 80x120			EPAL 80x120	Pallet 80x120		Pallet 80x120		Pallet 80x120		Pallet 80x120		Pallet 80x120
IMBALLO cm h. PACKING cm h.	37	193,5	40,4	193,5	40,9	-	33,8	193,5	-	-	40,9	-	40,9	-	40,9	-	40,9	-
Tara / Tare	140,00	210,00	71,80	210,00	-	20	108,00	210,00	-	-	-	-	-	-	-	-	-	-
N°	14	44	24	88	-	-	20	44	-	-	-	-	-	-	-	-	-	-
m ² x	5,12	5,12	2,56	2,56	-	-	3,36	3,36	-	-	-	-	-	-	-	-	-	-
Kg x	74,14	74,14	37,07	37,07	-	-	48,65	48,65	-	-	-	-	-	-	-	-	-	-
x	-	-	-	-	2	3	-	-	-	12	1	1	1	2	1	1	1	1
m ² x	-	-	-	-	2,56	1,92	-	-	-	0,77	-	-	-	-	-	-	-	-
Kg x	-	-	-	-	37,2	27,90	-	-	-	11,50	5	3	9	10	10	6	8,5	9
x	-	-	-	-	15	40	-	-	-	-	-	-	-	-	-	-	-	-
m ² x	71,68	225,28	61,44	225,28	38,40	76,80	67,2	147,84	-	-	-	-	-	-	-	-	-	-
Kg x	1.178	3.472	962	3.472	648	1.141	1.081	2.350	-	-	-	-	-	-	-	-	-	-



Cavalletto in legno
Wood A-Frame
Support en bois
Holzgestell
Caballete de madera
Деревянная подставка



Cassa
Crate
Caisse
Kiste
Caja
Ящик



Pallet speciale con sponde
Special pallet with sides
Palette spéciale avec bords
Spezial-Palette mit Wandungen
Palet especial con bordes
Специальный поддон с боковинами

** PEZZI SPECIALI - A disposizione solo su richiesta. Tempi di consegna: 30gg.

TRIMS - Available upon request only. Delivery terms: 30 days.

PIÈCES SPECIALES - Disponible seulement sur requête. Délais de livraison: 30 jours.

FORMSTÜCKE - Verfügbar auf Anfrage. Lieferzeit: 30 Tage.

PIEZAS ESPECIALES - Disponible sólo bajo pedido. Plazo de entrega: 30 días.

СПЕЦИАЛЬНЫЕ ЭЛЕМЕНТЫ - Изготавливается только по специальной заявке. Срок поставки: 30 дней.

CALACATTA

LASTRE IN GRES PORCELLANATO PRESSATE A SECCO . DRY-PRESSED PORCELAIN STONEWARE SLABS .
 DALLES EN GRÈS CÉRAME PRESSÉES À SEC . TROCKENGEPRESSTE PLATTEN AUS FEINSTEINZEUG .
 PLANCHAS EN GRÈS PORCELÁNICO PRENSADAS EN SECO . КЕРАМОГРАНИТНЫЕ ПЛИТЫ СУХОГО ПРЕССОВАНИЯ .
 UNI EN 14411-ISO 13006 - Appendice C - Gruppo BIa - UGL

100% DESIGN
AND PRODUCTION
OF ITALY

V2
SHADE SPECTRUM
MODERATE



12 mm

324x163 . 127"x64"
Nat.
Lap. Nat.

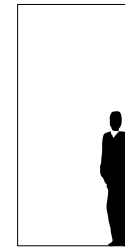

320x160 . 126"x63"
Nat. Ret.
Lap. Ret.



160x160 . 63"x63"
Nat. Ret.
Lap. Ret.



160x80 . 63"x31 1/2"
Nat. Ret.
Lap. Ret.



80x80 . 31 1/2"x31 1/2"
Nat. Ret.
Lap. Ret.



240x120 . 96"x48"
Nat. Ret.
Lap. Ret.

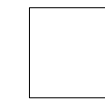

120x120 . 48"x48"
Nat. Ret.
Lap. Ret.



Mosaico 30x30 . 12"x12"
Nat. Ret.
Lap. Ret.

6 mm

modular system

modular system



Slab A
320x160 . 126"x63"
Lap. Ret.

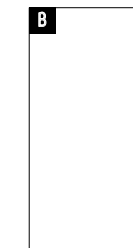

Slab B
320x160 . 126"x63"
Lap. Ret.

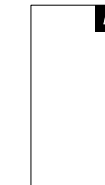

Slab A
240x120 . 96"x48"
Lap. Ret.



Slab B
240x120 . 96"x48"
Lap. Ret.

6 mm

modular system

modular system

INDOOR



120x60 . 48"x24"
Nat. Ret.
Lap. Ret.



60x60 . 24"x24"
Nat. Ret.
Lap. Ret.

10 mm

modular system

SVILUPPO GRAFICO PER FORMATO
Pattern by size
Développement graphique par format
Grafischer Entwurf für Format
Desarrollo gráfico por formato
Варианты графики для каждого формата

320x160
6 mm

320x160
6 mm

160x160
6 mm

160x80
6 mm

80x80
6 mm

240x120
6 mm

240x120
6 mm

120x120
6 mm

120x60
10 mm

60x60
10 mm

324x163
12 mm

7

2
Slab A/B

14

28

24

11

2
Slab A/B

22

20

26

1



Wall
Calacatta 320x160 (126"x63") Lap. Ret.

Porta / Door
Calacatta

Floor
Calacatta 320x160 (126"x63") Lap. Ret.

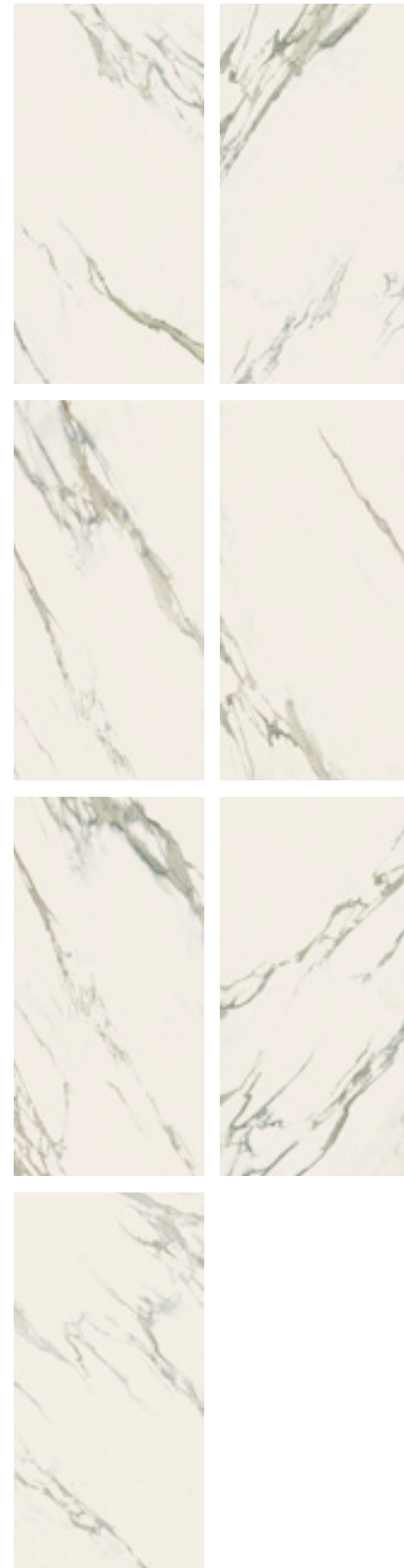
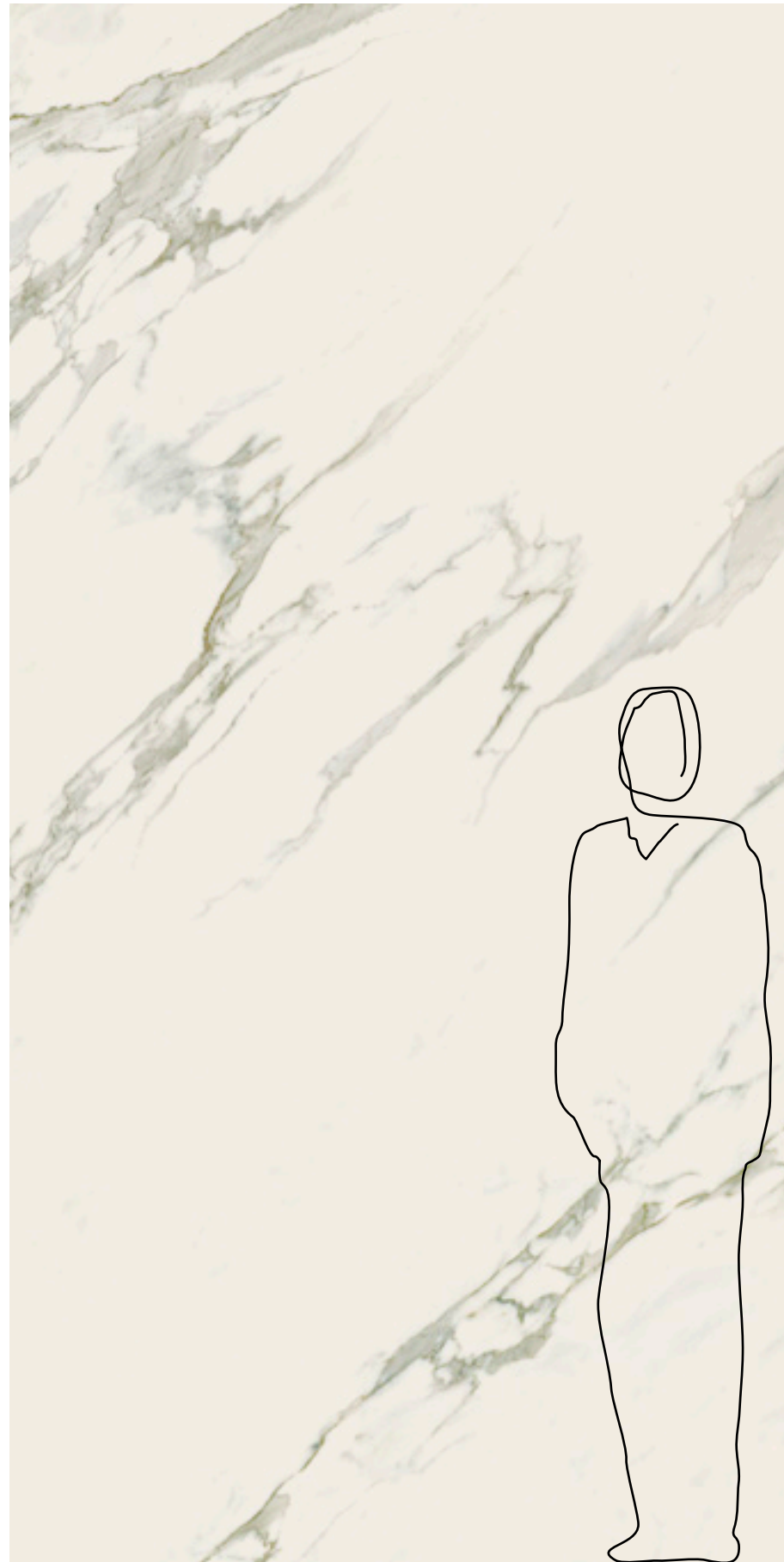

320x160
SVILUPPO GRAFICO PER FORMATO - 7 Pattern by size
 7 Développement graphique par format - 7 Grafischer Entwurf für Format
 7 Desarrollo gráfico por formato - 7 Варианты графики для каждого формата

12 mm

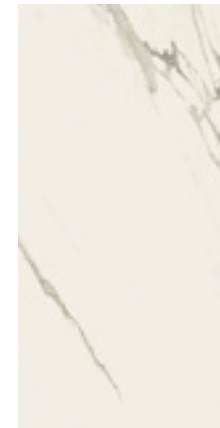

083902
324x163 . 127"x64"
 Nat.
083901
324x163 . 127"x64"
 Lap. Nat.

6 mm



083006
320x160 . 126"x63"
 Nat. Ret.
083005
320x160 . 126"x63"
 Lap. Ret.

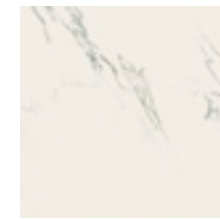

083026
160x160 . 63"x63"
 Nat. Ret.
083025
160x160 . 63"x63"
 Lap. Ret.

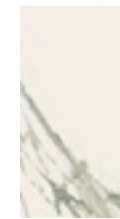

083046
160x80 . 63"x31 1/2"
 Nat. Ret.
083045
160x80 . 63"x31 1/2"
 Lap. Ret.



083056
80x80 . 31 1/2"x31 1/2"
 Nat. Ret.
083055
80x80 . 31 1/2"x31 1/2"
 Lap. Ret.

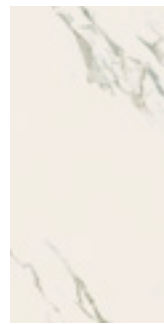

083016
240x120 . 96"x48"
 Nat. Ret.
083015
240x120 . 96"x48"
 Lap. Ret.

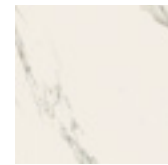

083036
120x120 . 48"x48"
 Nat. Ret.
083035
120x120 . 48"x48"
 Lap. Ret.



Mosaico
083196
30x30 . 12"x12"
 Nat. Ret.
083195
30x30 . 12"x12"
 Lap. Ret.

modular system

modular system

INDOOR

10 mm



083066
120x60 . 48"x24"
 Nat. Ret.
083065
120x60 . 48"x24"
 Lap. Ret.



083086
60x60 . 24"x24"
 Nat. Ret.
083085
60x60 . 24"x24"
 Lap. Ret.

modular system

CALACATTA

6 mm



Slab A
083093
320x160 . 126"x63"
Lap. Ret.

Slab B
083094
320x160 . 126"x63"
Lap. Ret.

modular system

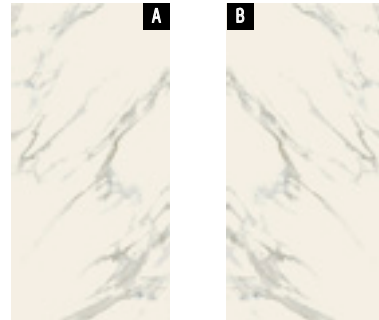

Slab A
083112
240x120 . 96"x48"
Lap. Ret.

Slab B
083113
240x120 . 96"x48"
Lap. Ret.

modular system

Wall
Calacatta 320x160 (126"x63") Lap. Ret.
Calacatta Slab A/B 320x160 (126"x63") Lap. Ret.

Floor
Collection Skyline: Antracite 320x160 (126"x63") Nat. Ret.

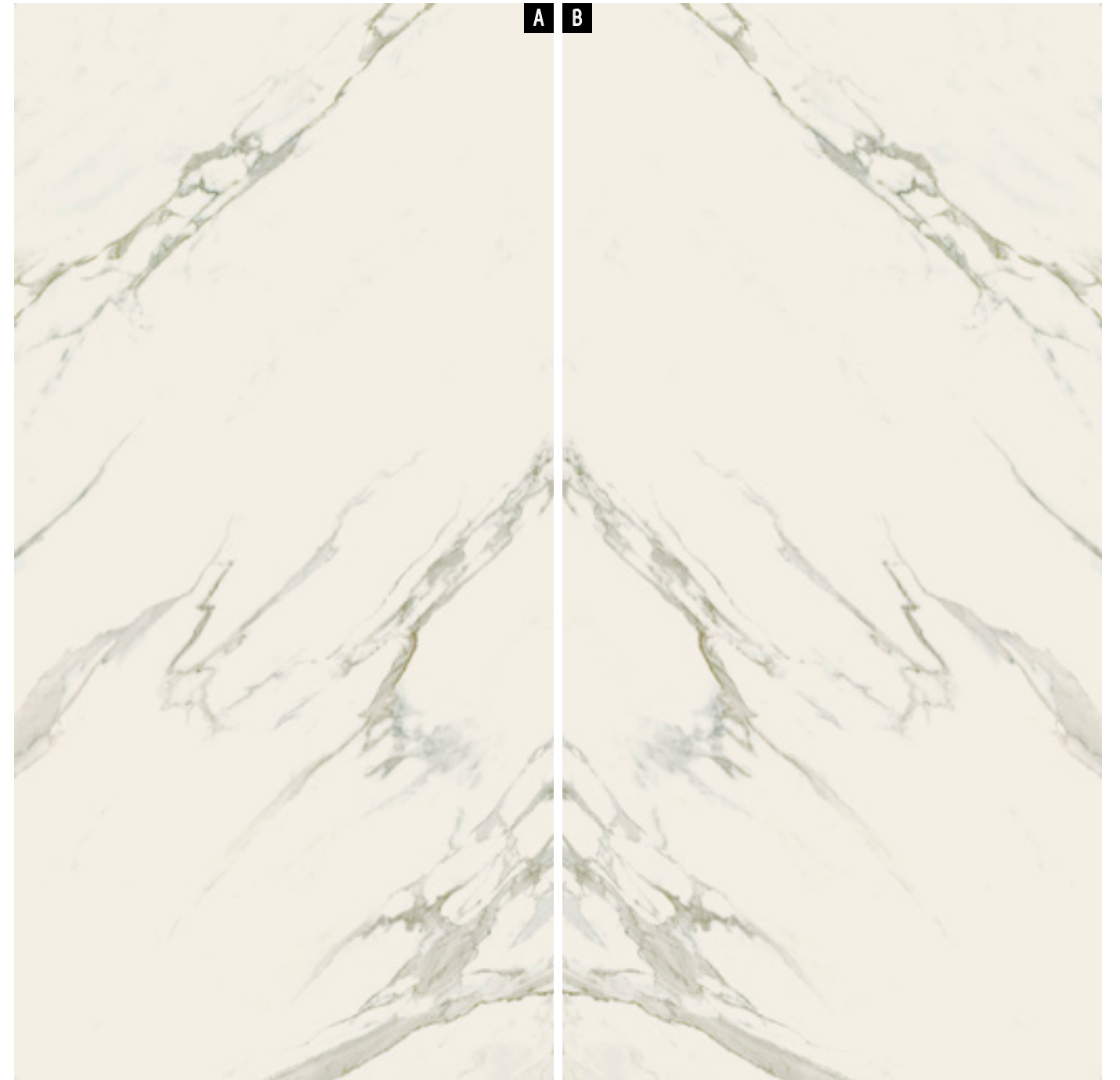

Esempio 1 / Example 1

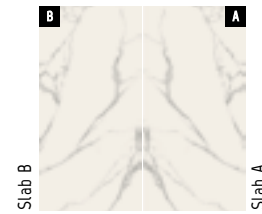

Esempio 2 / Example 2

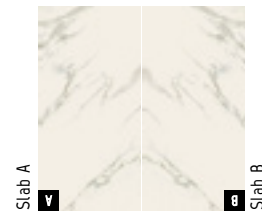

Esempio 3 / Example 3



Esempio 4 / Example 4

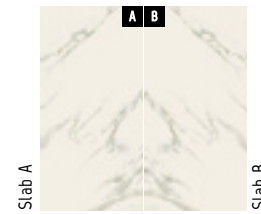





























Esempio 5 / Example 5



CALACATTA

6 mm

SOLO SUPERFICIE NATURALE ONLY NATURAL SURFACE
ANSI A - 137.1: 2012 WET DYNAMIC COEFFICIENT OF FRICTION DCOF ≥ 0,42

	modular system				modular system				Mosaico Mosaic		Slab A/B		Slab A/B		Battiscopa Skirting		Scuretto Rabbeted riser					
	320x160 126"x63" Nat. Ret.	320x160 126"x63" Lap. Ret.	160x160 63"x63" Nat. Ret.	160x160 63"x63" Lap. Ret.	160x80 63"x31 1/2" Nat. Ret.	160x80 63"x31 1/2" Lap. Ret.	80x80 31 1/2"x31 1/2" Nat. Ret.	80x80 31 1/2"x31 1/2" Lap. Ret.	240x120 96"x48" Nat. Ret.	240x120 96"x48" Lap. Ret.	120x120 48"x48" Nat. Ret.	120x120 48"x48" Lap. Ret.	30x30 12"x12" Nat. Ret.	30x30 12"x12" Lap. Ret.	320x160 126"x63" Lap. Ret.	240x120 96"x48" Lap. Ret.	8x80 3"x31 1/2" Nat. Ret.	8x80 3"x31 1/2" Lap. Ret.	20x160 8"x63" Nat. Ret.	20x160 8"x63" Lap. Ret.	20x80 8"x31 1/2" Nat. Ret.	20x80 8"x31 1/2" Lap. Ret.
CALACATTA 	083006	083005	083026	083025	083046	083045	083056	083055	083016	083015	083036	083035	083196	083195	083093 A 083094 B	083112 A 083113 B	083206	083205	083226	083225	083236	083235
PREZZO PRICE	€ 106,00 m ²	€ 130,00 m ²	€ 94,00 m ²	€ 120,00 m ²	€ 74,00 m ²	€ 102,00 m ²	€ 62,00 m ²	€ 76,00 m ²	€ 86,00 m ²	€ 108,00 m ²	€ 74,00 m ²	€ 102,00 m ²	€ 126,00 m ²	€ 168,00 m ²	€ 130,00 m ²	€ 108,00 m ²	€ 7,00 PZ/PCE	€ 8,00 PZ/PCE	€ 30,00 PZ/PCE	€ 42,00 PZ/PCE	€ 22,00 PZ/PCE	€ 30,00 PZ/PCE
CODICE PREZZO PRICE CODE	M173	M197	M161	M187	M141	M169	M129	M143	M153	M175	M141	M169	M193	M235	M197	M175	P025	P029	P077	P101	P061	P077
						EPAL 80x120							EPAL 80x120									
IMBALLO cm h. PACKING cm h.	37	193,5	40,4	193,5	40,9	-	-	-	40	153,5	64,7	153,5	-	-	37	193,5	40	153,5	-	-	40,9	-
Tara / Tare	140,00	210,00	71,80	210,00	-	-	-	-	100,00	158,00	-	158,00	-	-	140,00	210,00	100,00	158,00	-	-	-	-
N°	14	44	24	88	-	-	-	-	20	44	-	88	-	-	14	44	20	44	-	-	-	-
m ² x	5,12	5,12	2,56	2,56	-	-	-	-	2,88	2,88	-	1,44	-	-	5,12	5,12	2,88	2,88	-	-	-	-
Kg x	74,14	74,14	37,07	37,07	-	-	-	-	41,70	41,70	-	20,85	-	-	74,14	74,14	41,70	41,70	-	-	-	-
 x 	-	-	-	-	2	3	-	-	-	-	2	-	-	-	-	-	-	-	12	1	-	1
m ² x 	-	-	-	-	2,56	1,92	-	-	-	-	2,88	-	-	-	-	-	-	-	0,77	-	-	-
Kg x 	-	-	-	-	37,2	27,90	-	-	-	-	41,70	-	-	-	-	-	-	-	11,50	5	-	3
 x 	-	-	-	-	15	40	-	-	-	-	24	-	-	-	-	-	-	-	-	-	-	-
m ² x 	71,68	225,28	61,44	225,28	38,40	76,80	-	-	57,60	126,72	69,12	126,72	-	-	71,68	225,28	57,60	126,72	-	-	-	-
Kg x 	1.178	3.472	962	3.472	648	1.141	-	-	934	1.993	1.057	1.993	-	-	1.178	3.472	934	1.993	-	-	-	-



Cavalletto in legno
Wood A-Frame
Support en bois
Holzgestell
Caballete de madera
Деревянная подставка



Cassa
Crate
Caisse
Kiste
Caja
Ящик



Pallet speciale con sponde
Special pallet with sides
Palette spéciale avec bords
Spezial-Palette mit Wandungen
Palet especial con bordes
Специальный поддон с боковинами

CALACATTA

6 mm

SOLO SUPERFICIE NATURALE
ONLY NATURAL SURFACE
ANSI A - 137.1: 2012
WET DYNAMIC COEFFICIENT OF FRICTION
DCOF ≥ 0,42

	Gradino costa retta Straight nosed stair **						Gradino costa retta - Angolo SX / DX Straight-edge step - LH/RH corner **						Gradino Bordo Dritto Straight-edge step **						Gradino Bordo Dritto - Angolo SX / DX Straight-edge step - LH/RH corner **																	
	33x160x3,2h 13"x63"x1 1/4"h Nat. Ret.		33x160x3,2h 13"x63"x1 1/4"h Lap. Ret.		33x120x3,2h 13"x48"x1 1/4"h Nat. Ret.		33x120x3,2h 13"x48"x1 1/4"h Lap. Ret.		33x80x3,2h 13"x31 1/2"x1 1/4"h Nat. Ret.		33x80x3,2h 13"x31 1/2"x1 1/4"h Lap. Ret.		30x160x4h 12"x63"x1 1/2"h Nat. Ret.		30x160x4h 12"x63"x1 1/2"h Lap. Ret.		30x120x4h 12"x48"x1 1/2"h Nat. Ret.		30x120x4h 12"x48"x1 1/2"h Lap. Ret.		30x80x4h 12"x31 1/2"x1 1/2"h Nat. Ret.		30x80x4h 12"x31 1/2"x1 1/2"h Lap. Ret.		30x160x4h 12"x63"x1 1/2"h Nat. Ret.		30x160x4h 12"x63"x1 1/2"h Lap. Ret.		30x120x4h 12"x48"x1 1/2"h Nat. Ret.		30x120x4h 12"x48"x1 1/2"h Lap. Ret.		30x80x4h 12"x31 1/2"x1 1/2"h Nat. Ret.		30x80x4h 12"x31 1/2"x1 1/2"h Lap. Ret.	
CALACATTA	083256	083255	083264	083265	083276	083275	083335 SX 083296 DX	083336 SX 083295 DX	083344 SX 083304 DX	083345 SX 083305 DX	083354 SX 083314 DX	083355 SX 083315 DX	083374	083375	083384	083385	083396	083395	083454 SX 083414 DX	083455 SX 083415 DX	083464 SX 083424 DX	083465 SX 083425 DX	083474 SX 083434 DX	083475 SX 083435 DX	083374	083375	083384	083385	083396	083395	083454 SX 083414 DX	083455 SX 083415 DX	083464 SX 083424 DX	083465 SX 083425 DX	083474 SX 083434 DX	083475 SX 083435 DX
PREZZO PRICE	€ 272,00 PZ/PCE	€ 312,00 PZ/PCE	€ 176,00 PZ/PCE	€ 198,00 PZ/PCE	€ 100,00 PZ/PCE	€ 108,00 PZ/PCE	€ 304,00 PZ/PCE	€ 344,00 PZ/PCE	€ 212,00 PZ/PCE	€ 232,00 PZ/PCE	€ 136,00 PZ/PCE	€ 148,00 PZ/PCE	€ 178,00 PZ/PCE	€ 200,00 PZ/PCE	€ 126,00 PZ/PCE	€ 134,00 PZ/PCE	€ 68,00 PZ/PCE	€ 76,00 PZ/PCE	€ 240,00 PZ/PCE	€ 276,00 PZ/PCE	€ 178,00 PZ/PCE	€ 190,00 PZ/PCE	€ 116,00 PZ/PCE	€ 130,00 PZ/PCE	€ 178,00 PZ/PCE	€ 200,00 PZ/PCE	€ 126,00 PZ/PCE	€ 134,00 PZ/PCE	€ 68,00 PZ/PCE	€ 76,00 PZ/PCE	€ 240,00 PZ/PCE	€ 276,00 PZ/PCE	€ 178,00 PZ/PCE	€ 190,00 PZ/PCE	€ 116,00 PZ/PCE	€ 130,00 PZ/PCE
CODICE PREZZO PRICE CODE	P303	P323	P243	P265	P167	P175	P319	P339	P273	P283	P203	P215	P245	P267	P193	P201	P135	P143	P287	P305	P245	P257	P183	P197	P245	P267	P193	P201	P135	P143	P287	P305	P245	P257	P183	P197
IMBALLO cm h. PACKING cm h.	168x97		Pallet 80x120		Pallet 80x120		168x97		Pallet 80x120		Pallet 80x120		168x97		Pallet 80x120		Pallet 80x120		168x97		Pallet 80x120		Pallet 80x120		168x97		Pallet 80x120		Pallet 80x120		Pallet 80x120		Pallet 80x120			
Tara / Tare	40,9		-		-		40,9		-		-		40,9		-		-		40,9		-		-		40,9		-		-		-		-		-	
	1	2	2	1	1	1	1	1	1	1	1	1	1	2	2	1	1	1	1	1	1	1	1	1	1	1	1	1	1	1	1	1	1	1		
m ² x	-	-	-	-	-	-	-	-	-	-	-	-	-	-	-	-	-	-	-	-	-	-	-	-	-	-	-	-	-	-	-	-	-	-		
Kg x	9	14	10	10	7	6	10	7	6	6	6	6	8,5	13,5	9	9,5	7	5	9,5	7	5	5	5	5	8,5	13,5	9	9,5	7	5	5	5	5	5	5	
m ² x	-	-	-	-	-	-	-	-	-	-	-	-	-	-	-	-	-	-	-	-	-	-	-	-	-	-	-	-	-	-	-	-	-	-		
Kg x	-	-	-	-	-	-	-	-	-	-	-	-	-	-	-	-	-	-	-	-	-	-	-	-	-	-	-	-	-	-	-	-	-	-		















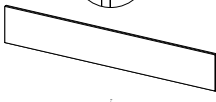
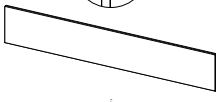
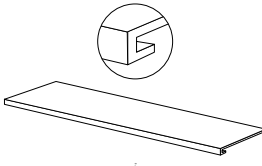
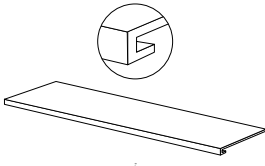
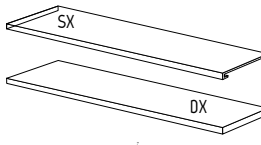
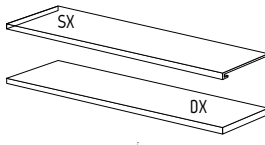
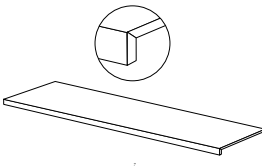
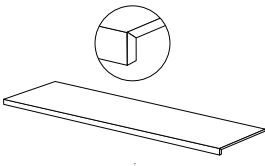
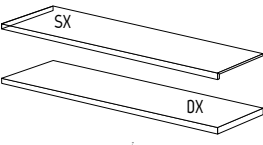
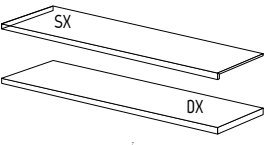

Pallet speciale con sponde
Special pallet with sides
Palette spéciale avec bords
Spezial-Palette mit Wandungen
Palet especial con bordes
Специальный поддон с боковинами

** PEZZI SPECIALI - A disposizione solo su richiesta. Tempi di consegna: 30gg.
TRIMS - Available upon request only. Delivery terms: 30 days.
PIÈCES SPECIALES - Disponible seulement sur requête. Délais de livraison: 30 jours.
FORMSTÜCKE - Verfügbar auf Anfrage. Lieferzeit: 30 Tage.
PIEZAS ESPECIALES - Disponible sólo bajo pedido. Plazo de entrega: 30 días.
СПЕЦИАЛЬНЫЕ ЭЛЕМЕНТЫ - Изготавливается только по специальной заявке. Срок поставки: 30 дней.

CALACATTA INDOOR

10 mm







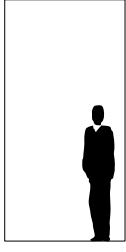

modular system

	modular system				Battiscopa Skirting		Scuretto Rabbeted riser		Gradino costa retta Straight nosed stair **		Gradino costa retta - Angolo SX / DX Straight-edge step - LH/RH corner **		Gradino Bordo Dritto Straight-edge step **		Gradino Bordo Dritto - Angolo SX / DX Straight-edge step - LH/RH corner **	
																
	120x60 48"x24" Nat. Ret.	120x60 48"x24" Lap. Ret.	60x60 24"x24" Nat. Ret.	60x60 24"x24" Lap. Ret.	6,5x120 2 1/2"x48" Nat. Ret.	6,5x120 2 1/2"x48" Lap. Ret.	20x120 8"x48" Nat. Ret.	20x120 8"x48" Lap. Ret.	33x120x3,2h 13"x48"x1 1/4" Nat. Ret.	33x120x3,2h 13"x48"x1 1/4" Lap. Ret.	33x120x3,2h 13"x48"x1 1/4" Nat. Ret.	33x120x3,2h 13"x48"x1 1/4" Lap. Ret.	30x120x4h 12"x48"x1 1/2" Nat. Ret.	30x120x4h 12"x48"x1 1/2" Lap. Ret.	30x120x4h 12"x48"x1 1/2" Nat. Ret.	30x120x4h 12"x48"x1 1/2" Lap. Ret.
CALACATTA	083066	083065	083086	083085	083216	083215	083244	083245	083286	083285	083364 SX 083324 DX	083365 SX 083325 DX	083404	083405	083484 SX 083444 DX	083485 SX 083445 DX
PREZZO PRICE	€ 46,00 m ²	€ 58,00 m ²	€ 36,00 m ²	€ 48,00 m ²	€ 8,00 PZ/PCE	€ 9,00 PZ/PCE	€ 26,00 PZ/PCE	€ 28,00 PZ/PCE	€ 140,00 PZ/PCE	€ 148,00 PZ/PCE	€ 164,00 PZ/PCE	€ 176,00 PZ/PCE	€ 106,00 PZ/PCE	€ 112,00 PZ/PCE	€ 134,00 PZ/PCE	€ 134,00 PZ/PCE
CODICE PREZZO PRICE CODE	M109	M125	M089	M113	P029	P033	P069	P073	P207	P215	P231	P243	P173	P179	P201	P201
IMBALLO cm h. PACKING cm h.	EPAL 80x120	EPAL 80x120	EPAL 80x120	EPAL 80x120	Pallet 80x120	Pallet 80x120	Pallet 80x120	Pallet 80x120	Pallet 80x120	Pallet 80x120	Pallet 80x120	Pallet 80x120	Pallet 80x120	Pallet 80x120	Pallet 80x120	Pallet 80x120
Tara / Tare	20	20	-	-	-	-	-	-	-	-	-	-	-	-	-	-
 x 	2	3	6	1	2	1	2	1	2	1	2	1	2	1	1	1
m ² x 	1,44	1,08	-	-	-	-	-	-	-	-	-	-	-	-	-	-
Kg x 	33,41	24,80	11,4	12	22	11	22	11	22	11	22	11	22	11	11	11
 x 	30	40	-	-	-	-	-	-	-	-	-	-	-	-	-	-
m ² x 	43,2	43,2	-	-	-	-	-	-	-	-	-	-	-	-	-	-
Kg x 	1.025	1.012	-	-	-	-	-	-	-	-	-	-	-	-	-	-

SOLO SUPERFICIE NATURALE
ONLY NATURAL SURFACE

ANSI A - 137.1: 2012
WET DYNAMIC COEFFICIENT OF FRICTION | DCOF ≥ 0,42

12 mm

	324x163 127"x64" Nat.		324x163 127"x64" Lap. Nat.	
CALACATTA	083902	083901	083902	083901
PREZZO PRICE	€ 154,00 m ²	€ 180,00 m ²	€ 154,00 m ²	€ 180,00 m ²
CODICE PREZZO PRICE CODE	M221	M247	M221	M247
IMBALLO cm h. PACKING cm h.				
Tara / Tare	37	193,5	37	193,5
N°	10	22	10	22
m ² x 	5,28	5,28	5,28	5,28
Kg x 	152,47	152,47	152,47	152,47
m ² x 	52,80	116,16	52,80	116,16
Kg x 	1.674	3.583	1.674	3.613

**

PEZZI SPECIALI - A disposizione solo su richiesta. Tempi di consegna: 30gg.

TRIMS - Available upon request only. Delivery terms: 30 days.

PIÈCES SPECIALES - Disponible seulement sur requête. Délais de livraison: 30 jours.

FORMSTÜCKE - Verfügbar auf Anfrage. Lieferzeit: 30 Tage.

PIEZAS ESPECIALES - Disponible sólo bajo pedido. Plazo de entrega: 30 días.

СПЕЦИАЛНЫЕ ЭЛЕМЕНТЫ - Изготавливается только по специальной заявке. Срок поставки: 30 дней.



Cassa
Crate
Caisse
Kiste
Caja
Ящик



Cavalletto in legno
Wood A-Frame
Support en bois
Holzgestell
Caballete de madera
Деревянная подставка



Cavalletto in ferro
Iron A-Frame
Support en fer
Metallgestell
Caballete de hierro
Металлическая подставка

COPACABANA DUKE

LASTRE IN GRES PORCELLANATO PRESSATE A SECCO . DRY-PRESSED PORCELAIN STONEWARE SLABS .
DALLES EN GRÈS CÉRAMÉ PRESSÉES À SEC . TROCKENGEPRESSTE PLATTEN AUS FEINSTEINZEUG .
PLANCHAS EN GRÈS PORCELÁNICO PRENSADAS EN SECO . КЕРАМОГРАНИТНЫЕ ПЛИТЫ СУХОГО ПРЕССОВАНИЯ .
UNI EN 14411-ISO 13006 - Appendice C - Gruppo BIa - UGL

100% DESIGN
AND PRODUCTION
OF ITALY

V2
SHADE SPECTRUM
MODERATE

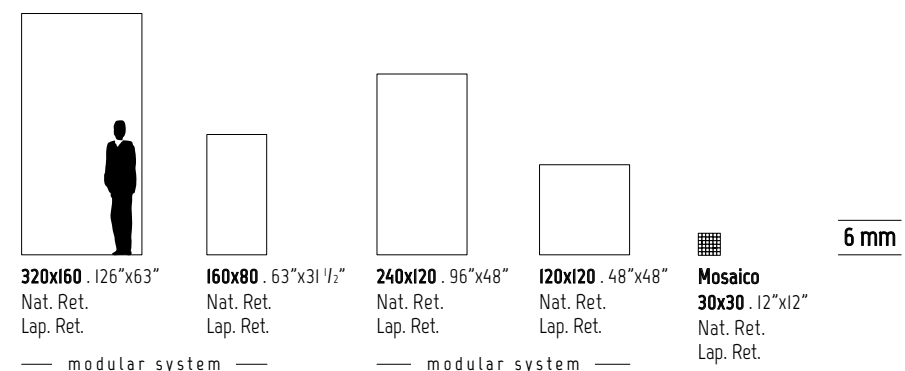

INDOOR

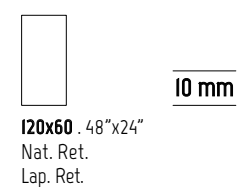

SVILUPPO GRAFICO PER FORMATO Pattern by size Développement graphique par format Grafischer Entwurf für Format Desarrollo gráfico por formato Варианты графики для каждого формата	320x160 6 mm	160x80 6 mm	240x120 6 mm	120x120 6 mm	120x60 10 mm
	7	28	11	22	28

COPACABANA DUKE

Wall
Copacabana Duke 320x160 (126"x63") Lap. Ret.

Rivestimento parete sx / Left wall tile
Collection Marmo & Pietra: Lasa 320x160 (126"x63") Lap. Ret.

Floor
Collection Marmo & Pietra: Lasa 120x120 (48"x48") Lap. Ret.





320x160
SVILUPPO GRAFICO PER FORMATO - 7 Pattern by size
 7 Développement graphique par format - 7 Grafischer Entwurf für Format
 7 Desarrollo gráfico por formato - 7 Варианты графики для каждого формата

6 mm



081006
320x160 . 126"x63"
 Nat. Ret.

081005
320x160 . 126"x63"
 Lap. Ret.

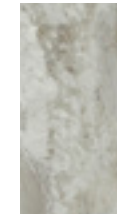

081086
160x80 . 63"x31 1/2"
 Nat. Ret.

081085
160x80 . 63"x31 1/2"
 Lap. Ret.



081026
240x120 . 96"x48"
 Nat. Ret.

081025
240x120 . 96"x48"
 Lap. Ret.



081056
120x120 . 48"x48"
 Nat. Ret.

081055
120x120 . 48"x48"
 Lap. Ret.



Mosaico
081175
30x30 . 12"x12"
 Nat. Ret.

081176
30x30 . 12"x12"
 Lap. Ret.

modular system

modular system

INDOOR

10 mm



081126
120x60 . 48"x24"
 Nat. Ret.

081125
120x60 . 48"x24"
 Lap. Ret.

COPACABANA DUKE

6 mm

SOLO SUPERFICIE NATURALE
ONLY NATURAL SURFACE

ANSI A - 137.1: 2012
WET DYNAMIC COEFFICIENT OF FRICTION
DCOF ≥ 0,42

COPACABANA DUKE	modular system				modular system				Mosaico Mosaic		Battiscopa Skirting		Scuretto Rabbeted riser		Gradino costa retta Straight nosed stair **				Gradino costa retta - Angolo SX / DX Straight-edge step - LH/RH corner **				Gradino Bordo Dritto Straight-edge step **				Gradino Bordo Dritto - Angolo SX / DX Straight-edge step - LH/RH corner **					
	320x160 126"x63" Nat. Ret.	320x160 126"x63" Lap. Ret.	160x80 63"x31 1/2" Nat. Ret.	160x80 63"x31 1/2" Lap. Ret.	240x120 96"x48" Nat. Ret.	240x120 96"x48" Lap. Ret.	120x120 48"x48" Nat. Ret.	120x120 48"x48" Lap. Ret.	30x30 12"x12" Nat. Ret.	30x30 12"x12" Lap. Ret.	8x80 3"x31 1/2" Nat. Ret.	8x80 3"x31 1/2" Lap. Ret.	20x160 8"x63" Nat. Ret.	20x160 8"x63" Lap. Ret.	20x80 8"x31 1/2" Nat. Ret.	20x80 8"x31 1/2" Lap. Ret.	33x160x3,2h 13"x63"x1 1/4" Nat. Ret.	33x160x3,2h 13"x63"x1 1/4" Lap. Ret.	33x120x3,2h 13"x48"x1 1/4" Nat. Ret.	33x120x3,2h 13"x48"x1 1/4" Lap. Ret.	33x160x3,2h 13"x63"x1 1/4" Nat. Ret.	33x160x3,2h 13"x63"x1 1/4" Lap. Ret.	33x120x3,2h 13"x48"x1 1/4" Nat. Ret.	33x120x3,2h 13"x48"x1 1/4" Lap. Ret.	30x160x4h 12"x63"x1 1/2" Nat. Ret.	30x160x4h 12"x63"x1 1/2" Lap. Ret.	30x120x4h 12"x48"x1 1/2" Nat. Ret.	30x120x4h 12"x48"x1 1/2" Lap. Ret.	30x160x4h 12"x63"x1 1/2" Nat. Ret.	30x160x4h 12"x63"x1 1/2" Lap. Ret.	30x120x4h 12"x48"x1 1/2" Nat. Ret.	30x120x4h 12"x48"x1 1/2" Lap. Ret.
	081006	081005	081086	081085	081026	081025	081056	081055	081175	081176	081216	081215	081226	081225	081256	081255	081267	081265	081276	081275	081356 SX 081306 DX	081355 SX 081305 DX	081366 SX 081316 DX	081365 SX 081315 DX	081396	081395	081406	081405	081466 SX 081426 DX	081465 SX 081425 DX	081476 SX 081436 DX	081475 SX 081435 DX
PREZZO PRICE	€ 106,00 m ²	€ 130,00 m ²	€ 74,00 m ²	€ 102,00 m ²	€ 86,00 m ²	€ 108,00 m ²	€ 74,00 m ²	€ 102,00 m ²	€ 126,00 m ²	€ 168,00 m ²	€ 7,00 PZ/PCE	€ 11,00 PZ/PCE	€ 30,00 PZ/PCE	€ 42,00 PZ/PCE	€ 22,00 PZ/PCE	€ 30,00 PZ/PCE	€ 272,00 PZ/PCE	€ 312,00 PZ/PCE	€ 176,00 PZ/PCE	€ 198,00 PZ/PCE	€ 304,00 PZ/PCE	€ 344,00 PZ/PCE	€ 212,00 PZ/PCE	€ 232,00 PZ/PCE	€ 178,00 PZ/PCE	€ 200,00 PZ/PCE	€ 126,00 PZ/PCE	€ 134,00 PZ/PCE	€ 240,00 PZ/PCE	€ 276,00 PZ/PCE	€ 178,00 PZ/PCE	€ 190,00 PZ/PCE
CODICE PREZZO PRICE CODE	M173	M197	M141	M169	M153	M175	M141	M169	M193	M235	P025	P039	P077	P101	P061	P077	P303	P323	P243	P265	P319	P339	P273	P283	P245	P267	P193	P201	P287	P305	P245	P257
IMBALLO cm h. PACKING cm h.	345x175	330x75	168x97	264x136,6	250x75	143x123	250x75	EPAL 80x120	Pallet 80x120	168x97	Pallet 80x120	168x97	Pallet 80x120	168x97	Pallet 80x120	168x97	40,9	-	40,9	-	40,9	-	40,9	-	40,9	-	40,9	-	40,9	-	40,9	-
Tara / Tare	140,00	210,00	-	100,00	158,00	-	158,00	-	-	-	-	-	-	-	-	-	-	-	-	-	-	-	-	-	-	-	-	-	-	-	-	-
N°	14	44	-	20	44	-	88	-	-	-	-	-	-	-	-	-	-	-	-	-	-	-	-	-	-	-	-	-	-	-	-	-
m ² x	5,12	5,12	-	2,88	2,88	-	1,44	-	-	-	-	-	-	-	-	-	-	-	-	-	-	-	-	-	-	-	-	-	-	-	-	-
Kg x	74,14	74,14	-	41,70	41,70	-	20,85	-	-	-	-	-	-	-	-	-	-	-	-	-	-	-	-	-	-	-	-	-	-	-	-	-
m ² x	-	-	2	-	-	2	-	-	12	1	1	-	-	-	-	-	1	2	1	1	1	1	1	1	1	2	1	1	1	1	1	
Kg x	-	-	2,56	-	-	2,88	-	-	0,77	-	-	-	-	-	-	-	-	-	-	-	-	-	-	-	-	-	-	-	-	-	-	-
m ² x	-	-	37,2	-	-	41,70	-	-	11,50	5	3	-	-	-	-	-	9	14	10	7	7	7	7	7	8,5	13,5	9,5	9,5	7	7	7	
Kg x	-	-	15	-	-	24	-	-	-	-	-	-	-	-	-	-	-	-	-	-	-	-	-	-	-	-	-	-	-	-	-	-
m ² x	71,68	225,28	38,40	57,60	126,72	69,12	126,72	-	-	-	-	-	-	-	-	-	-	-	-	-	-	-	-	-	-	-	-	-	-	-	-	-
Kg x	1.178	3.472	648	934	1.993	1.057	1.993	-	-	-	-	-	-	-	-	-	-	-	-	-	-	-	-	-	-	-	-	-	-	-	-	-



Cavalletto in legno
Wood A-Frame
Support en bois
Holzgestell
Caballete de madera
Деревянная подставка



Cassa
Crate
Caisse
Kiste
Caja
Ящик



Pallet speciale con sponde
Special pallet with sides
Palette spéciale avec bords
Spezial-Palette mit Wandungen
Palet especial con bordes
Специальный поддон с боковинами

** PEZZI SPECIALI - A disposizione solo su richiesta. Tempi di consegna: 30gg.

TRIMS - Available upon request only. Delivery terms: 30 days.

PIÈCES SPECIALES - Disponible seulement sur requête. Délais de livraison: 30 jours.

FORMSTÜCKE - Verfügbar auf Anfrage. Lieferzeit: 30 Tage.

PIEZAS ESPECIALES - Disponible sólo bajo pedido. Plazo de entrega: 30 días.













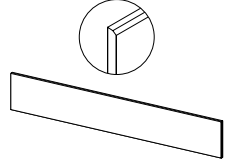
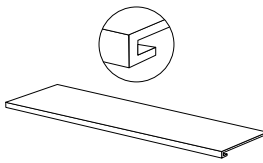

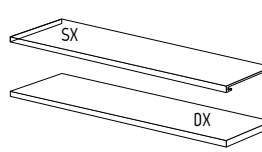

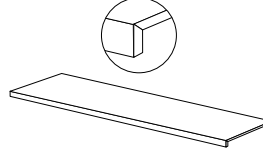
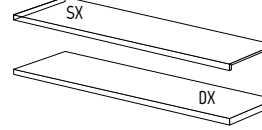
СПЕЦИАЛЬНЫЕ ЭЛЕМЕНТЫ - Изготавливается только по специальной заявке. Срок поставки: 30 дней.

COPACABANA DUKE INDOOR

10 mm

SOLO SUPERFICIE NATURALE
ONLY NATURAL SURFACE

ANSI A - 137.1: 2012
WET DYNAMIC COEFFICIENT OF FRICTION | DCOF ≥ 0,42

	Battiscopa Skirting		Scuretto Rabbeted riser		Gradino costa retta Straight nosed stair **		Gradino costa retta - Angolo SX / DX Straight-edge step - LH/RH corner **		Gradino Bordo Dritto Straight-edge step **		Gradino Bordo Dritto - Angolo SX / DX Straight-edge step - LH/RH corner **			
														
	120x60 48"x24" Nat. Ret.	120x60 48"x24" Lap. Ret.	6,5x120 2 1/2"x48" Nat. Ret.	6,5x120 2 1/2"x48" Lap. Ret.	20x120 8"x48" Nat. Ret.	20x120 8"x48" Lap. Ret.	33x120x3,2h 13"x48"x1 1/4" h Nat. Ret.	33x120x3,2h 13"x48"x1 1/4" h Lap. Ret.	33x120x3,2h 13"x48"x1 1/4" h Nat. Ret.	33x120x3,2h 13"x48"x1 1/4" h Lap. Ret.	30x120x4h 12"x48"x1 1/2" h Nat. Ret.	30x120x4h 12"x48"x1 1/2" h Lap. Ret.	30x120x4h 12"x48"x1 1/2" h Nat. Ret.	30x120x4h 12"x48"x1 1/2" h Lap. Ret.
COPACABANA DUKE	081126	081125	081206	081205	081246	081245	081286	081285	081376 SX 081326 DX	081375 SX 081325 DX	081416	081415	081486 SX 081446 DX	081485 SX 081445 DX
PREZZO PRICE	€ 46,00 m ²	€ 58,00 m ²	€ 8,00 PZ/PCE	€ 9,00 PZ/PCE	€ 26,00 PZ/PCE	€ 28,00 PZ/PCE	€ 140,00 PZ/PCE	€ 148,00 PZ/PCE	€ 164,00 PZ/PCE	€ 176,00 PZ/PCE	€ 106,00 PZ/PCE	€ 112,00 PZ/PCE	€ 134,00 PZ/PCE	€ 134,00 PZ/PCE
CODICE PREZZO PRICE CODE	M109	M125	P029	P033	P069	P073	P207	P215	P231	P243	P173	P179	P201	P201
IMBALLO cm h. PACKING cm h.	EPAL 80x120		Pallet 80x120		Pallet 80x120		Pallet 80x120		Pallet 80x120		Pallet 80x120		Pallet 80x120	
Tara / Tare	20		-		-		-		-		-		-	
 x 	2		6		1		2		1		2		1	
m ² x 	1,44		-		-		-		-		-		-	
Kg x 	33,41		11,4		12		22		11		22		11	
 x 	30		-		-		-		-		-		-	
m ² x 	43,2		-		-		-		-		-		-	
Kg x 	1.025		-		-		-		-		-		-	



Wall
Copacabana Duke 160x80 (63"x31 1/2") Nat. Ret.

Vasca da bagno / Bathtub
Copacabana Duke 240x120 (96"x48") Nat. Ret.

Floor
Copacabana Duke 160x80 (63"x31 1/2") Nat. Ret.

**

PEZZI SPECIALI - A disposizione solo su richiesta. Tempi di consegna: 30gg.

TRIMS - Available upon request only. Delivery terms: 30 days.

PIÈCES SPECIALES - Disponible seulement sur requête. Délais de livraison: 30 jours.

FORMSTÜCKE - Verfügbar auf Anfrage. Lieferzeit: 30 Tage.

PIEZAS ESPECIALES - Disponible sólo bajo pedido. Plazo de entrega: 30 días.

СПЕЦИАЛНЫЕ ЭЛЕМЕНТЫ - Изготавливается только по специальной заявке. Срок поставки: 30 дней.

COPACABANA EMPEROR

LASTRE IN GRES PORCELLANATO PRESSATE A SECCO . DRY-PRESSED PORCELAIN STONWARE SLABS .
DALLES EN GRÈS CÉRAMÉ PRESSÉES À SEC . TROCKENGEPRESSTE PLATTEN AUS FEINSTEINZEUG .
PLANCHAS EN GRÉS PORCELÁNICO PRENSADAS EN SECO . КЕРАМОГРАНИТНЫЕ ПЛИТЫ СУХОГО ПРЕССОВАНИЯ .
UNI EN 14411-ISO 13006 - Appendice C - Gruppo BIa - UCL

100% DESIGN
AND PRODUCTION
OF ITALY

V2
SHADE SPECTRUM
MODERATE

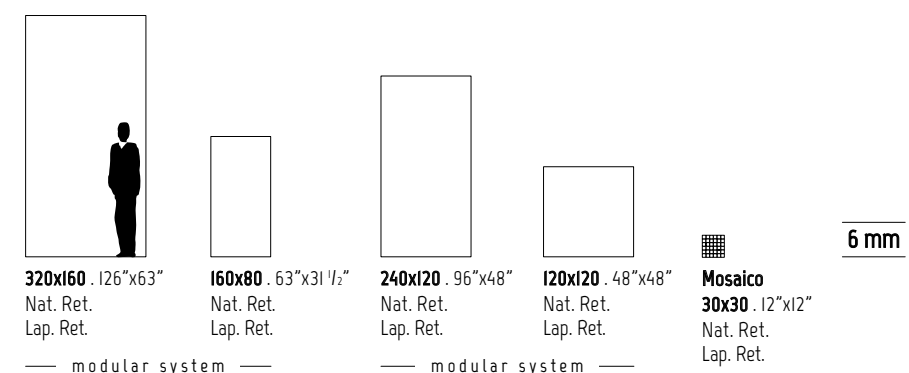

INDOOR

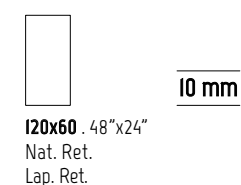

SVILUPPO GRAFICO PER FORMATO Pattern by size Développement graphique par format Grafischer Entwurf für Format Desarrollo gráfico por formato Варианты графики для каждого формата	320x160 6 mm	160x80 6 mm	240x120 6 mm	120x120 6 mm	120x60 10 mm
	7	28	11	22	28



Wall
Copacabana Princess 320x160 (126"x63") Lap. Ret.

Floor
Copacabana Emperor 320x160 (126"x63") Lap. Ret.

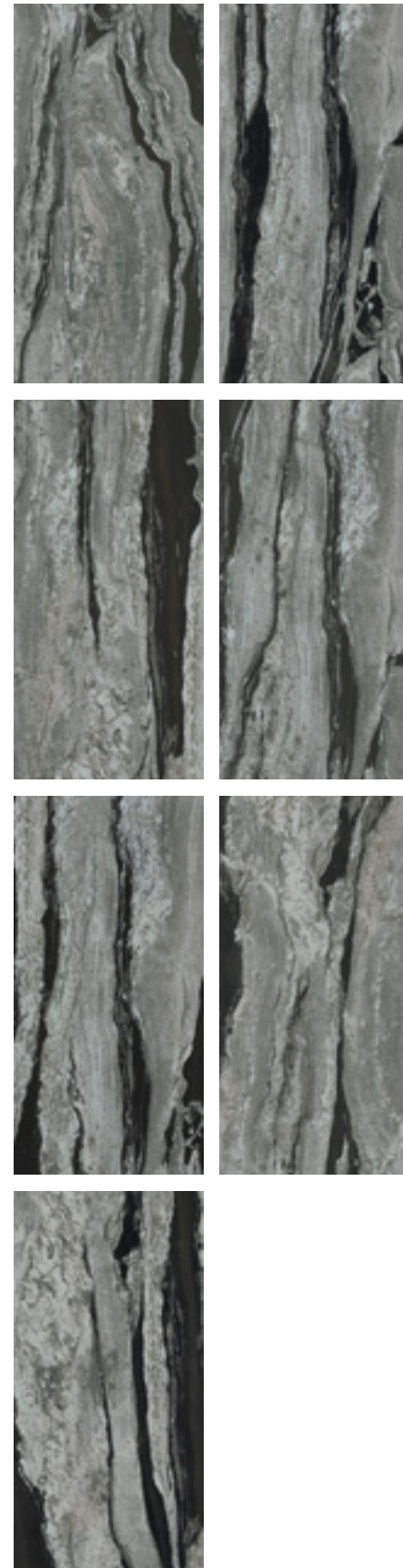
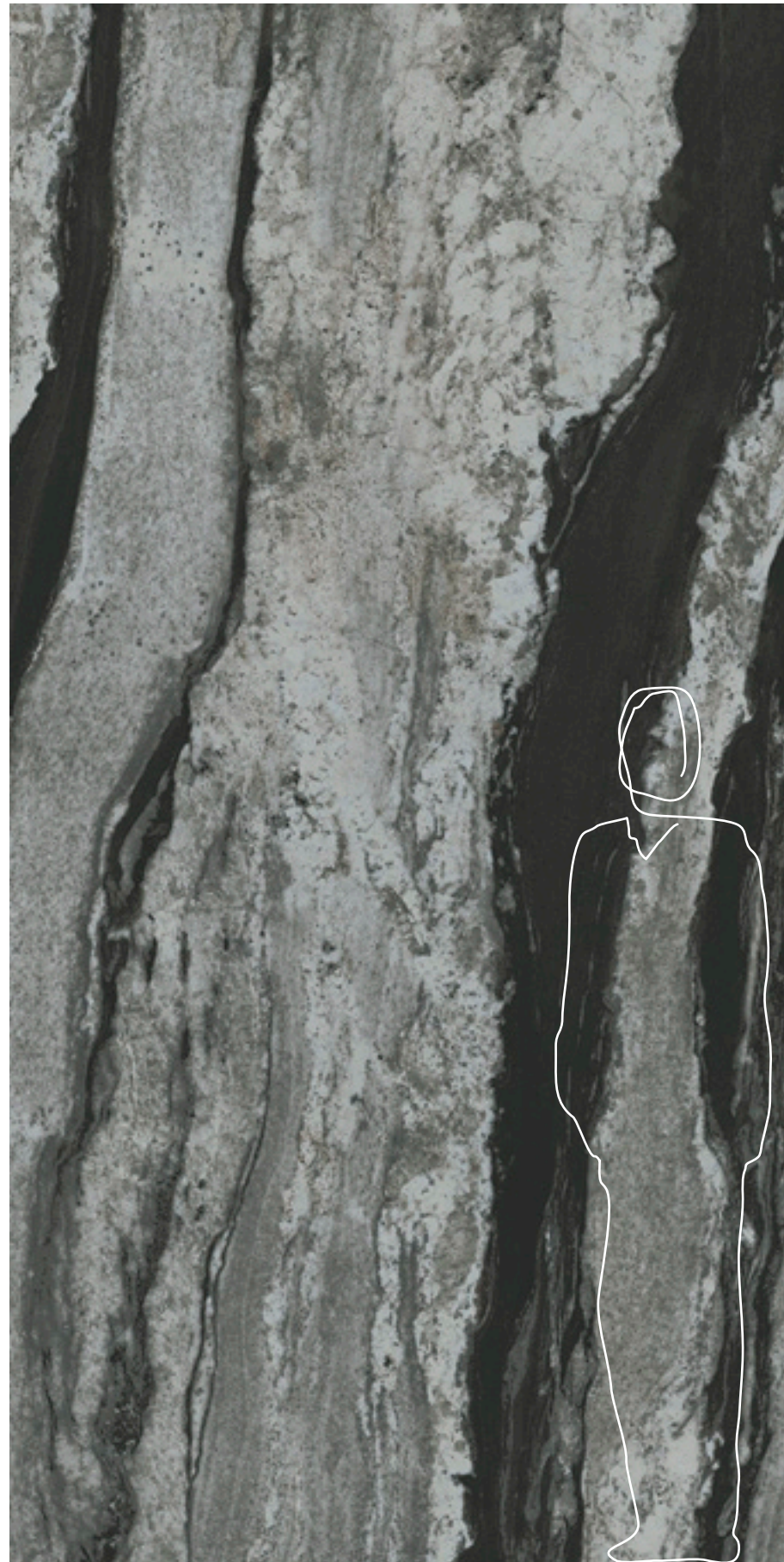

320x160
SVILUPPO GRAFICO PER FORMATO - 7 Pattern by size
7 Développement graphique par format - 7 Grafischer Entwurf für Format
7 Desarrollo gráfico por formato - 7 Варианты графики для каждого формата

6 mm



081010
320x160 . 126"x63"
Nat. Ret.

081009
320x160 . 126"x63"
Lap. Ret.



081090
160x80 . 63"x31 1/2"
Nat. Ret.

081089
160x80 . 63"x31 1/2"
Lap. Ret.



081030
240x120 . 96"x48"
Nat. Ret.

081029
240x120 . 96"x48"
Lap. Ret.



081060
120x120 . 48"x48"
Nat. Ret.

081059
120x120 . 48"x48"
Lap. Ret.



Mosaico
081179
30x30 . 12"x12"
Nat. Ret.

081180
30x30 . 12"x12"
Lap. Ret.

modular system

modular system

INDOOR

10 mm



081130
120x60 . 48"x24"
Nat. Ret.

081129
120x60 . 48"x24"
Lap. Ret.

COPACABANA EMPEROR

6 mm

SOLO SUPERFICIE NATURALE
ONLY NATURAL SURFACE

ANSI A - 137.1: 2012
WET DYNAMIC COEFFICIENT OF FRICTION
DCOF ≥ 0,42

	modular system				modular system				Mosaico Mosaic		Battiscopa Skirting		Scretto Rabbeted riser		Gradino costa retta Straight nosed stair **				Gradino costa retta - Angolo SX / DX Straight-edge step - LH/RH corner **				Gradino Bordo Dritto Straight-edge step **				Gradino Bordo Dritto - Angolo SX / DX Straight-edge step - LH/RH corner **								
	320x160 126"x63" Nat. Ret.	320x160 126"x63" Lap. Ret.	160x80 63"x31 1/2" Nat. Ret.	160x80 63"x31 1/2" Lap. Ret.	240x120 96"x48" Nat. Ret.	240x120 96"x48" Lap. Ret.	120x120 48"x48" Nat. Ret.	120x120 48"x48" Lap. Ret.	30x30 12"x12" Nat. Ret.	30x30 12"x12" Lap. Ret.	8x80 3"x31 1/2" Nat. Ret.	8x80 3"x31 1/2" Lap. Ret.	20x160 8"x63" Nat. Ret.	20x160 8"x63" Lap. Ret.	20x80 8"x31 1/2" Nat. Ret.	20x80 8"x31 1/2" Lap. Ret.	33x160x3,2h 13"x63"x11/4"h Nat. Ret.	33x160x3,2h 13"x63"x11/4"h Lap. Ret.	33x120x3,2h 13"x48"x11/4"h Nat. Ret.	33x120x3,2h 13"x48"x11/4"h Lap. Ret.	33x160x3,2h 13"x63"x11/4"h Nat. Ret.	33x160x3,2h 13"x63"x11/4"h Lap. Ret.	33x120x3,2h 13"x48"x11/4"h Nat. Ret.	33x120x3,2h 13"x48"x11/4"h Lap. Ret.	30x160x4h 12"x63"x11/2"h Nat. Ret.	30x160x4h 12"x63"x11/2"h Lap. Ret.	30x120x4h 12"x48"x11/2"h Nat. Ret.	30x120x4h 12"x48"x11/2"h Lap. Ret.	30x160x4h 12"x63"x11/2"h Nat. Ret.	30x160x4h 12"x63"x11/2"h Lap. Ret.	30x120x4h 12"x48"x11/2"h Nat. Ret.	30x120x4h 12"x48"x11/2"h Lap. Ret.			
COPACABANA EMPEROR	081010	081009	081090	081089	081030	081029	081060	081059	081179	081180	081220	081219	081230	081229	081260	081259	081270	081269	081280	081279	081360 SX 081310 DX	081359 SX 081309 DX	081370 SX 081320 DX	081369 SX 081319 DX	081400	081399	081410	081409	081470 SX 081430 DX	081469 SX 081429 DX	081480 SX 081440 DX	081479 SX 081439 DX			
PREZZO PRICE	€ 106,00 m ²	€ 130,00 m ²	€ 74,00 m ²	€ 102,00 m ²	€ 86,00 m ²	€ 108,00 m ²	€ 74,00 m ²	€ 102,00 m ²	€ 126,00 m ²	€ 168,00 m ²	€ 7,00 PZ/PCE	€ 11,00 PZ/PCE	€ 30,00 PZ/PCE	€ 42,00 PZ/PCE	€ 22,00 PZ/PCE	€ 30,00 PZ/PCE	€ 272,00 PZ/PCE	€ 312,00 PZ/PCE	€ 176,00 PZ/PCE	€ 198,00 PZ/PCE	€ 304,00 PZ/PCE	€ 344,00 PZ/PCE	€ 212,00 PZ/PCE	€ 232,00 PZ/PCE	€ 178,00 PZ/PCE	€ 200,00 PZ/PCE	€ 126,00 PZ/PCE	€ 134,00 PZ/PCE	€ 240,00 PZ/PCE	€ 276,00 PZ/PCE	€ 178,00 PZ/PCE	€ 190,00 PZ/PCE			
CODICE PREZZO PRICE CODE	M173	M197	M141	M169	M153	M175	M141	M169	M193	M235	P025	P039	P077	P101	P061	P077	P303	P323	P243	P265	P319	P339	P273	P283	P245	P267	P193	P201	P287	P305	P245	P257			
IMBALLO cm h. PACKING cm h.	345x175	330x75	168x97	264x136,6	250x75	143x123	250x75	EPAL 80x120	Pallet 80x120	168x97	Pallet 80x120	168x97	Pallet 80x120	168x97	Pallet 80x120	168x97	Pallet 80x120	168x97	Pallet 80x120	168x97	Pallet 80x120	168x97	Pallet 80x120	168x97	Pallet 80x120	168x97	Pallet 80x120	168x97	Pallet 80x120	168x97	Pallet 80x120	168x97	Pallet 80x120		
Tara / Tare	140,00	210,00	-	100,00	158,00	-	158,00	-	-	-	-	-	-	-	-	-	-	-	-	-	-	-	-	-	-	-	-	-	-	-	-	-	-	-	
N°	14	44	-	20	44	-	88	-	-	-	-	-	-	-	-	-	-	-	-	-	-	-	-	-	-	-	-	-	-	-	-	-	-	-	
m ² x	5,12	5,12	-	2,88	2,88	-	1,44	-	-	-	-	-	-	-	-	-	-	-	-	-	-	-	-	-	-	-	-	-	-	-	-	-	-	-	
Kg x	74,14	74,14	-	41,70	41,70	-	20,85	-	-	-	-	-	-	-	-	-	-	-	-	-	-	-	-	-	-	-	-	-	-	-	-	-	-	-	
m ² x	-	-	2	-	-	2	-	-	12	1	1	1	1	2	1	1	1	2	1	1	1	1	1	1	1	1	2	1	1	1	1	1	1	1	
Kg x	-	-	37,2	-	-	41,70	-	-	11,50	5	3	9	14	10	7	8,5	13,5	9,5	7	7	7	7	7	7	8,5	13,5	9,5	7	7	7	7	7	7		
m ² x	71,68	225,28	38,40	57,60	126,72	69,12	126,72	-	-	-	-	-	-	-	-	-	-	-	-	-	-	-	-	-	-	-	-	-	-	-	-	-	-	-	
Kg x	1.178	3.472	648	934	1.993	1.057	1.993	-	-	-	-	-	-	-	-	-	-	-	-	-	-	-	-	-	-	-	-	-	-	-	-	-	-	-	-



Cavalletto in legno
Wood A-Frame
Support en bois
Holzgestell
Caballete de madera
Деревянная подставка



Cassa
Crate
Caisse
Kiste
Caja
Ящик



Pallet speciale con sponde
Special pallet with sides
Palette spéciale avec bords
Spezial-Palette mit Wandungen
Palet especial con bordes
Специальный поддон с боковинами

** PEZZI SPECIALI - A disposizione solo su richiesta. Tempi di consegna: 30gg.
TRIMS - Available upon request only. Delivery terms: 30 days.
PIÈCES SPECIALES - Disponible seulement sur requête. Délais de livraison: 30 jours.
FORMSTÜCKE - Verfügbar auf Anfrage. Lieferzeit: 30 Tage.
PIEZAS ESPECIALES - Disponible sólo bajo pedido. Plazo de entrega: 30 días.
СПЕЦИАЛЬНЫЕ ЭЛЕМЕНТЫ - Изготавливается только по специальной заявке. Срок поставки: 30 дней.

COPACABANA EMPEROR INDOOR

10 mm

SOLO SUPERFICIE NATURALE
ONLY NATURAL SURFACE

ANSI A - 137.1: 2012
WET DYNAMIC COEFFICIENT OF FRICTION

DCOF ≥ 0,42

	Battiscopa Skirting		Scuretto Rabbeted riser		Gradino costa retta Straight nosed stair **		Gradino costa retta - Angolo SX / DX Straight-edge step - LH/RH corner **		Gradino Bordo Dritto Straight-edge step **		Gradino Bordo Dritto - Angolo SX / DX Straight-edge step - LH/RH corner **			
	120x60 48"x24" Nat. Ret.	120x60 48"x24" Lap. Ret.	6,5x120 2 1/2"x48" Nat. Ret.	6,5x120 2 1/2"x48" Lap. Ret.	20x120 8"x48" Nat. Ret.	20x120 8"x48" Lap. Ret.	33x120x3,2h 13"x48"x1 1/4" Nat. Ret.	33x120x3,2h 13"x48"x1 1/4" Lap. Ret.	33x120x3,2h 13"x48"x1 1/4" Nat. Ret.	33x120x3,2h 13"x48"x1 1/4" Lap. Ret.	30x120x4h 12"x48"x1 1/2" Nat. Ret.	30x120x4h 12"x48"x1 1/2" Lap. Ret.	30x120x4h 12"x48"x1 1/2" Nat. Ret.	30x120x4h 12"x48"x1 1/2" Lap. Ret.
COPACABANA EMPEROR	081130	081129	081210	081209	081250	081249	081290	081289	081380 SX 081330 DX	081379 SX 081329 DX	081420	081419	081490 SX 081450 DX	081489 SX 081449 DX
PREZZO PRICE	€ 46,00 m ²	€ 58,00 m ²	€ 8,00 PZ/PCE	€ 9,00 PZ/PCE	€ 26,00 PZ/PCE	€ 28,00 PZ/PCE	€ 140,00 PZ/PCE	€ 148,00 PZ/PCE	€ 164,00 PZ/PCE	€ 176,00 PZ/PCE	€ 106,00 PZ/PCE	€ 112,00 PZ/PCE	€ 134,00 PZ/PCE	€ 134,00 PZ/PCE
CODICE PREZZO PRICE CODE	M109	M125	P029	P033	P069	P073	P207	P215	P231	P243	P173	P179	P201	P201
IMBALLO cm h. PACKING cm h.	EPAL 80x120		Pallet 80x120		Pallet 80x120		Pallet 80x120		Pallet 80x120		Pallet 80x120		Pallet 80x120	
Tara / Tare	-		-		-		-		-		-		-	
	2		6		1		2		1		2		1	
m ² x	1,44		-		-		-		-		-		-	
Kg x	33,41		11,4		12		22		11		22		11	
	30		-		-		-		-		-		-	
m ² x	43,2		-		-		-		-		-		-	
Kg x	1.025		-		-		-		-		-		-	



**

PEZZI SPECIALI - A disposizione solo su richiesta. Tempi di consegna: 30gg.

TRIMS - Available upon request only. Delivery terms: 30 days.

PIÈCES SPECIALES - Disponible seulement sur requête. Délais de livraison: 30 jours.

FORMSTÜCKE - Verfügbar auf Anfrage. Lieferzeit: 30 Tage.

PIEZAS ESPECIALES - Disponible sólo bajo pedido. Plazo de entrega: 30 días.

СПЕЦИАЛНЫЕ ЭЛЕМЕНТЫ - Изготавливается только по специальной заявке. Срок поставки: 30 дней.

Mobile / Furniture
Statuario

Floor
Copacabana Emperor 120x60 (48"x24") Lap. Ret.

COPACABANA PRINCESS

LASTRE IN GRES PORCELLANATO PRESSATE A SECCO . DRY-PRESSED PORCELAIN STONEWARE SLABS .
DALLES EN GRÈS CÉRAMÉ PRESSÉES À SEC . TROCKENGEPRESSTE PLATTEN AUS FEINSTEINZEUG .
PLANCHAS EN GRÈS PORCELÁNICO PRENSADAS EN SECO . КЕРАМОГРАНИТНЫЕ ПЛИТЫ СУХОГО ПРЕССОВАНИЯ .
UNI EN 14411-ISO 13006 - Appendice C - Gruppo BIa - UGL

100% DESIGN
AND PRODUCTION
OF ITALY

V2
SHADE SPECTRUM
MODERATE

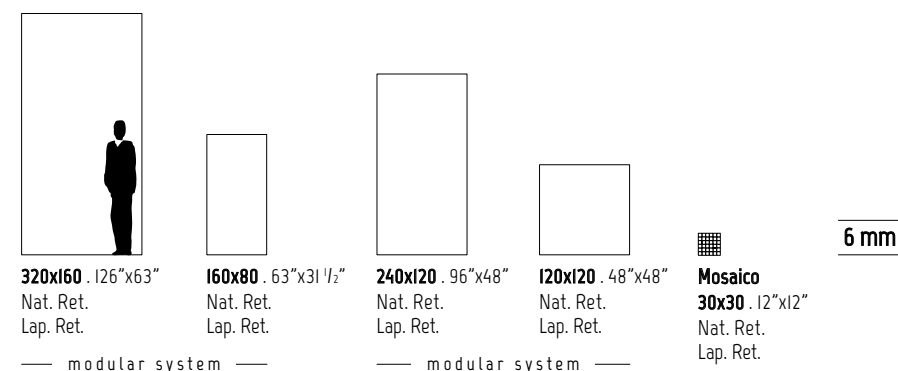

INDOOR

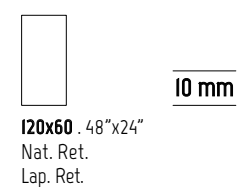

SVILUPPO GRAFICO PER FORMATO Pattern by size Développement graphique par format Grafischer Entwurf für Format Desarrollo gráfico por formato Варианты графики для каждого формата	320x160 6 mm	160x80 6 mm	240x120 6 mm	120x120 6 mm	120x60 10 mm
	7	28	13	26	26

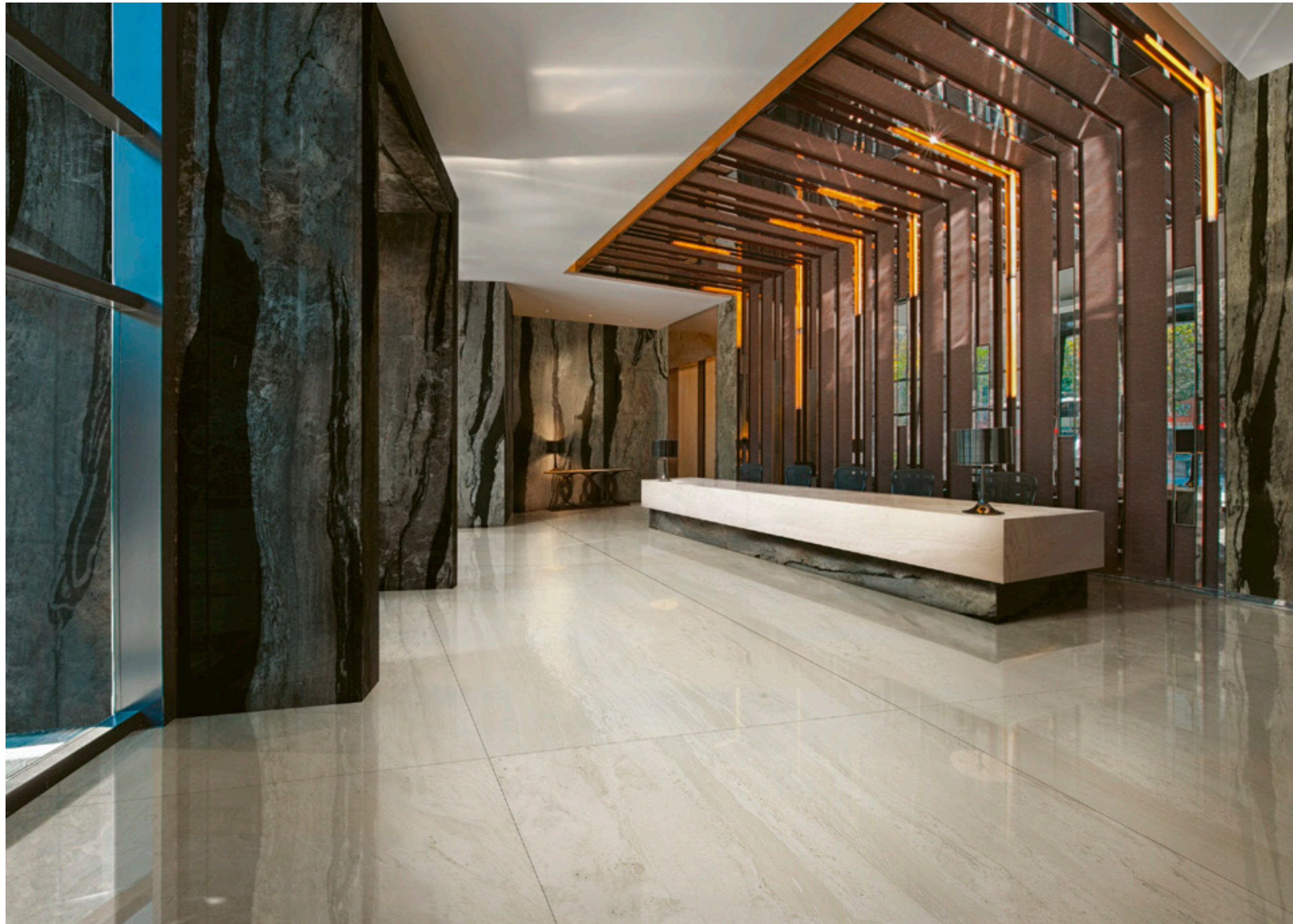

Wall
Copacabana Emperor 320x160 (126"x63") Lap. Ret.

Top e tavolo / Counter top and table
Copacabana Princess - Copacabana Emperor

Floor
Copacabana Princess 320x160 (126"x63") Lap. Ret.



320x160
SVILUPPO GRAFICO PER FORMATO - 7 Pattern by size
 7 Développement graphique par format - 7 Grafischer Entwurf für Format
 7 Desarrollo gráfico por formato - 7 Варианты графики для каждого формата

6 mm



081002
320x160 . 126"x63"
 Nat. Ret.

081001
320x160 . 126"x63"
 Lap. Ret.



081082
160x80 . 63"x31 1/2"
 Nat. Ret.

081081
160x80 . 63"x31 1/2"
 Lap. Ret.



081022
240x120 . 96"x48"
 Nat. Ret.

081021
240x120 . 96"x48"
 Lap. Ret.



081052
120x120 . 48"x48"
 Nat. Ret.

081051
120x120 . 48"x48"
 Lap. Ret.



Mosaico
081171
30x30 . 12"x12"
 Nat. Ret.

081172
30x30 . 12"x12"
 Lap. Ret.

modular system

modular system

INDOOR

10 mm

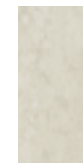

081122
120x60 . 48"x24"
 Nat. Ret.

081121
120x60 . 48"x24"
 Lap. Ret.

COPACABANA PRINCESS

6 mm

SOLO SUPERFICIE NATURALE
ONLY NATURAL SURFACE

ANSI A - 137.1: 2012
WET DYNAMIC COEFFICIENT OF FRICTION
DCOF ≥ 0,42

	modular system				modular system				Mosaico Mosaic		Battiscopa Skirting		Scuretto Rabbeted riser				Gradino costa retta Straight nosed stair **				Gradino costa retta - Angolo SX / DX Straight-edge step - LH/RH corner **				Gradino Bordo Dritto Straight-edge step **				Gradino Bordo Dritto - Angolo SX / DX Straight-edge step - LH/RH corner **							
	320x160 126"x63" Nat. Ret.	320x160 126"x63" Lap. Ret.	160x80 63"x31 1/2" Nat. Ret.	160x80 63"x31 1/2" Lap. Ret.	240x120 96"x48" Nat. Ret.	240x120 96"x48" Lap. Ret.	120x120 48"x48" Nat. Ret.	120x120 48"x48" Lap. Ret.	30x30 12"x12" Nat. Ret.	30x30 12"x12" Lap. Ret.	8x80 3"x31 1/2" Nat. Ret.	8x80 3"x31 1/2" Lap. Ret.	20x160 8"x63" Nat. Ret.	20x160 8"x63" Lap. Ret.	20x80 8"x31 1/2" Nat. Ret.	20x80 8"x31 1/2" Lap. Ret.	33x160x3,2h 13"x63"x1 1/4" Nat. Ret.	33x160x3,2h 13"x63"x1 1/4" Lap. Ret.	33x120x3,2h 13"x48"x1 1/4" Nat. Ret.	33x120x3,2h 13"x48"x1 1/4" Lap. Ret.	33x160x3,2h 13"x63"x1 1/4" Nat. Ret.	33x160x3,2h 13"x63"x1 1/4" Lap. Ret.	33x120x3,2h 13"x48"x1 1/4" Nat. Ret.	33x120x3,2h 13"x48"x1 1/4" Lap. Ret.	30x160x4h 12"x63"x1 1/2" Nat. Ret.	30x160x4h 12"x63"x1 1/2" Lap. Ret.	30x120x4h 12"x48"x1 1/2" Nat. Ret.	30x120x4h 12"x48"x1 1/2" Lap. Ret.	30x160x4h 12"x63"x1 1/2" Nat. Ret.	30x160x4h 12"x63"x1 1/2" Lap. Ret.	30x120x4h 12"x48"x1 1/2" Nat. Ret.	30x120x4h 12"x48"x1 1/2" Lap. Ret.				
COPACABANA PRINCESS	081002	081001	081082	081081	081022	081021	081052	081051	081071	081072	081212	081211	081222	081221	081252	081251	081262	081261	081272	081271	081352 SX 081302 DX	081351 SX 081301 DX	081362 SX 081312 DX	081361 SX 081311 DX	081392	081391	081402	081401	081462 SX 081422 DX	081461 SX 081421 DX	081472 SX 081432 DX	081471 SX 081431 DX				
PREZZO PRICE	€ 106,00 m ²	€ 130,00 m ²	€ 74,00 m ²	€ 102,00 m ²	€ 86,00 m ²	€ 108,00 m ²	€ 74,00 m ²	€ 102,00 m ²	€ 126,00 m ²	€ 168,00 m ²	€ 7,00 PZ/PCE	€ 11,00 PZ/PCE	€ 30,00 PZ/PCE	€ 42,00 PZ/PCE	€ 22,00 PZ/PCE	€ 30,00 PZ/PCE	€ 272,00 PZ/PCE	€ 312,00 PZ/PCE	€ 176,00 PZ/PCE	€ 198,00 PZ/PCE	€ 304,00 PZ/PCE	€ 344,00 PZ/PCE	€ 212,00 PZ/PCE	€ 232,00 PZ/PCE	€ 178,00 PZ/PCE	€ 200,00 PZ/PCE	€ 126,00 PZ/PCE	€ 134,00 PZ/PCE	€ 240,00 PZ/PCE	€ 276,00 PZ/PCE	€ 178,00 PZ/PCE	€ 190,00 PZ/PCE				
CODICE PREZZO PRICE CODE	M173	M197	M141	M169	M153	M175	M141	M169	M193	M235	P025	P039	P077	P101	P061	P077	P303	P323	P243	P265	P319	P339	P273	P283	P245	P267	P193	P201	P287	P305	P245	P257				
IMBALLO cm h. PACKING cm h.	345x175	330x75	168x97	264x136,6	250x75	143x123	250x75	EPAL 80x120	Pallet 80x120	Pallet 80x120	168x97	Pallet 80x120	168x97	Pallet 80x120	168x97	Pallet 80x120	168x97	Pallet 80x120	168x97	Pallet 80x120	168x97	Pallet 80x120	168x97	Pallet 80x120	168x97	Pallet 80x120	168x97	Pallet 80x120	168x97	Pallet 80x120	168x97	Pallet 80x120	168x97			
Tara / Tare	140,00	210,00	-	100,00	158,00	-	158,00	-	-	-	-	-	-	-	-	-	-	-	-	-	-	-	-	-	-	-	-	-	-	-	-	-	-			
N°	14	44	-	20	44	-	88	-	-	-	-	-	-	-	-	-	-	-	-	-	-	-	-	-	-	-	-	-	-	-	-	-	-			
m ² x	5,12	5,12	-	2,88	2,88	-	1,44	-	-	-	-	-	-	-	-	-	-	-	-	-	-	-	-	-	-	-	-	-	-	-	-	-	-	-		
Kg x	74,14	74,14	-	41,70	41,70	-	20,85	-	-	-	-	-	-	-	-	-	-	-	-	-	-	-	-	-	-	-	-	-	-	-	-	-	-	-	-	
m ² x	-	-	2	-	-	2	-	-	12	1	1	1	1	2	1	1	1	2	1	1	1	1	1	1	1	2	1	1	1	1	1	1	1	1	1	
Kg x	-	-	37,2	-	-	41,70	-	-	11,50	5	3	9	14	10	7	8,5	13,5	9,5	7	7	7	7	7	7	8,5	13,5	9,5	7	7	7	7	7	7	7		
m ² x	71,68	225,28	38,40	57,60	126,72	69,12	126,72	-	-	-	-	-	-	-	-	-	-	-	-	-	-	-	-	-	-	-	-	-	-	-	-	-	-	-	-	
Kg x	1.178	3.472	648	934	1.993	1.057	1.993	-	-	-	-	-	-	-	-	-	-	-	-	-	-	-	-	-	-	-	-	-	-	-	-	-	-	-	-	-



Cavalletto in legno
Wood A-Frame
Support en bois
Holzgestell
Caballete de madera
Деревянная подставка



Cassa
Crate
Caisse
Kiste
Caja
Ящик



Pallet speciale con sponde
Special pallet with sides
Palette spéciale avec bords
Spezial-Palette mit Wandungen
Palet especial con bordes
Специальный поддон с боковинами

** PEZZI SPECIALI - A disposizione solo su richiesta. Tempi di consegna: 30gg.
TRIMS - Available upon request only. Delivery terms: 30 days.
PIÈCES SPECIALES - Disponible seulement sur requête. Délais de livraison: 30 jours.
FORMSTÜCKE - Verfügbar auf Anfrage. Lieferzeit: 30 Tage.
PIEZAS ESPECIALES - Disponible sólo bajo pedido. Plazo de entrega: 30 días.
СПЕЦИАЛЬНЫЕ ЭЛЕМЕНТЫ - Изготавливается только по специальной заявке. Срок поставки: 30 дней.









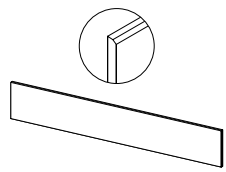
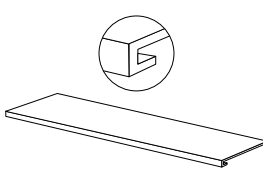
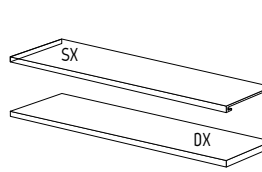
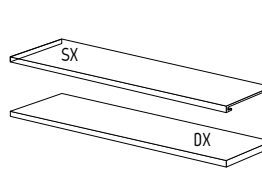
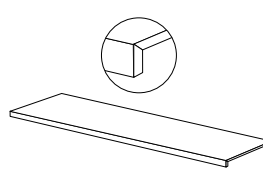
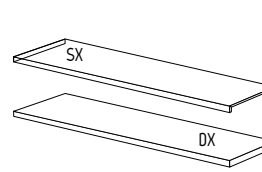
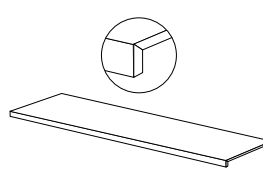
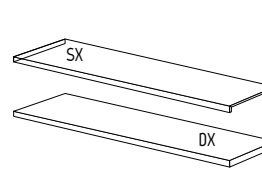
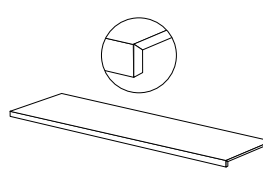
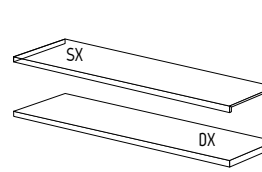
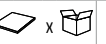

COPACABANA PRINCESS INDOOR

10 mm

SOLO SUPERFICIE NATURALE
ONLY NATURAL SURFACE

ANSI A - 137.1: 2012
WET DYNAMIC COEFFICIENT OF FRICTION

DCOF ≥ 0,42

	Battiscopa Skirting		Scuretto Rabbeted riser		Gradino costa retta Straight nosed stair **		Gradino costa retta - Angolo SX / DX Straight-edge step - LH/RH corner **		Gradino Bordo Dritto Straight-edge step **		Gradino Bordo Dritto - Angolo SX / DX Straight-edge step - LH/RH corner **			
														
	120x60 48"x24" Nat. Ret.	120x60 48"x24" Lap. Ret.	6,5x120 2 1/2"x48" Nat. Ret.	6,5x120 2 1/2"x48" Lap. Ret.	20x120 8"x48" Nat. Ret.	20x120 8"x48" Lap. Ret.	33x120x3,2h 13"x48"x1 1/4"h Nat. Ret.	33x120x3,2h 13"x48"x1 1/4"h Lap. Ret.	33x120x3,2h 13"x48"x1 1/4"h Nat. Ret.	33x120x3,2h 13"x48"x1 1/4"h Lap. Ret.	30x120x4h 12"x48"x1 1/2"h Nat. Ret.	30x120x4h 12"x48"x1 1/2"h Lap. Ret.	30x120x4h 12"x48"x1 1/2"h Nat. Ret.	30x120x4h 12"x48"x1 1/2"h Lap. Ret.
COPACABANA PRINCESS	081122	081121	081202	081201	081242	081241	081282	081281	081372 SX 081322 DX	081371 SX 081321 DX	081412	081411	081482 SX 081442 DX	081481 SX 081441 DX
PREZZO PRICE	€ 46,00 m ²	€ 58,00 m ²	€ 8,00 PZ/PCE	€ 9,00 PZ/PCE	€ 26,00 PZ/PCE	€ 28,00 PZ/PCE	€ 140,00 PZ/PCE	€ 148,00 PZ/PCE	€ 164,00 PZ/PCE	€ 176,00 PZ/PCE	€ 106,00 PZ/PCE	€ 112,00 PZ/PCE	€ 134,00 PZ/PCE	€ 134,00 PZ/PCE
CODICE PREZZO PRICE CODE	M109	M125	P029	P033	P069	P073	P207	P215	P231	P243	P173	P179	P201	P201
EPAL	80x120		Pallet 80x120		Pallet 80x120		Pallet 80x120		Pallet 80x120		Pallet 80x120		Pallet 80x120	
IMBALLO cm h. PACKING cm h.	-		-		-		-		-		-		-	
Tara / Tare	20		-		-		-		-		-		-	
 x 	2		6		1		2		1		2		1	
m ² x 	1,44		-		-		-		-		-		-	
Kg x 	33,41		11,4		12		22		11		22		11	
 x 	30		-		-		-		-		-		-	
m ² x 	43,2		-		-		-		-		-		-	
Kg x 	1.025		-		-		-		-		-		-	

**

PEZZI SPECIALI - A disposizione solo su richiesta. Tempi di consegna: 30gg.

TRIMS - Available upon request only. Delivery terms: 30 days.

PIÈCES SPECIALES - Disponible seulement sur requête. Délais de livraison: 30 jours.

FORMSTÜCKE - Verfügbar auf Anfrage. Lieferzeit: 30 Tage.

PIEZAS ESPECIALES - Disponible sólo bajo pedido. Plazo de entrega: 30 días.

СПЕЦИАЛНЫЕ ЭЛЕМЕНТЫ - Изготавливается только по специальной заявке. Срок поставки: 30 дней.



Wall
Copacabana Princess 320x160 (126"x63") Lap. Ret.

Floor
Copacabana Emperor 320x160 (126"x63") Lap. Ret.

CREMA MARFIL

LASTRE IN GRES PORCELLANATO PRESSATE A SECCO . DRY-PRESSED PORCELAIN STONEWARE SLABS .
 DALLES EN GRÈS CÉRAMÉ PRESSÉES À SEC . TROCKENGEPRESSTE PLATTEN AUS FEINSTEINZEUG .
 PLANCHAS EN GRÈS PORCELÁNICO PRENSADAS EN SECO . КЕРАМОГРАНИТНЫЕ ПЛИТЫ СУХОГО ПРЕССОВАНИЯ .
 UNI EN 14411-ISO 13006 - Appendice C - Gruppo BIa - UGL

100% DESIGN
AND PRODUCTION
OF ITALY

V2
SHADE SPECTRUM
MODERATE

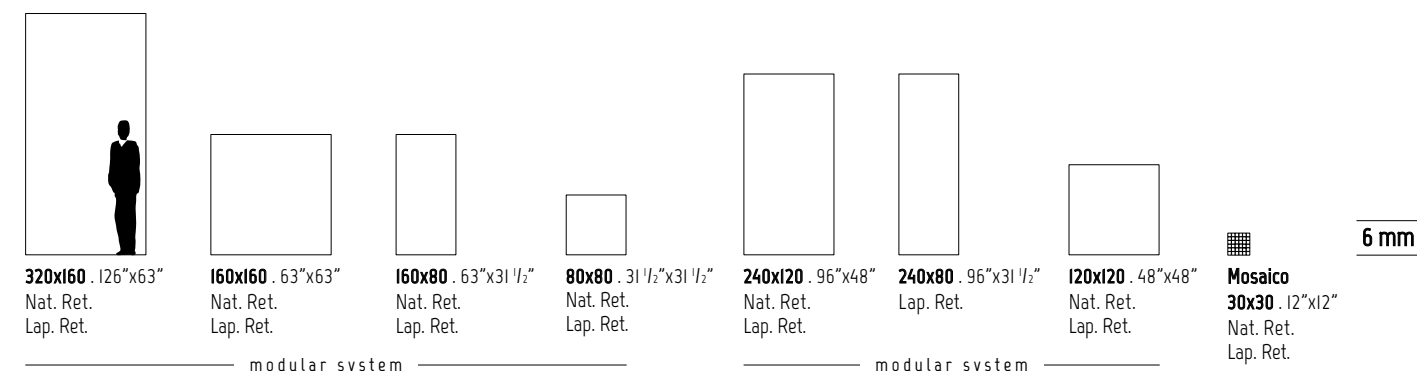

INDOOR

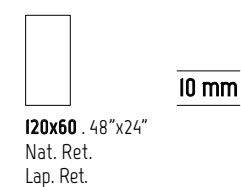

SVILUPPO GRAFICO PER FORMATO Pattern by size Développement graphique par format Grafischer Entwurf für Format Desarrollo gráfico por formato Варианты графики для каждого формата	320x160 6 mm	160x160 6 mm	160x80 6 mm	80x80 6 mm	240x120 6 mm	240x80 6 mm	120x120 6 mm	120x60 10 mm
	8	16	32	64	11	22	22	25



Wall
Crema Marfil Lap. Ret.

Floor
Crema Marfil 120x120 (48"x48") Lap. Ret.



6 mm



083010
320x160 . 126"x63"
Nat. Ret.

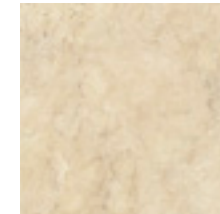

083030
160x160 . 63"x63"
Nat. Ret.

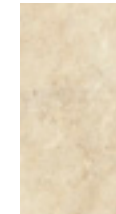

083050
160x80 . 63"x31 1/2"
Nat. Ret.

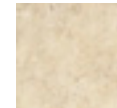

083060
80x80 . 31 1/2"x31 1/2"
Nat. Ret.

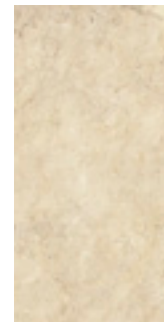

083020
240x120 . 96"x48"
Nat. Ret.

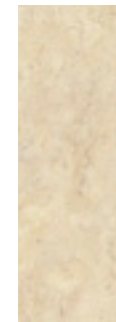

083557
240x80 . 96"x31 1/2"
Lap. Ret.

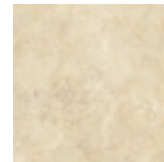

083040
120x120 . 48"x48"
Nat. Ret.



Mosaico
083198
30x30 . 12"x12"
Nat. Ret.

083199
30x30 . 12"x12"
Lap. Ret.

modular system

modular system

INDOOR

10 mm

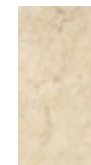

083070
120x60 . 48"x24"
Nat. Ret.













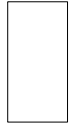
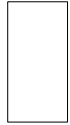

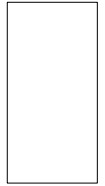







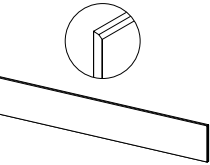
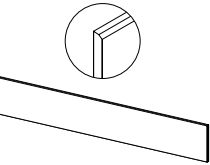
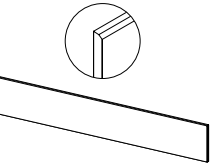
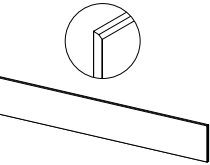



















083069
120x60 . 48"x24"
Lap. Ret.

320x160

SVILUPPO GRAFICO PER FORMATO - 8 Pattern by size
8 Développement graphique par format - 8 Grafischer Entwurf für Format
8 Desarrollo gráfico por formato - 8 Варианты графики для каждого формата

CREMA MARFIL

6 mm

		modular system								modular system								Mosaico Mosaic		Battiscopa Skirting		Scuretto Rabbeted riser			
																									
		320x160 126"x63" Nat. Ret.	320x160 126"x63" Lap. Ret.	160x160 63"x63" Nat. Ret.	160x160 63"x63" Lap. Ret.	160x80 63"x31 1/2" Nat. Ret.	160x80 63"x31 1/2" Lap. Ret.	80x80 31 1/2"x31 1/2" Nat. Ret.	80x80 31 1/2"x31 1/2" Lap. Ret.	240x120 96"x48" Nat. Ret.	240x120 96"x48" Lap. Ret.	240x80 96"x31 1/2" Lap. Ret.	120x120 48"x48" Nat. Ret.	120x120 48"x48" Lap. Ret.	30x30 12"x12" Nat. Ret.	30x30 12"x12" Lap. Ret.	8x80 3"x31 1/2" Nat. Ret.	8x80 3"x31 1/2" Lap. Ret.	20x160 8"x63" Nat. Ret.	20x160 8"x63" Lap. Ret.	20x80 8"x31 1/2" Nat. Ret.	20x80 8"x31 1/2" Lap. Ret.			
CREMA MARFIL		083010	083009	083030	083029	083050	083049	083060	083059	083020	083019	083557	083040	083039	083198	083199	083210	083209	083228	083229	083238	083239			
PREZZO PRICE		€ 106,00 m ²	€ 130,00 m ²	€ 94,00 m ²	€ 120,00 m ²	€ 74,00 m ²	€ 102,00 m ²	€ 62,00 m ²	€ 76,00 m ²	€ 86,00 m ²	€ 108,00 m ²	€ 108,00 m ²	€ 74,00 m ²	€ 102,00 m ²	€ 126,00 m ²	€ 168,00 m ²	€ 7,00 PZ/PCE	€ 8,00 PZ/PCE	€ 30,00 PZ/PCE	€ 42,00 PZ/PCE	€ 22,00 PZ/PCE	€ 30,00 PZ/PCE			
CODICE PREZZO PRICE CODE		M173	M197	M161	M187	M141	M169	M129	M143	M153	M175	M175	M141	M169	M193	M235	P025	P029	P077	P101	P061	P077			
IMBALLO cm h. PACKING cm h.							EPAL 80x120								EPAL 80x120		Pallet 80x120			Pallet 80x120					
Tara / Tare		37	193,5	40,4	193,5	40,9	-	40	153,5	47	153,5	64,7	153,5	-	-	-	-	40,9	-	-	-				
N°		14	44	24	88	-	-	20	44	30	44	-	88	-	-	-	-	-	-	-	-				
m ² x		5,12	5,12	2,56	2,56	-	-	2,88	2,88	1,92	1,92	-	1,44	-	-	-	-	-	-	-	-				
Kg x		74,14	74,14	37,07	37,07	-	-	41,70	41,70	27,80	27,80	-	20,85	-	-	-	-	-	-	-	-				
		-	-	-	-	2	3	-	-	-	-	2	-	-	-	-	12	1	1	-					
m ² x		-	-	-	-	2,56	1,92	-	-	-	-	2,88	-	-	-	-	0,77	-	-	-					
Kg x		-	-	-	-	37,2	27,90	-	-	-	-	41,70	-	-	-	-	11,50	5	3	-					
		-	-	-	-	15	40	-	-	-	-	24	-	-	-	-	-	-	-	-					
m ² x		71,68	225,28	61,44	225,28	38,40	76,80	57,60	126,72	57,60	84,48	69,12	126,72	-	-	-	-	-	-	-					
Kg x		1.178	3.472	962	3.472	648	1.141	934	1.993	912	1.381	1.057	1.993	-	-	-	-	-	-	-					

SOLO SUPERFICIE NATURALE ONLY NATURAL SURFACE
ANSI A - 137.1: 2012 WET DYNAMIC COEFFICIENT OF FRICTION DCOF ≥ 0,42



Cavalletto in legno
Wood A-Frame
Support en bois
Holzgestell
Caballete de madera
Деревянная подставка



Cassa
Crate
Caisse
Kiste
Caja
Ящик



Pallet speciale con sponde
Special pallet with sides
Palette spéciale avec bords
Spezial-Palette mit Wandungen
Palet especial con bordes
Специальный поддон с боковинами

CREMA MARFIL

6 mm

SOLO SUPERFICIE NATURALE
ONLY NATURAL SURFACE
ANSI A - 137.1: 2012
WET DYNAMIC COEFFICIENT OF FRICTION
DCOF ≥ 0,42

	Gradino costa retta Straight nosed stair **						Gradino costa retta - Angolo SX / DX Straight-edge step - LH/RH corner **						Gradino Bordo Dritto Straight-edge step **				Gradino Bordo Dritto - Angolo SX / DX Straight-edge step - LH/RH corner **							
	33x160x3,2h 13"x63"x1 1/4"h Nat. Ret.	33x160x3,2h 13"x63"x1 1/4"h Lap. Ret.	33x120x3,2h 13"x48"x1 1/4"h Nat. Ret.	33x120x3,2h 13"x48"x1 1/4"h Lap. Ret.	33x80x3,2h 13"x31 1/2"x1 1/4"h Nat. Ret.	33x80x3,2h 13"x31 1/2"x1 1/4"h Lap. Ret.	33x160x3,2h 13"x63"x1 1/4"h Nat. Ret.	33x160x3,2h 13"x63"x1 1/4"h Lap. Ret.	33x120x3,2h 13"x48"x1 1/4"h Nat. Ret.	33x120x3,2h 13"x48"x1 1/4"h Lap. Ret.	33x80x3,2h 13"x31 1/2"x1 1/4"h Nat. Ret.	33x80x3,2h 13"x31 1/2"x1 1/4"h Lap. Ret.	30x160x4h 12"x63"x1 1/2"h Nat. Ret.	30x160x4h 12"x63"x1 1/2"h Lap. Ret.	30x120x4h 12"x48"x1 1/2"h Nat. Ret.	30x120x4h 12"x48"x1 1/2"h Lap. Ret.	30x80x4h 12"x31 1/2"x1 1/2"h Nat. Ret.	30x80x4h 12"x31 1/2"x1 1/2"h Lap. Ret.	30x160x4h 12"x63"x1 1/2"h Nat. Ret.	30x160x4h 12"x63"x1 1/2"h Lap. Ret.	30x120x4h 12"x48"x1 1/2"h Nat. Ret.	30x120x4h 12"x48"x1 1/2"h Lap. Ret.	30x80x4h 12"x31 1/2"x1 1/2"h Nat. Ret.	30x80x4h 12"x31 1/2"x1 1/2"h Lap. Ret.
CREMA MARFIL	083258	083259	083268	083269	083278	083279	083338 SX 083298 DX	083339 SX 083299 DX	083348 SX 083308 DX	083349 SX 083309 DX	083358 SX 083318 DX	083359 SX 083319 DX	083391	083379	083390	083639	083398	083399	083458 SX 083418 DX	083459 SX 083419 DX	083468 SX 083428 DX	083469 SX 083429 DX	083478 SX 083438 DX	083479 SX 083439 DX
PREZZO PRICE	€ 272,00 PZ/PCE	€ 312,00 PZ/PCE	€ 176,00 PZ/PCE	€ 198,00 PZ/PCE	€ 100,00 PZ/PCE	€ 108,00 PZ/PCE	€ 304,00 PZ/PCE	€ 344,00 PZ/PCE	€ 212,00 PZ/PCE	€ 232,00 PZ/PCE	€ 136,00 PZ/PCE	€ 148,00 PZ/PCE	€ 178,00 PZ/PCE	€ 200,00 PZ/PCE	€ 126,00 PZ/PCE	€ 134,00 PZ/PCE	€ 68,00 PZ/PCE	€ 76,00 PZ/PCE	€ 240,00 PZ/PCE	€ 276,00 PZ/PCE	€ 178,00 PZ/PCE	€ 190,00 PZ/PCE	€ 116,00 PZ/PCE	€ 130,00 PZ/PCE
CODICE PREZZO PRICE CODE	P303	P323	P243	P265	P167	P175	P319	P339	P273	P283	P203	P215	P245	P267	P193	P201	P135	P143	P287	P305	P245	P257	P183	P197
IMBALLO cm h. PACKING cm h.	168x97		Pallet 80x120		Pallet 80x120		168x97		Pallet 80x120		Pallet 80x120		168x97		Pallet 80x120		Pallet 80x120		168x97		Pallet 80x120		Pallet 80x120	
Tara / Tare	-	-	-	-	-	-	-	-	-	-	-	-	-	-	-	-	-	-	-	-	-	-	-	-
	1	2	2	1	1	1	1	1	1	1	1	1	1	2	2	2	1	1	1	1	1	1	1	1
	-	-	-	-	-	-	-	-	-	-	-	-	-	-	-	-	-	-	-	-	-	-	-	-
	9	14	10	10	7	6	8,5	13,5	9	9,5	7	5												
	-	-	-	-	-	-	-	-	-	-	-	-	-	-	-	-	-	-	-	-	-	-	-	-
	-	-	-	-	-	-	-	-	-	-	-	-	-	-	-	-	-	-	-	-	-	-	-	-



Pallet speciale con sponde
Special pallet with sides
Palette spéciale avec bords
Spezial-Palette mit Wandungen
Palet especial con bordes
Специальный поддон с боковинами





** PEZZI SPECIALI - A disposizione solo su richiesta. Tempi di consegna: 30gg.
TRIMS - Available upon request only. Delivery terms: 30 days.
PIÈCES SPECIALES - Disponible seulement sur requête. Délais de livraison: 30 jours.
FORMSTÜCKE - Verfügbar auf Anfrage. Lieferzeit: 30 Tage.
PIEZAS ESPECIALES - Disponible sólo bajo pedido. Plazo de entrega: 30 días.
СПЕЦИАЛЬНЫЕ ЭЛЕМЕНТЫ - Изготавливается только по специальной заявке. Срок поставки: 30 дней.

CREMA MARFIL INDOOR

10 mm

SOLO SUPERFICIE NATURALE
ONLY NATURAL SURFACE

ANSI A - 137.1: 2012
WET DYNAMIC COEFFICIENT OF FRICTION | DCOF ≥ 0,42

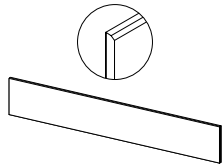
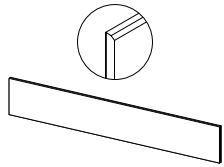
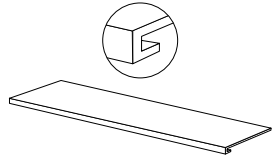
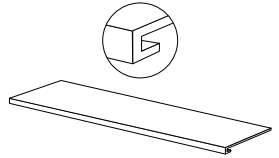
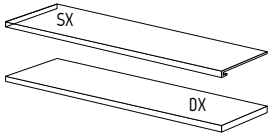
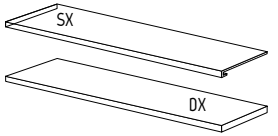
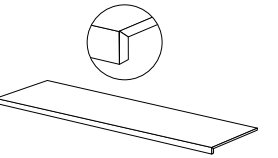
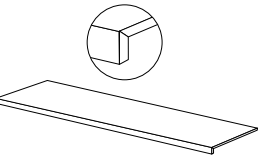
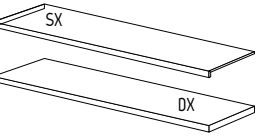
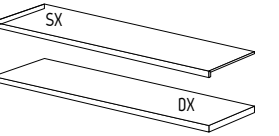
	Battiscopa Skirting		Scuretto Rabbeted riser		Gradino costa retta Straight nosed stair **		Gradino costa retta - Angolo SX / DX Straight-edge step - LH/RH corner **		Gradino Bordo Dritto Straight-edge step **		Gradino Bordo Dritto - Angolo SX / DX Straight-edge step - LH/RH corner **			
	 120x60 48"x24" Nat. Ret.	 120x60 48"x24" Lap. Ret.	 6,5x120 2 1/2"x48" Nat. Ret.	 6,5x120 2 1/2"x48" Lap. Ret.	 20x120 8"x48" Nat. Ret.	 20x120 8"x48" Lap. Ret.	 33x120x3,2h 13"x48"x1 1/4"h Nat. Ret.	 33x120x3,2h 13"x48"x1 1/4"h Lap. Ret.	 33x120x3,2h 13"x48"x1 1/4"h Nat. Ret.	 33x120x3,2h 13"x48"x1 1/4"h Lap. Ret.	 30x120x4h 12"x48"x1 1/2"h Nat. Ret.	 30x120x4h 12"x48"x1 1/2"h Lap. Ret.	 30x120x4h 12"x48"x1 1/2"h Nat. Ret.	 30x120x4h 12"x48"x1 1/2"h Lap. Ret.
CREMA MARFIL	083070	083069	083220	083219	083248	083249	083290	083289	083368 SX 083328 DX	083369 SX 083329 DX	083408	083409	083488 SX 083448 DX	083489 SX 083449 DX
PREZZO PRICE	€ 46,00 m ²	€ 58,00 m ²	€ 8,00 PZ/PCE	€ 9,00 PZ/PCE	€ 26,00 PZ/PCE	€ 28,00 PZ/PCE	€ 140,00 PZ/PCE	€ 148,00 PZ/PCE	€ 164,00 PZ/PCE	€ 176,00 PZ/PCE	€ 106,00 PZ/PCE	€ 112,00 PZ/PCE	€ 134,00 PZ/PCE	€ 134,00 PZ/PCE
CODICE PREZZO PRICE CODE	M109	M125	P029	P033	P069	P073	P207	P215	P231	P243	P173	P179	P201	P201
IMBALLO cm h. PACKING cm h.	EPAL 80x120	EPAL 80x120	Pallet 80x120	Pallet 80x120	Pallet 80x120	Pallet 80x120	Pallet 80x120	Pallet 80x120	Pallet 80x120	Pallet 80x120	Pallet 80x120	Pallet 80x120	Pallet 80x120	Pallet 80x120
Tara / Tare	20	20	-	-	-	-	-	-	-	-	-	-	-	-
Icona x	2	2	6	6	1	1	2	2	1	1	2	2	1	1
m ² x	1,44	1,44	-	-	-	-	-	-	-	-	-	-	-	-
Kg x	33,41	33,41	11,4	11,4	12	12	22	22	11	11	22	22	11	11
Icona x	30	30	-	-	-	-	-	-	-	-	-	-	-	-
m ² x	43,2	43,2	-	-	-	-	-	-	-	-	-	-	-	-
Kg x	1.025	1.025	-	-	-	-	-	-	-	-	-	-	-	-

**

PEZZI SPECIALI - A disposizione solo su richiesta. Tempi di consegna: 30gg.

TRIMS - Available upon request only. Delivery terms: 30 days.

PIÈCES SPECIALES - Disponible seulement sur requête. Délais de livraison: 30 jours.

FORMSTÜCKE - Verfügbar auf Anfrage. Lieferzeit: 30 Tage.

PIEZAS ESPECIALES - Disponible sólo bajo pedido. Plazo de entrega: 30 días.

СПЕЦИАЛЬНЫЕ ЭЛЕМЕНТЫ - Изготавливается только по специальной заявке. Срок поставки: 30 дней.

C-STONE

LASTRE IN GRES PORCELLANATO PRESSATE A SECCO . DRY-PRESSED PORCELAIN STONEWARE SLABS .
 DALLES EN GRÈS CÉRAMÉ PRESSÉES À SEC . TROCKENGEPRESSTE PLATTEN AUS FEINSTEINZEUG .
 PLANCHAS EN GRÉS PORCELÁNICO PRENSADAS EN SECO . КЕРАМОГРАНИТНЫЕ ПЛИТЫ СУХОГО ПРЕССОВАНИЯ .
 UNI EN 14411-ISO 13006 - Appendice C - Gruppo BIa - UGL

100% DESIGN
AND PRODUCTION
OF ITALY

V2
SHADE SPECTRUM
MODERATE

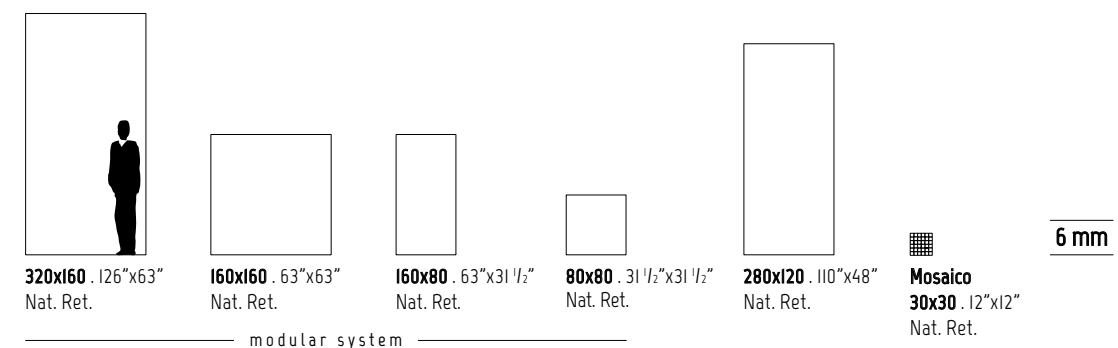

SVILUPPO GRAFICO PER FORMATO
 Pattern by size
 Développement graphique par format
 Grafischer Entwurf für Format
 Desarrollo gráfico por formato
 Варианты графики для каждого формата

	320x160 6 mm	160x160 6 mm	160x80 6 mm	80x80 6 mm	280x120 6 mm
	7	14	28	56	9

Floor
C-Stone 320x160 (126"x63") Nat. Ret.



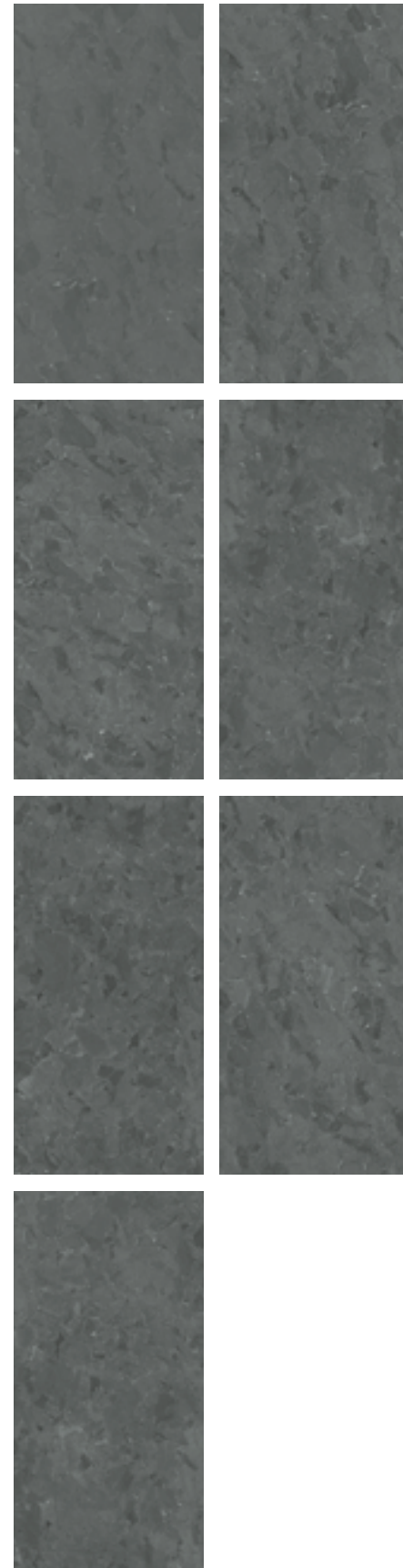

320x160
 SVILUPPO GRAFICO PER FORMATO - 7 Pattern by size
 7 Développement graphique par format - 7 Grafischer Entwurf für Format
 7 Desarrollo gráfico por formato - 7 Варианты графики для каждого формата

6 mm



I42001
320x160 . 126"x63"
 Nat. Ret.

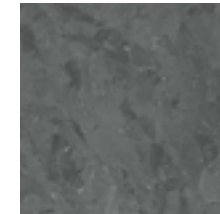

I42041
160x160 . 63"x63"
 Nat. Ret.

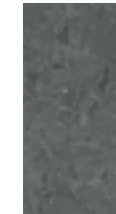

I42081
160x80 . 63"x31 1/2"
 Nat. Ret.



I42101
80x80 . 31 1/2"x31 1/2"
 Nat. Ret.

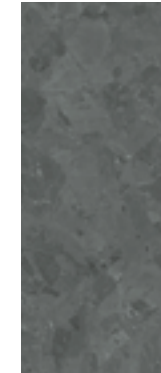

I42021
280x120 . 110"x48"
 Nat. Ret.



Mosaico
I42301
30x30 . 12"x12"
 Nat. Ret.

modular system

C-STONE

6 mm

modular system

ANSI A - 137.1: 2012
WET DYNAMIC COEFFICIENT OF FRICTION | DCOF ≥ 0,42

	modular system				Mosaico Mosaic	Battiscopa Skirting	Scoretto Rabbeted riser	Gradino costa retta Straight nosed stair **	Gradino costa retta - Angolo SX / DX Straight-edge step - LH/RH corner **	Gradino Bordo Dritto Straight-edge step **	Gradino Bordo Dritto - Angolo SX / DX Straight-edge step - LH/RH corner **									
	320x160 126"x63" Nat. Ret.	160x160 63"x63" Nat. Ret.	160x80 63"x31 1/2" Nat. Ret.	80x80 31 1/2"x31 1/2" Nat. Ret.	280x120 110"x48" Nat. Ret.	30x30 12"x12" Nat. Ret.	8x80 3"x31 1/2" Nat. Ret.	20x160 8"x63" Nat. Ret.	20x80 8"x31 1/2" Nat. Ret.	33x160x3,2h 13"x63"x1 1/4" Nat. Ret.	33x80x3,2h 13"x31 1/2"x1 1/4" Nat. Ret.	33x160x3,2h 13"x63"x1 1/4" Nat. Ret.	33x80x3,2h 13"x31 1/2"x1 1/4" Nat. Ret.	30x160x4h 12"x63"x1 1/2" Nat. Ret.	30x80x4h 12"x31 1/2"x1 1/2" Nat. Ret.	30x160x4h 12"x63"x1 1/2" Nat. Ret.	30x80x4h 12"x31 1/2"x1 1/2" Nat. Ret.			
C-STONE	I42001	I42041	I42081	I42101	I42021	I42301	I42201	I42251	I42261	I42401	I42404	I42403 SX I42402 DX	I42406 SX I42405 DX	I42407	I42410	I42409 SX I42408 DX	I42412 SX I42411 DX			
PREZZO PRICE	€ 106,00 m ²	€ 94,00 m ²	€ 74,00 m ²	€ 76,00 m ²	€ 86,00 m ²	€ 126,00 m ²	€ 7,00 PZ/PCE	€ 30,00 PZ/PCE	€ 22,00 PZ/PCE	€ 272,00 PZ/PCE	€ 100,00 PZ/PCE	€ 304,00 PZ/PCE	€ 136,00 PZ/PCE	€ 178,00 PZ/PCE	€ 68,00 PZ/PCE	€ 240,00 PZ/PCE	€ 116,00 PZ/PCE			
CODICE PREZZO PRICE CODE	M173	M161	M141	M143	M153	M193	P025	P077	P061	P303	P167	P319	P203	P245	P135	P287	P183			
IMBALLO cm h. PACKING cm h.	345x175	330x75	182,6x173,6	330x75	168x97	EPAL 80x120	302x136	330x75	EPAL 80x120	Pallet 80x120	168x97	Pallet 80x120	168x97	Pallet 80x120	168x97	Pallet 80x120	168x97	Pallet 80x120		
Tara / Tare	140,00	210,00	71,80	210,00	-	20	108,00	210,00	-	-	-	-	-	-	-	-	-	-		
N°	14	44	24	88	-	-	20	44	-	-	-	-	-	-	-	-	-	-		
m ² x	5,12	5,12	2,56	2,56	-	-	3,36	3,36	-	-	-	-	-	-	-	-	-	-		
Kg x	74,14	74,14	37,07	37,07	-	-	48,65	48,65	-	-	-	-	-	-	-	-	-	-		
x	-	-	-	-	2	3	-	-	-	12	1	1	1	2	1	1	1	2	1	1
m ² x	-	-	-	-	2,56	1,92	-	-	-	0,77	-	-	-	-	-	-	-	-	-	
Kg x	-	-	-	-	37,2	27,90	-	-	-	11,50	5	3	9	10	10	6	8,5	9	9,5	5
x	-	-	-	-	15	40	-	-	-	-	-	-	-	-	-	-	-	-	-	-
m ² x	71,68	225,28	61,44	225,28	38,40	76,80	67,2	147,84	-	-	-	-	-	-	-	-	-	-	-	
Kg x	1.178	3.472	962	3.472	648	1.141	1.081	2.350	-	-	-	-	-	-	-	-	-	-	-	



Cavalletto in legno
Wood A-Frame
Support en bois
Holzgestell
Caballette de madera
Деревянная подставка



Cassa
Crate
Caisse
Kiste
Caja
Ящик



Pallet speciale con sponde
Special pallet with sides
Palette spéciale avec bords
Spezial-Palette mit Wandungen
Palet especial con bordes
Специальный поддон с боковинами

** PEZZI SPECIALI - A disposizione solo su richiesta. Tempi di consegna: 30gg.
TRIMS - Available upon request only. Delivery terms: 30 days.
PIÈCES SPECIALES - Disponible seulement sur requête. Délais de livraison: 30 jours.
FORMSTÜCKE - Verfügbar auf Anfrage. Lieferzeit: 30 Tage.
PIEZAS ESPECIALES - Disponible sólo bajo pedido. Plazo de entrega: 30 días.
СПЕЦИАЛЬНЫЕ ЭЛЕМЕНТЫ - Изготавливается только по специальной заявке. Срок поставки: 30 дней.

LASA

LASTRE IN GRES PORCELLANATO PRESSATE A SECCO . DRY-PRESSED PORCELAIN STONWARE SLABS .
 DALLES EN GRÈS CÉRAMÉ PRESSÉES À SEC . TROCKENGEPRESSTE PLATTEN AUS FEINSTEINZEUG .
 PLANCHAS EN GRÉS PORCELÁNICO PRENSADAS EN SECO . КЕРАМОГРАНИТНЫЕ ПЛИТЫ СУХОГО ПРЕССОВАНИЯ .
 UNI EN 14411-ISO 13006 - Appendice C - Gruppo BIa - UCL

100% DESIGN
AND PRODUCTION
OF ITALY

V2
SHADE SPECTRUM
MODERATE

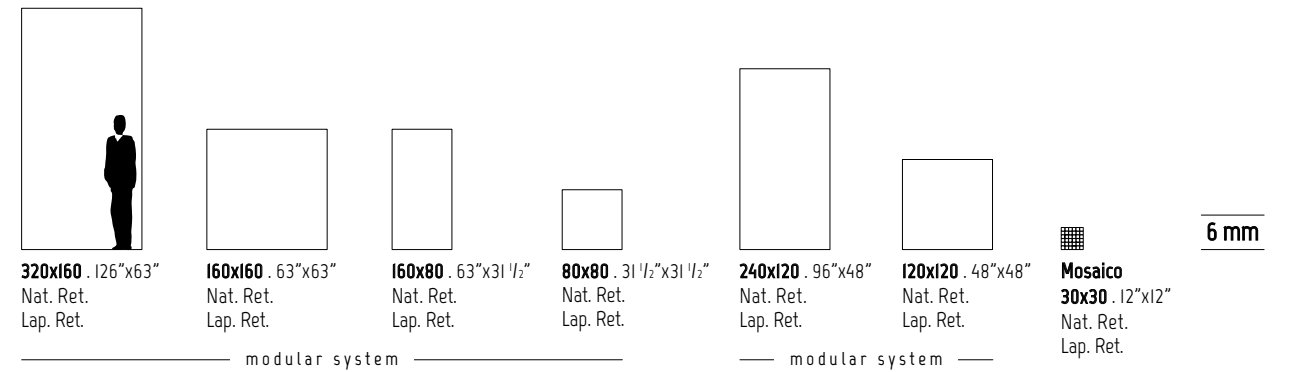

INDOOR

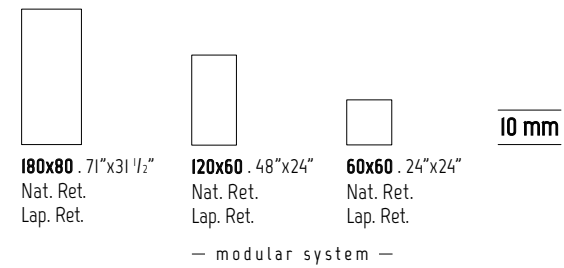

SVILUPPO GRAFICO PER FORMATO Pattern by size Développement graphique par format Grafischer Entwurf für Format Desarrollo gráfico por formato Варианты графики для каждого формата	320x160 6 mm	160x160 6 mm	160x80 6 mm	80x80 6 mm	240x120 6 mm	120x120 6 mm	180x80 10 mm	120x60 10 mm	60x60 10 mm
	7	14	28	56	11	22	14	21	42

Top / Counter top
Collection Azul Macauba Lap. Ret.



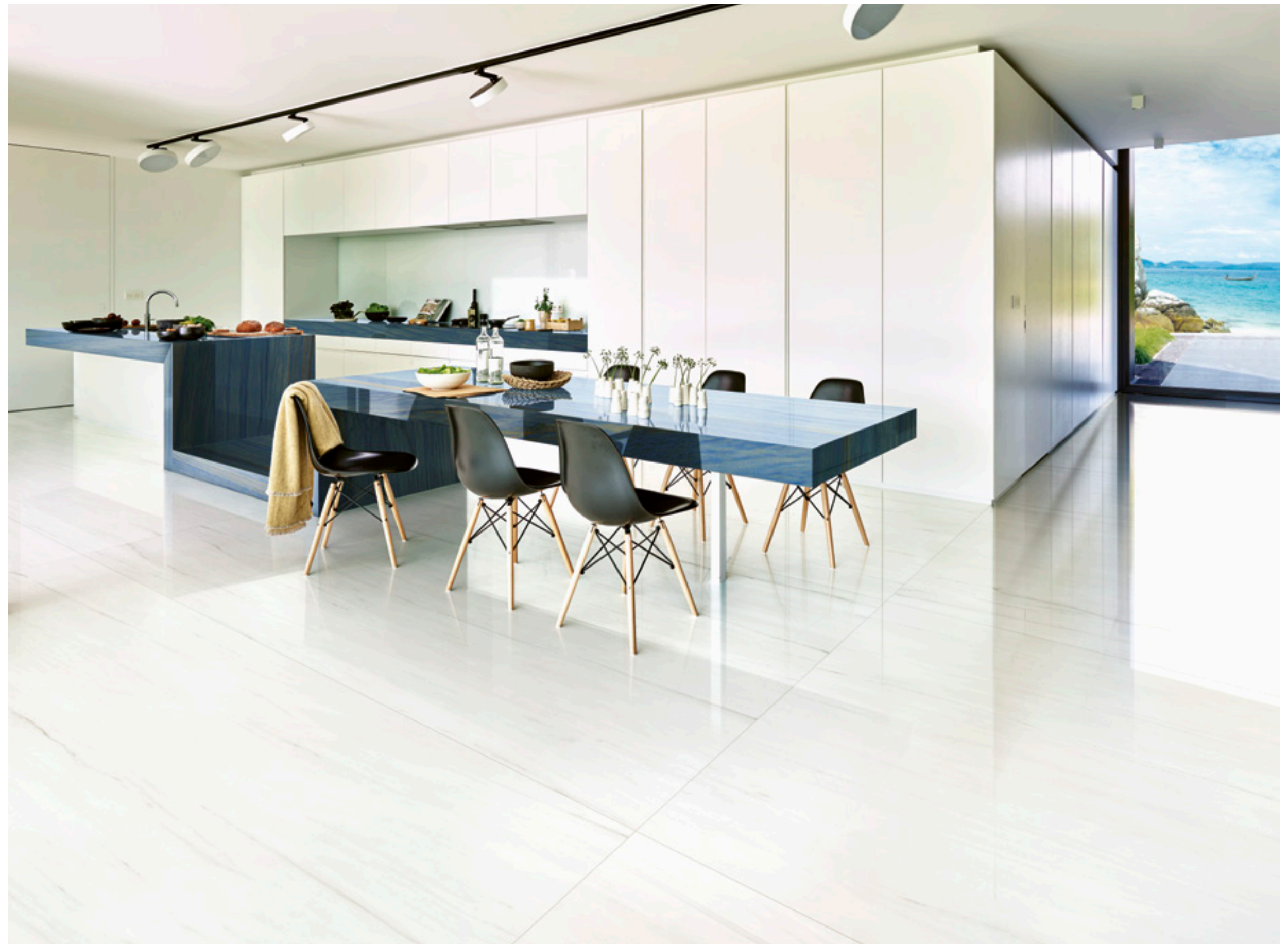



Floor
Lasa 320x160 (126"x63") Lap. Ret.



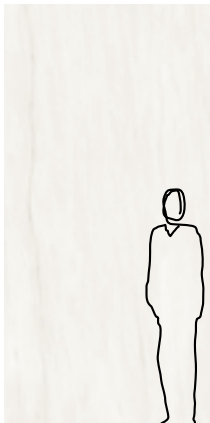

320x160
SVILUPPO GRAFICO PER FORMATO - 7 Pattern by size
 7 Développement graphique par format - 7 Grafischer Entwurf für Format
 7 Desarrollo gráfico por formato - 7 Варианты графики для каждого формата

6 mm

						
087004 320x160 . 126"x63" Nat. Ret.	087044 160x160 . 63"x63" Nat. Ret.	087084 160x80 . 63"x31 1/2" Nat. Ret.	087104 80x80 . 31 1/2"x31 1/2" Nat. Ret.	087024 240x120 . 96"x48" Nat. Ret.	087064 120x120 . 48"x48" Nat. Ret.	Mosaico 087194 30x30 . 12"x12" Nat. Ret.
087003 320x160 . 126"x63" Lap. Ret.	087043 160x160 . 63"x63" Lap. Ret.	087083 160x80 . 63"x31 1/2" Lap. Ret.	087103 80x80 . 31 1/2"x31 1/2" Lap. Ret.	087023 240x120 . 96"x48" Lap. Ret.	087063 120x120 . 48"x48" Lap. Ret.	087193 30x30 . 12"x12" Lap. Ret.
— modular system —				— modular system —		

INDOOR











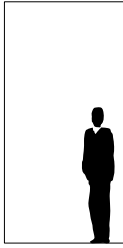

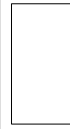

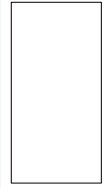



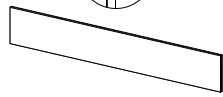







10 mm

		
087615 180x80 . 71"x31 1/2" Nat. Ret.	087124 120x60 . 48"x24" Nat. Ret.	087144 60x60 . 24"x24" Nat. Ret.
087612 180x80 . 71"x31 1/2" Lap. Ret.	087123 120x60 . 48"x24" Lap. Ret.	087143 60x60 . 24"x24" Lap. Ret.
— modular system —		

6 mm

SOLO SUPERFICIE NATURALE
ONLY NATURAL SURFACE

ANSI A - 137.1: 2012
WET DYNAMIC COEFFICIENT OF FRICTION | DCOF ≥ 0,42

	modular system								modular system				Mosaico Mosaic	Battiscopa Skirting	Scuretto Rabbeted riser					
																				
	320x160 126"x63" Nat. Ret.	320x160 126"x63" Lap. Ret.	160x160 63"x63" Nat. Ret.	160x160 63"x63" Lap. Ret.	160x80 63"x31 1/2" Nat. Ret.	160x80 63"x31 1/2" Lap. Ret.	80x80 31 1/2"x31 1/2" Nat. Ret.	80x80 31 1/2"x31 1/2" Lap. Ret.	240x120 96"x48" Nat. Ret.	240x120 96"x48" Lap. Ret.	120x120 48"x48" Nat. Ret.	120x120 48"x48" Lap. Ret.	30x30 12"x12" Nat. Ret.	30x30 12"x12" Lap. Ret.	8x80 3"x31 1/2" Nat. Ret.	8x80 3"x31 1/2" Lap. Ret.	20x160 8"x63" Nat. Ret.	20x160 8"x63" Lap. Ret.	20x80 8"x31 1/2" Nat. Ret.	20x80 8"x31 1/2" Lap. Ret.
LASA	087004	087003	087044	087043	087084	087083	087104	087103	087024	087023	087064	087063	087194	087193	087204	087203	087275	087274	087295	087294
PREZZO PRICE	€ 106,00 m ²	€ 130,00 m ²	€ 94,00 m ²	€ 120,00 m ²	€ 74,00 m ²	€ 102,00 m ²	€ 62,00 m ²	€ 76,00 m ²	€ 86,00 m ²	€ 108,00 m ²	€ 74,00 m ²	€ 102,00 m ²	€ 126,00 m ²	€ 168,00 m ²	€ 7,00 PZ/PCE	€ 8,00 PZ/PCE	€ 30,00 PZ/PCE	€ 42,00 PZ/PCE	€ 22,00 PZ/PCE	€ 30,00 PZ/PCE
CODICE PREZZO PRICE CODE	M173	M197	M161	M187	M141	M169	M129	M143	M153	M175	M141	M169	M193	M235	P025	P029	P077	P101	P061	P077
IMBALLO cm h. PACKING cm h.	 345x175	 330x75	 182,6x173,6	 330x75	 168x97	EPAL 80x120			 264x136,6	 250x75	 143x123	 250x75	EPAL 80x120	Pallet 80x120		 168x97	Pallet 80x120			
Tara / Tare	140,00	210,00	71,80	210,00	-	20			100,00	158,00	-	158,00	-	-	-	-	-	-	-	-
N°	14	44	24	88	-	-			20	44	-	88	-	-	-	-	-	-	-	-
m ² x	5,12	5,12	2,56	2,56	-	-			2,88	2,88	-	1,44	-	-	-	-	-	-	-	-
Kg x	74,14	74,14	37,07	37,07	-	-			41,70	41,70	-	20,85	-	-	-	-	-	-	-	-
 x 	-	-	-	-	2	3			-	-	2	-	-	-	12	-	1	-	1	
m ² x 	-	-	-	-	2,56	1,92			-	-	2,88	-	-	-	0,77	-	-	-	-	
Kg x 	-	-	-	-	37,2	27,90			-	-	41,70	-	-	-	11,50	-	5	-	3	
 x 	-	-	-	-	15	40			-	-	24	-	-	-	-	-	-	-	-	
m ² x 	71,68	225,28	61,44	225,28	38,40	76,80			57,60	126,72	69,12	126,72	-	-	-	-	-	-	-	
Kg x 	1.178	3.472	962	3.472	648	1.141			934	1.993	1.057	1.993	-	-	-	-	-	-	-	



Cavalletto in legno
Wood A-Frame
Support en bois
Holzgestell
Caballete de madera
Деревянная подставка















Cassa
Crate
Caisse
Kiste
Caja
Ящик



Pallet speciale con sponde
Special pallet with sides
Palette spéciale avec bords
Spezial-Palette mit Wandungen
Palet especial con bordes
Специальный поддон с боковинами

6 mm

SOLO SUPERFICIE NATURALE
ONLY NATURAL SURFACE
ANSI A - 137.1: 2012
WET DYNAMIC COEFFICIENT OF FRICTION
DCOF ≥ 0,42

	Gradino costa retta Straight nosed stair **						Gradino costa retta - Angolo SX / DX Straight-edge step - LH/RH corner **						Gradino Bordo Dritto Straight-edge step **				Gradino Bordo Dritto - Angolo SX / DX Straight-edge step - LH/RH corner **							
	33x160x3,2h 13"x63"x1 1/4"h Nat. Ret.	33x160x3,2h 13"x63"x1 1/4"h Lap. Ret.	33x120x3,2h 13"x48"x1 1/4"h Nat. Ret.	33x120x3,2h 13"x48"x1 1/4"h Lap. Ret.	33x80x3,2h 13"x31 1/2"x1 1/4"h Nat. Ret.	33x80x3,2h 13"x31 1/2"x1 1/4"h Lap. Ret.	33x160x3,2h 13"x63"x1 1/4"h Nat. Ret.	33x160x3,2h 13"x63"x1 1/4"h Lap. Ret.	33x120x3,2h 13"x48"x1 1/4"h Nat. Ret.	33x120x3,2h 13"x48"x1 1/4"h Lap. Ret.	33x80x3,2h 13"x31 1/2"x1 1/4"h Nat. Ret.	33x80x3,2h 13"x31 1/2"x1 1/4"h Lap. Ret.	30x160x4h 12"x63"x1 1/2"h Nat. Ret.	30x160x4h 12"x63"x1 1/2"h Lap. Ret.	30x120x4h 12"x48"x1 1/2"h Nat. Ret.	30x120x4h 12"x48"x1 1/2"h Lap. Ret.	30x80x4h 12"x31 1/2"x1 1/2"h Nat. Ret.	30x80x4h 12"x31 1/2"x1 1/2"h Lap. Ret.	30x160x4h 12"x63"x1 1/2"h Nat. Ret.	30x160x4h 12"x63"x1 1/2"h Lap. Ret.	30x120x4h 12"x48"x1 1/2"h Nat. Ret.	30x120x4h 12"x48"x1 1/2"h Lap. Ret.	30x80x4h 12"x31 1/2"x1 1/2"h Nat. Ret.	30x80x4h 12"x31 1/2"x1 1/2"h Lap. Ret.
LASA	087315	087312	087348	087345	087238	087372	087317 SX 087316 DX	087314 SX 087313 DX	087350 SX 087349 DX	087347 SX 087346 DX	087376 SX 087375 DX	087374 SX 087373 DX	087242	087656	087454	087451	087497	087494	087426 SX 087425 DX	087424 SX 087423 DX	087456 SX 087455 DX	087453 SX 087452 DX	087499 SX 087498 DX	087496 SX 087495 DX
PREZZO PRICE	€ 272,00 PZIPCE	€ 312,00 PZIPCE	€ 176,00 PZIPCE	€ 198,00 PZIPCE	€ 100,00 PZIPCE	€ 108,00 PZIPCE	€ 304,00 PZIPCE	€ 344,00 PZIPCE	€ 212,00 PZIPCE	€ 232,00 PZIPCE	€ 136,00 PZIPCE	€ 148,00 PZIPCE	€ 178,00 PZIPCE	€ 200,00 PZIPCE	€ 126,00 PZIPCE	€ 134,00 PZIPCE	€ 68,00 PZIPCE	€ 76,00 PZIPCE	€ 240,00 PZIPCE	€ 276,00 PZIPCE	€ 178,00 PZIPCE	€ 190,00 PZIPCE	€ 116,00 PZIPCE	€ 130,00 PZIPCE
CODICE PREZZO PRICE CODE	P303	P323	P243	P265	P167	P175	P319	P339	P273	P283	P203	P215	P245	P267	P193	P201	P135	P143	P287	P305	P245	P257	P183	P197
IMBALLO cm h. PACKING cm h.	 168x97		Pallet 80x120		Pallet 80x120		 168x97		Pallet 80x120		Pallet 80x120		 168x97		Pallet 80x120		Pallet 80x120		 168x97		Pallet 80x120		Pallet 80x120	
Tara / Tare	-	-	-	-	-	-	-	-	-	-	-	-	-	-	-	-	-	-	-	-	-	-	-	-
 x 	1	2	2	1	1	1	1	1	1	1	1	1	2	2	1	1	1	1	1	1	1	1	1	1
m ² x 	-	-	-	-	-	-	-	-	-	-	-	-	-	-	-	-	-	-	-	-	-	-	-	-
Kg x 	9	14	10	10	10	7	10	7	6	6	6	8,5	13,5	9	9	9	9	9,5	7	7	5	5	5	5
 x 	-	-	-	-	-	-	-	-	-	-	-	-	-	-	-	-	-	-	-	-	-	-	-	-
m ² x 	-	-	-	-	-	-	-	-	-	-	-	-	-	-	-	-	-	-	-	-	-	-	-	-
Kg x 	-	-	-	-	-	-	-	-	-	-	-	-	-	-	-	-	-	-	-	-	-	-	-	-











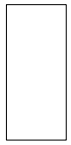

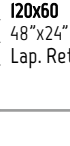

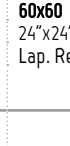

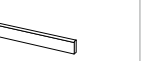
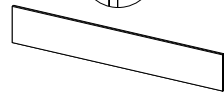

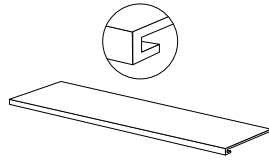
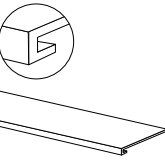
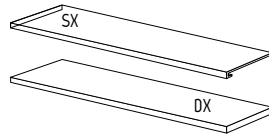
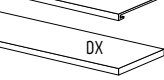
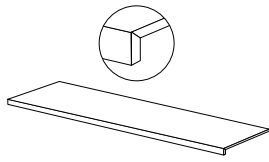
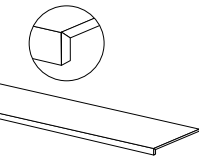
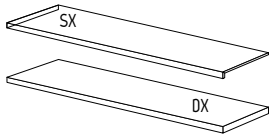
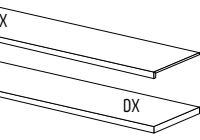









Pallet speciale con sponde
Special pallet with sides
Palette spéciale avec bords
Spezial-Palette mit Wandungen
Palet especial con bordes
Специальный поддон с боковинами

** PEZZI SPECIALI - A disposizione solo su richiesta. Tempi di consegna: 30gg.
TRIMS - Available upon request only. Delivery terms: 30 days.
PIÈCES SPECIALES - Disponible seulement sur requête. Délais de livraison: 30 jours.
FORMSTÜCKE - Verfügbar auf Anfrage. Lieferzeit: 30 Tage.
PIEZAS ESPECIALES - Disponible sólo bajo pedido. Plazo de entrega: 30 días.
СПЕЦИАЛЬНЫЕ ЭЛЕМЕНТЫ - Изготавливается только по специальной заявке. Срок поставки: 30 дней.

LASA INDOOR

10 mm

		modular system						Battiscopa Skirting		Scuretto Rabbeted riser		Gradino costa retta Straight nosed stair **		Gradino costa retta - Angolo SX / DX Straight-edge step - LH/RH corner **		Gradino Bordo Dritto Straight-edge step **		Gradino Bordo Dritto - Angolo SX / DX Straight-edge step - LH/RH corner **	
																			
	180x80 71"x31 1/2" Nat. Ret.	180x80 71"x31 1/2" Lap. Ret.	120x60 48"x24" Nat. Ret.	120x60 48"x24" Lap. Ret.	60x60 24"x24" Nat. Ret.	60x60 24"x24" Lap. Ret.	6,5x120 2 1/2"x48" Nat. Ret.	6,5x120 2 1/2"x48" Lap. Ret.	20x120 8"x48" Nat. Ret.	20x120 8"x48" Lap. Ret.	33x120x3,2h 13"x48"x1 1/4" Nat. Ret.	33x120x3,2h 13"x48"x1 1/4" Lap. Ret.	33x120x3,2h 13"x48"x1 1/4" Nat. Ret.	33x120x3,2h 13"x48"x1 1/4" Lap. Ret.	30x120x4h 12"x48"x1 1/2" Nat. Ret.	30x120x4h 12"x48"x1 1/2" Lap. Ret.	30x120x4h 12"x48"x1 1/2" Nat. Ret.	30x120x4h 12"x48"x1 1/2" Lap. Ret.	
LASA	087615	087612	087124	087123	087144	087143	087214	087213	087285	087240	087401	087239	087403 SX 087402 DX	087400 SX 087399 DX	087527	087634	087528 SX 087529 DX	087635 SX 087526 DX	
PREZZO PRICE	€ 58,00 m ²	€ 76,00 m ²	€ 46,00 m ²	€ 58,00 m ²	€ 36,00 m ²	€ 48,00 m ²	€ 8,00 PZ/PCE	€ 9,00 PZ/PCE	€ 26,00 PZ/PCE	€ 28,00 PZ/PCE	€ 140,00 PZ/PCE	€ 148,00 PZ/PCE	€ 164,00 PZ/PCE	€ 176,00 PZ/PCE	€ 106,00 PZ/PCE	€ 112,00 PZ/PCE	€ 134,00 PZ/PCE	€ 134,00 PZ/PCE	
CODICE PREZZO PRICE CODE	M125	M143	M109	M125	M089	M113	P029	P033	P069	P073	P207	P215	P231	P243	P173	P179	P201	P201	
																			
IMBALLO cm h. PACKING cm h.	97x188		EPAL 80x120		EPAL 80x120		Pallet 80x120		Pallet 80x120		Pallet 80x120		Pallet 80x120		Pallet 80x120		Pallet 80x120		
Tara / Tare	55	-	-	-	-	-	-	-	-	-	-	-	-	-	-	-	-	-	
 x 	2	2	2	3	6	1	2	1	2	1	2	1	2	2	1	2	1	1	
m ² x 	2,88	1,44	1,08	-	-	-	-	-	-	-	-	-	-	-	-	-	-	-	
Kg x 	69,12	33,41	24,80	11,4	12	22	11	12	22	11	22	11	22	22	11	22	11	11	
 x 	20	30	40	-	-	-	-	-	-	-	-	-	-	-	-	-	-	-	
m ² x 	57,6	43,2	43,2	-	-	-	-	-	-	-	-	-	-	-	-	-	-	-	
Kg x 	1.412	1.025	1.012	-	-	-	-	-	-	-	-	-	-	-	-	-	-	-	

SOLO SUPERFICIE NATURALE
ONLY NATURAL SURFACE

ANSI A - 137.1: 2012
WET DYNAMIC COEFFICIENT OF FRICTION
DCOF ≥ 0,42



Pallet speciale con sponde
Special pallet with sides
Palette spéciale avec bords
Spezial-Palette mit Wandungen
Palet especial con bordes
Специальный поддон с боковинами

** PEZZI SPECIALI - A disposizione solo su richiesta. Tempi di consegna: 30gg.
TRIMS - Available upon request only. Delivery terms: 30 days.
PIÈCES SPECIALES - Disponible seulement sur requête. Délais de livraison: 30 jours.
FORMSTÜCKE - Verfügbar auf Anfrage. Lieferzeit: 30 Tage.
PIEZAS ESPECIALES - Disponible sólo bajo pedido. Plazo de entrega: 30 días.
СПЕЦИАЛЬНЫЕ ЭЛЕМЕНТЫ - Изготавливается только по специальной заявке. Срок поставки: 30 дней.

NAUTILUS

LASTRE IN GRES PORCELLANATO PRESSATE A SECCO . DRY-PRESSED PORCELAIN STONWARE SLABS .
 DALLES EN GRÈS CÉRAMÉ PRESSÉES À SEC . TROCKENGEPRESSTE PLATTEN AUS FEINSTEINZEUG .
 PLANCHAS EN GRÉS PORCELÁNICO PRENSADAS EN SECO . КЕРАМОГРАНИТНЫЕ ПЛИТЫ СУХОГО ПРЕССОВАНИЯ .
 UNI EN 14411-ISO 13006 - Appendice C - Gruppo BIa - UGL

100% DESIGN
AND PRODUCTION
OF ITALY

V2
SHADE SPECTRUM
MODERATE

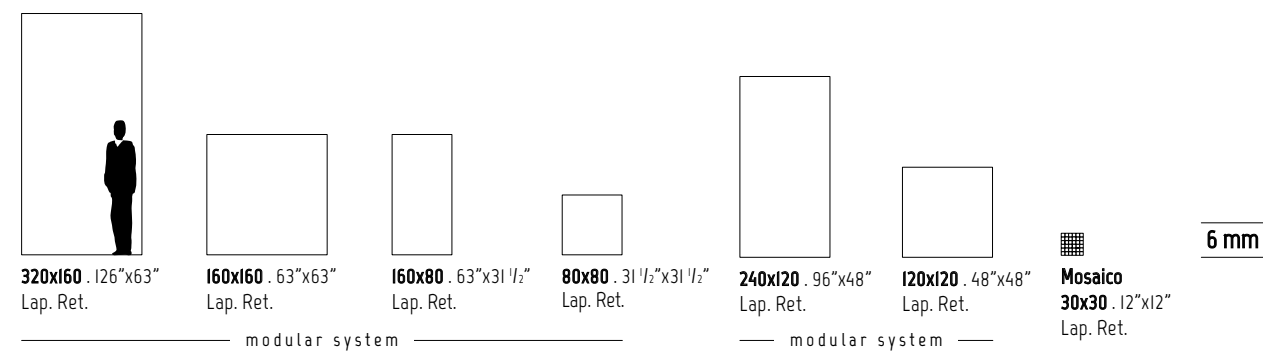

SVILUPPO GRAFICO PER FORMATO
 Pattern by size
 Développement graphique par format
 Grafischer Entwurf für Format
 Desarrollo gráfico por formato
 Варианты графики для каждого формата

320x160 6 mm	160x160 6 mm	160x80 6 mm	80x80 6 mm	240x120 6 mm	120x120 6 mm
6	12	24	48	10	20



Wall
Nautilus 320x160 (126"x63") Lap. Ret.

Floor
Nautilus 320x160 (126"x63") Lap. Ret.

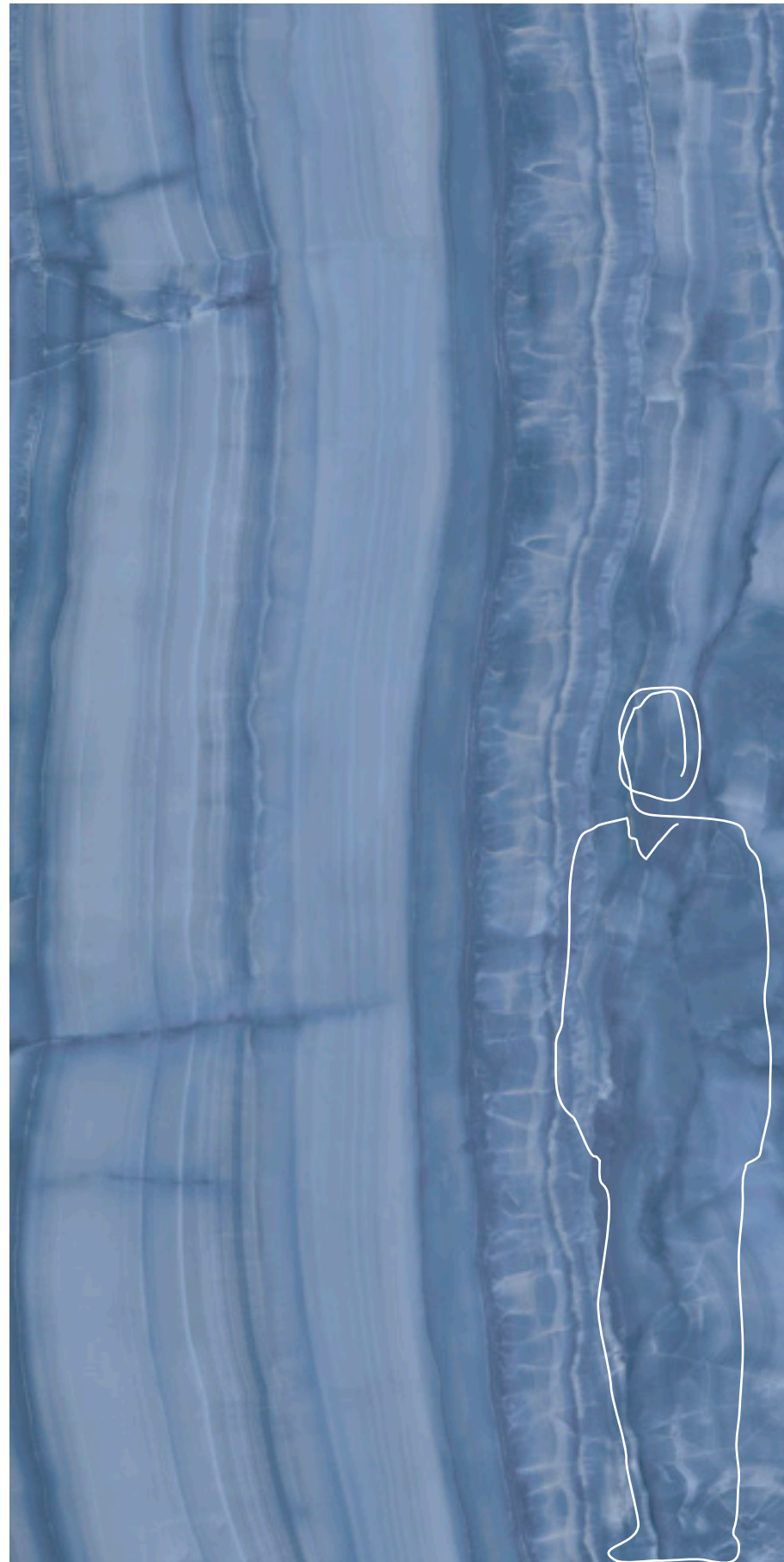

6 mm



113001
320x160 . 126"x63"
Lap. Ret.

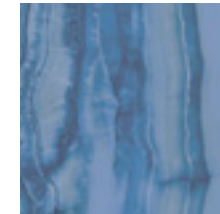

113020
160x160 . 63"x63"
Lap. Ret.



113040
160x80 . 63"x31 1/2"
Lap. Ret.



113045
80x80 . 31 1/2"x31 1/2"
Lap. Ret.



113010
240x120 . 96"x48"
Lap. Ret.



113030
120x120 . 48"x48"
Lap. Ret.



Mosaico
113302
30x30 . 12"x12"
Lap. Ret.

modular system

modular system

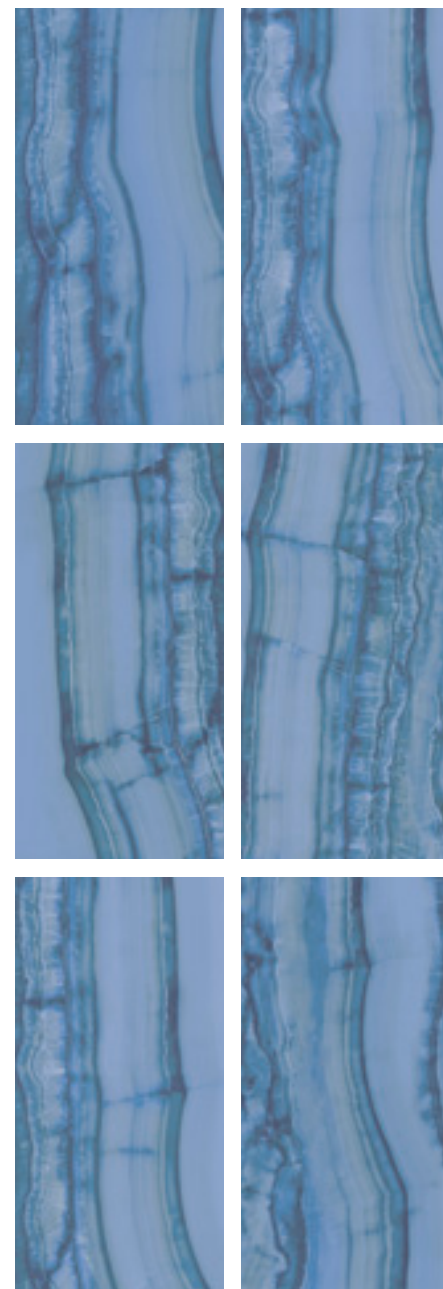

320x160
SVILUPPO GRAFICO PER FORMATO - 6 Pattern by size
6 Développement graphique par format - 6 Grafischer Entwurf für Format
6 Desarrollo gráfico por formato - 6 Варианты графики для каждого формата

NAUTILUS

6 mm

	modular system					modular system					Mosaico Mosaic	Battiscopa Skirting	Scuretto Rabbeted riser	Gradino costa retta Straight nosed stair	Gradino costa retta - Angolo SX / DX Straight-edge step - LH/RH corner			Gradino Bordo Dritto Straight-edge step			Gradino Bordo Dritto - Angolo SX / DX Straight-edge step - LH/RH corner					
	320x160 126"x63" Lap. Ret.	160x160 63"x63" Lap. Ret.	160x80 63"x31 1/2" Lap. Ret.	80x80 31 1/2"x31 1/2" Lap. Ret.	240x120 96"x48" Lap. Ret.	120x120 48"x48" Lap. Ret.	30x30 12"x12" Lap. Ret.	8x80 3"x31 1/2" Lap. Ret.	20x160 8"x63" Lap. Ret.	20x80 8"x31 1/2" Lap. Ret.	33x160x3,2h 13"x63"x1 1/4" Lap. Ret.	33x120x3,2h 13"x48"x1 1/4" Lap. Ret.	33x80x3,2h 13"x31 1/2"x1 1/4" Lap. Ret.	33x160x3,2h 13"x63"x1 1/4" Lap. Ret.	33x120x3,2h 13"x48"x1 1/4" Lap. Ret.	33x80x3,2h 13"x31 1/2"x1 1/4" Lap. Ret.	30x160x4h 12"x63"x1 1/2" Lap. Ret.	30x120x4h 12"x48"x1 1/2" Lap. Ret.	30x80x4h 12"x31 1/2"x1 1/2" Lap. Ret.	30x160x4h 12"x63"x1 1/2" Lap. Ret.	30x120x4h 12"x48"x1 1/2" Lap. Ret.	30x80x4h 12"x31 1/2"x1 1/2" Lap. Ret.				
NAUTILUS	I13001	I13020	I13040	I13045	I13010	I13030	I13302	I13102	I13105	I13109	I13201	I13210	I13219	I13203 SX I13202 DX	I13212 SX I13211 DX	I13221 SX I13220 DX	I13231	I13240	I13349	I13233 SX I13232 DX	I13242 SX I13241 DX	I13251 SX I13250 DX				
PREZZO PRICE	€ 162,00 m ²	€ 162,00 m ²	€ 156,00 m ²	€ 156,00 m ²	€ 140,00 m ²	€ 140,00 m ²	€ 204,00 m ²	€ 13,00 PZ/PCE	€ 60,00 PZ/PCE	€ 30,00 PZ/PCE	€ 340,00 PZ/PCE	€ 208,00 PZ/PCE	€ 138,00 PZ/PCE	€ 368,00 PZ/PCE	€ 236,00 PZ/PCE	€ 158,00 PZ/PCE	€ 208,00 PZ/PCE	€ 148,00 PZ/PCE	€ 96,00 PZ/PCE	€ 332,00 PZ/PCE	€ 216,00 PZ/PCE	€ 156,00 PZ/PCE				
CODICE PREZZO PRICE CODE	M229	M229	M223	M223	M207	M207	M269	P043	P127	P077	P337	P271	P205	P351	P285	P225	P271	P215	P163	P333	P275	P223				
IMBALLO cm h. PACKING cm h.	345x175 330x75	182,6x173,6 330x75	168x97	EPAL 80x120	264x136,6 250x75	143x123 250x75	EPAL 80x120	Pallet 80x120	168x97 Pallet 80x120	168x97 Pallet 80x120	168x97 Pallet 80x120	168x97 Pallet 80x120	168x97 Pallet 80x120	168x97 Pallet 80x120	168x97 Pallet 80x120	168x97 Pallet 80x120	168x97 Pallet 80x120	168x97 Pallet 80x120	168x97 Pallet 80x120	168x97 Pallet 80x120	168x97 Pallet 80x120	168x97 Pallet 80x120				
Tara / Tare	140,00	210,00	71,80	210,00	-	100,00	158,00	-	158,00	-	-	-	-	-	-	-	-	-	-	-	-	-	-			
N°	15	44	24	88	-	20	44	-	88	-	-	-	-	-	-	-	-	-	-	-	-	-	-			
m ² x	5,12	5,12	2,56	2,56	-	2,88	2,88	-	1,44	-	-	-	-	-	-	-	-	-	-	-	-	-	-			
Kg x	74,14	74,14	37,07	37,07	-	41,70	41,70	-	20,85	-	-	-	-	-	-	-	-	-	-	-	-	-	-			
m ² x	-	-	-	-	2	3	-	-	2	-	-	12	1	1	1	2	2	1	1	1	1	2	2	1	1	1
Kg x	-	-	-	-	37,2	27,90	-	-	41,70	-	-	11,50	5	3	9	14	10	10	7	6	8,5	13,5	9	9,5	7	5
m ² x	76,80	225,28	61,44	225,28	38,40	76,80	57,60	126,72	69,12	126,72	-	-	-	-	-	-	-	-	-	-	-	-	-	-	-	
Kg x	1.252	3.472	962	3.472	648	1.141	934	1.993	1.057	1.993	-	-	-	-	-	-	-	-	-	-	-	-	-	-	-	



Cavalletto in legno
Wood A-Frame
Support en bois
Holzgestell
Caballete de madera
Деревянная подставка



Cassa
Crate
Caisse
Kiste
Caja
Ящик



Pallet speciale con sponde
Special pallet with sides
Palette spéciale avec bords
Spezial-Palette mit Wandungen
Palet especial con bordes
Специальный поддон с боковинами

** PEZZI SPECIALI - A disposizione solo su richiesta. Tempi di consegna: 30gg.
TRIMS - Available upon request only. Delivery terms: 30 days.
PIÈCES SPECIALES - Disponible seulement sur requête. Délais de livraison: 30 jours.
FORMSTÜCKE - Verfügbar auf Anfrage. Lieferzeit: 30 Tage.
PIEZAS ESPECIALES - Disponible sólo bajo pedido. Plazo de entrega: 30 días.
СПЕЦИАЛЬНЫЕ ЭЛЕМЕНТЫ - Изготавливается только по специальной заявке. Срок поставки: 30 дней.

NERO BELVEDERE

LASTRE IN GRES PORCELLANATO PRESSATE A SECCO . DRY-PRESSED PORCELAIN STONEWARE SLABS .
 DALLES EN GRÈS CÉRAME PRESSÉES À SEC . TROCKENGEPRESSTE PLATTEN AUS FEINSTEINZEUG .
 PLANCHAS EN GRÈS PORCELÁNICO PRENSADAS EN SECO . КЕРАМОГРАНИТНЫЕ ПЛИТЫ СУХОГО ПРЕССОВАНИЯ .
 UNI EN 14411-ISO 13006 - Appendice G - Gruppo BIa - UGL

100% DESIGN
AND PRODUCTION
OF ITALY

V2
SHADE SPECTRUM
MODERATE

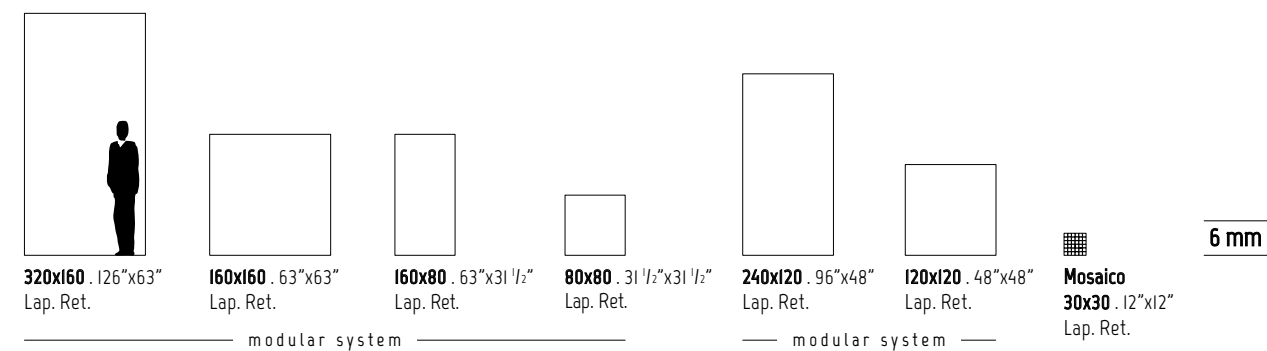

INDOOR

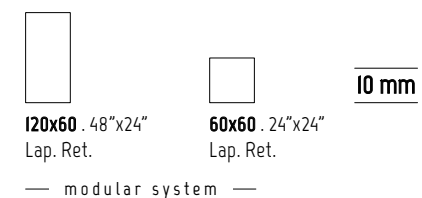

SVILUPPO GRAFICO PER FORMATO Pattern by size Développement graphique par format Grafischer Entwurf für Format Desarrollo gráfico por formato Варианты графики для каждого формата	320x160 6 mm	160x160 6 mm	160x80 6 mm	80x80 6 mm	240x120 6 mm	120x120 6 mm	120x60 10 mm	60x60 10 mm
	7	14	28	56	9	18	21	28



Wall
Collection Statuario Splendente 320x160 (126"x63") Lap. Ret.
Statuario Splendente Slab A / B 320x160 (126"x63") Lap. Ret.

Rivestimento desk / Wall desk
Nero Belvedere Lap. Ret.

Floor
Nero Belvedere 320x160 (126"x63") Lap. Ret.

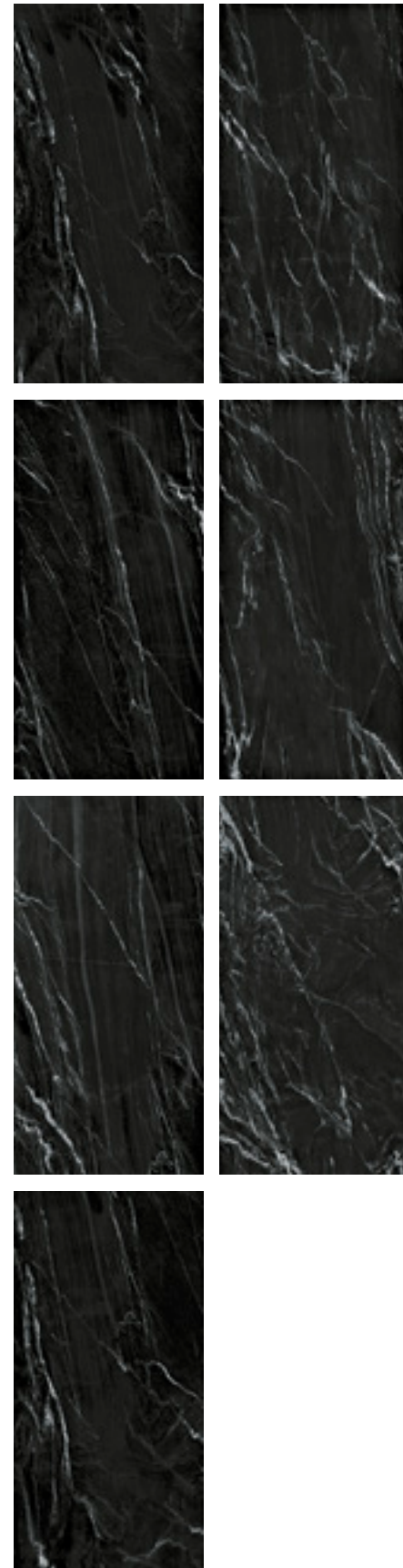

320x160
 SVILUPPO GRAFICO PER FORMATO - 7 Pattern by size
 7 Développement graphique par format - 7 Grafischer Entwurf für Format
 7 Desarrollo gráfico por formato - 7 Варианты графики для каждого формата

6 mm



087013
320x160 . 126"x63"
 Lap. Ret.

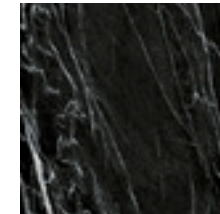

087049
160x160 . 63"x63"
 Lap. Ret.

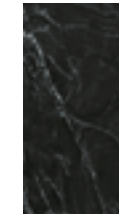

087089
160x80 . 63"x31 1/2"
 Lap. Ret.

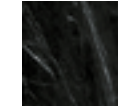

087109
80x80 . 31 1/2"x31 1/2"
 Lap. Ret.



087033
240x120 . 96"x48"
 Lap. Ret.



087069
120x120 . 48"x48"
 Lap. Ret.



Mosaico
087199
30x30 . 12"x12"
 Lap. Ret.

— modular system —

— modular system —

INDOOR

10 mm



087129
120x60 . 48"x24"
 Lap. Ret.



087149
60x60 . 24"x24"
 Lap. Ret.

— modular system —

NERO BELVEDERE

6 mm

SOLO SUPERFICIE NATURALE
ONLY NATURAL SURFACE

ANSI A - 137.1: 2012
WET DYNAMIC COEFFICIENT OF FRICTION
DCOF ≥ 0,42

	modular system					modular system					Mosaico Mosaic	Battiscopa Skirting	Scoretto Rabbeted riser	Gradino costa retta Straight nosed stair **	Gradino costa retta - Angolo SX / DX Straight-edge step - LH/RH corner **	Gradino Bordo Dritto Straight-edge step **	Gradino Bordo Dritto - Angolo SX / DX Straight-edge step - LH/RH corner **						
	320x160 126"x63" Lap. Ret.	160x160 63"x63" Lap. Ret.	160x80 63"x31 1/2" Lap. Ret.	80x80 31 1/2"x31 1/2" Lap. Ret.	240x120 96"x48" Lap. Ret.	120x120 48"x48" Lap. Ret.	30x30 12"x12" Lap. Ret.	8x80 3"x31 1/2" Lap. Ret.	20x160 8"x63" Lap. Ret.	20x80 8"x31 1/2" Lap. Ret.	33x160x3,2h 13"x63"x1 1/4" Lap. Ret.	33x120x3,2h 13"x48"x1 1/4" Lap. Ret.	33x80x3,2h 13"x31 1/2"x1 1/4" Lap. Ret.	33x160x3,2h 13"x63"x1 1/4" Lap. Ret.	33x120x3,2h 13"x48"x1 1/4" Lap. Ret.	33x80x3,2h 13"x31 1/2"x1 1/4" Lap. Ret.	30x160x4h 12"x63"x1 1/2" Lap. Ret.	30x120x4h 12"x48"x1 1/2" Lap. Ret.	30x80x4h 12"x31 1/2"x1 1/2" Lap. Ret.	30x160x4h 12"x63"x1 1/2" Lap. Ret.	30x120x4h 12"x48"x1 1/2" Lap. Ret.	30x80x4h 12"x31 1/2"x1 1/2" Lap. Ret.	
NERO BELVEDERE	087013	087049	087089	087109	087033	087069	087199	087209	087276	087457	087318	087458	087461	087319 SX 087320 DX	087460 SX 087459 DX	087463 SX 087462 DX	087466	087231	087500	087468 SX 087467 DX	087470 SX 087469 DX	087502 SX 087616 DX	
PREZZO PRICE	€ 130,00 m ²	€ 120,00 m ²	€ 102,00 m ²	€ 76,00 m ²	€ 108,00 m ²	€ 102,00 m ²	€ 168,00 m ²	€ 8,00 PZ/PCE	€ 42,00 PZ/PCE	€ 30,00 PZ/PCE	€ 312,00 PZ/PCE	€ 198,00 PZ/PCE	€ 108,00 PZ/PCE	€ 344,00 PZ/PCE	€ 232,00 PZ/PCE	€ 148,00 PZ/PCE	€ 200,00 PZ/PCE	€ 134,00 PZ/PCE	€ 76,00 PZ/PCE	€ 276,00 PZ/PCE	€ 190,00 PZ/PCE	€ 130,00 PZ/PCE	
CODICE PREZZO PRICE CODE	M197	M187	M169	M143	M175	M169	M235	P029	P101	P077	P323	P265	P175	P339	P283	P215	P267	P201	P143	P305	P257	P197	
						EPAL 80x120					EPAL 80x120	Pallet 80x120		Pallet 80x120		Pallet 80x120	Pallet 80x120		Pallet 80x120	Pallet 80x120		Pallet 80x120	Pallet 80x120
IMBALLO cm h. PACKING cm h.	37	193,5	40,4	193,5	40,9	-	40	153,5	64,7	153,5	-	-	40,9	-	40,9	-	-	40,9	-	-	40,9	-	-
Tara / Tare	140,00	210,00	71,80	210,00	-	20	100,00	158,00	-	158,00	-	-	-	-	-	-	-	-	-	-	-	-	-
N°	14	44	24	88	-	-	20	44	-	88	-	-	-	-	-	-	-	-	-	-	-	-	-
m ² x	5,12	5,12	2,56	2,56	-	-	2,88	2,88	-	1,44	-	-	-	-	-	-	-	-	-	-	-	-	-
Kg x	74,14	74,14	37,07	37,07	-	-	41,70	41,70	-	20,85	-	-	-	-	-	-	-	-	-	-	-	-	-
x	-	-	-	-	2	3	-	-	2	-	-	12	-	1	1	1	1	1	1	2	2	1	1
m ² x	-	-	-	-	2,56	1,92	-	-	2,88	-	-	0,77	-	-	-	-	-	-	-	-	-	-	-
Kg x	-	-	-	-	37,2	27,90	-	-	41,70	-	-	11,50	-	5	3	9	14	10	10	7	6	8,5	13,5
x	-	-	-	-	15	40	-	-	24	-	-	-	-	-	-	-	-	-	-	-	-	-	-
m ² x	71,68	225,28	61,44	225,28	38,40	76,80	57,60	126,72	69,12	126,72	-	-	-	-	-	-	-	-	-	-	-	-	-
Kg x	1.178	3.472	962	3.472	648	1.141	934	1.993	1.057	1.993	-	-	-	-	-	-	-	-	-	-	-	-	-



Cavalletto in legno
Wood A-Frame
Support en bois
Holzgestell
Caballete de madera
Деревянная подставка



Cassa
Crate
Caisse
Kiste
Caja
Ящик



Pallet speciale con sponde
Special pallet with sides
Palette spéciale avec bords
Spezial-Palette mit Wandungen
Palet especial con bordes
Специальный поддон с боковинами

** PEZZI SPECIALI - A disposizione solo su richiesta. Tempi di consegna: 30gg.

TRIMS - Available upon request only. Delivery terms: 30 days.

PIÈCES SPECIALES - Disponible seulement sur requête. Délais de livraison: 30 jours.

FORMSTÜCKE - Verfügbar auf Anfrage. Lieferzeit: 30 Tage.

PIEZAS ESPECIALES - Disponible sólo bajo pedido. Plazo de entrega: 30 días.

СПЕЦИАЛЬНЫЕ ЭЛЕМЕНТЫ - Изготавливается только по специальной заявке. Срок поставки: 30 дней.











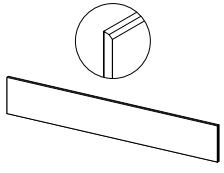
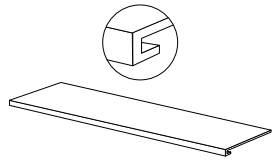
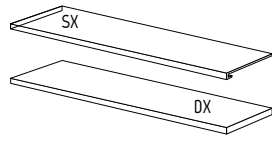
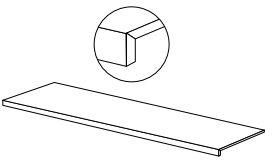
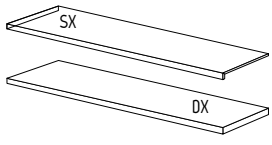

NERO BELVEDERE INDOOR

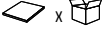
10 mm

modular system

SOLO SUPERFICIE NATURALE
ONLY NATURAL SURFACE

ANSI A - 137.1: 2012
WET DYNAMIC COEFFICIENT OF FRICTION | DCOF ≥ 0,42

	 120x60 48"x24" Lap. Ret.	 60x60 24"x24" Lap. Ret.	 6,5x120 2 1/2"x48" Lap. Ret.	 20x120 8"x48" Lap. Ret.	 33x120x3,2h 13"x48"x1 1/4" Lap. Ret.	 33x120x3,2h 13"x48"x1 1/4" Lap. Ret.	 30x120x4h 12"x48"x1 1/2" Lap. Ret.	 30x120x4h 12"x48"x1 1/2" Lap. Ret.
NERO BELVEDERE 	087129	087149	087219	087241	087232	087465 SX 087464 DX	087636	087638 SX 087637 DX
PREZZO PRICE	€ 58,00 m ²	€ 48,00 m ²	€ 9,00 PZ/PCE	€ 28,00 PZ/PCE	€ 148,00 PZ/PCE	€ 176,00 PZ/PCE	€ 112,00 PZ/PCE	€ 134,00 PZ/PCE
CODICE PREZZO PRICE CODE	M125	M113	P033	P073	P215	P243	P179	P201
	EPAL 80x120	EPAL 80x120	Pallet 80x120	Pallet 80x120	Pallet 80x120	Pallet 80x120	Pallet 80x120	Pallet 80x120
IMBALLO cm h. PACKING cm h.	-	-	-	-	-	-	-	-
Tara / Tare	20	20	-	-	-	-	-	-
 x 	2	3	6	1	2	1	2	1
m ² x 	1,44	1,08	-	-	-	-	-	-
Kg x 	33,41	24,80	11,4	12	22	11	22	11
 x 	30	40	-	-	-	-	-	-
m ² x 	43,2	43,2	-	-	-	-	-	-
Kg x 	1.025	1.012	-	-	-	-	-	-

**

PEZZI SPECIALI - A disposizione solo su richiesta. Tempi di consegna: 30gg.

TRIMS - Available upon request only. Delivery terms: 30 days.

PIÈCES SPECIALES - Disponible seulement sur requête. Délais de livraison: 30 jours.

FORMSTÜCKE - Verfügbar auf Anfrage. Lieferzeit: 30 Tage.

PIEZAS ESPECIALES - Disponible sólo bajo pedido. Plazo de entrega: 30 días.

СПЕЦИАЛЬНЫЕ ЭЛЕМЕНТЫ - Изготавливается только по специальной заявке. Срок поставки: 30 дней.

ONICE SERPENTINO

LASTRE IN GRES PORCELLANATO PRESSATE A SECCO . DRY-PRESSED PORCELAIN STONEWARE SLABS .
 DALLES EN GRÈS CÉRAME PRESSÉES À SEC . TROCKENGEPRESSTE PLATTEN AUS FEINSTEINZEUG .
 PLANCHAS EN GRÈS PORCELÁNICO PRENSADAS EN SECO . КЕРАМОГРАНИТНЫЕ ПЛИТЫ СУХОГО ПРЕССОВАНИЯ .
 UNI EN 14411-ISO 13006 - Appendice C - Gruppo BIa - UGL

100% DESIGN
 AND PRODUCTION
 OF ITALY

V2
 SHADE SPECTRUM
 MODERATE

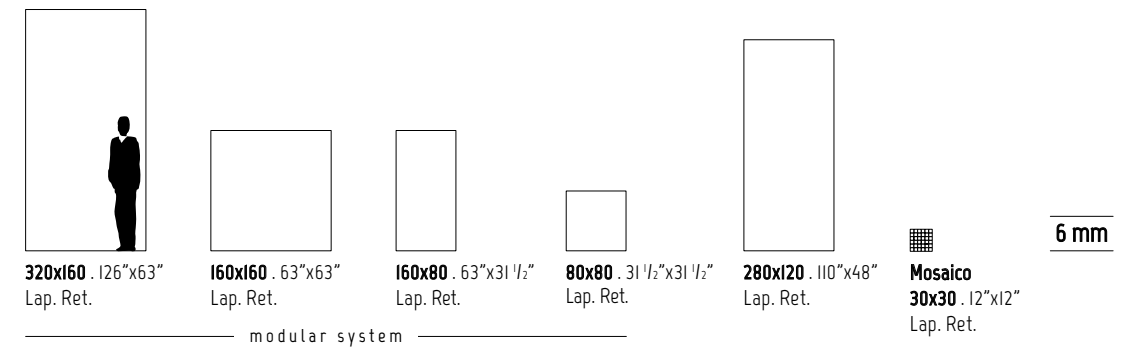

INDOOR

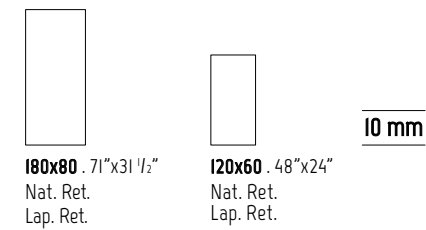

SVILUPPO GRAFICO PER FORMATO
 Pattern by size
 Développement graphique par format
 Grafischer Entwurf für Format
 Desarrollo gráfico por formato
 Варианты графики для каждого формата

	320x160 6 mm	160x160 6 mm	160x80 6 mm	80x80 6 mm	280x120 6 mm	180x80 10 mm	120x60 10 mm
	7	14	28	56	11	14	24

ONICE SERPENTINO

Wall
Onice Serpentino 320x160 (126"x63") Lap. Ret.
Collection Bronze Amani Lap. Ret.

Floor
Onice Serpentino 160x80 (63"x31 1/2") Lap. Ret.





320x160
SVILUPPO GRAFICO PER FORMATO - 7 Pattern by size
 7 Développement graphique par format - 7 Grafischer Entwurf für Format
 7 Desarrollo gráfico por formato - 7 Варианты графики для каждого формата

6 mm

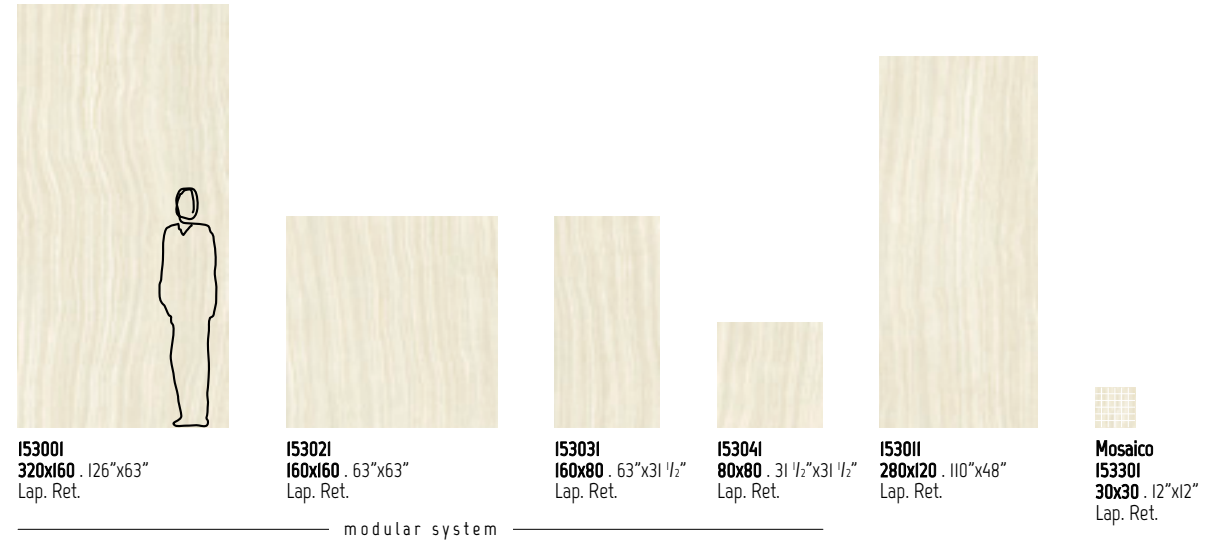

INDOOR

10 mm



ONICE SERPENTINO

6 mm

modular system

ANSI A - 137.1: 2012
WET DYNAMIC COEFFICIENT OF FRICTION | DCOF ≥ 0,42

	modular system				Mosaico Mosaic	Battiscopa Skirting	Scoretto Rabbeted riser	Gradino costa retta Straight nosed stair	Gradino costa retta - Angolo SX / DX Straight-edge step - LH/RH corner	Gradino Bordo Dritto Straight-edge step	Gradino Bordo Dritto - Angolo SX / DX Straight-edge step - LH/RH corner							
	320x160 126"x63" Lap. Ret.	160x160 63"x63" Lap. Ret.	160x80 63"x31 1/2" Lap. Ret.	80x80 31 1/2"x31 1/2" Lap. Ret.	280x120 110"x48" Lap. Ret.	30x30 12"x12" Lap. Ret.	8x80 3"x31 1/2" Lap. Ret.	20x160 8"x63" Lap. Ret.	20x80 8"x31 1/2" Lap. Ret.	33x160x3,2h 13"x63"x1 1/4" Lap. Ret.	33x80x3,2h 13"x31 1/2"x1 1/4" Lap. Ret.	33x160x3,2h 13"x63"x1 1/4" Lap. Ret.	33x80x3,2h 13"x31 1/2"x1 1/4" Lap. Ret.	30x160x4h 12"x63"x1 1/2" Lap. Ret.	30x80x4h 12"x31 1/2"x1 1/2" Lap. Ret.	30x160x4h 12"x63"x1 1/2" Lap. Ret.	30x80x4h 12"x31 1/2"x1 1/2" Lap. Ret.	
ONICE SERPENTINO	153001	153021	153031	153041	153011	153301	153102	153110	153112	153401	153404	153403 SX 153402 DX	153406 SX 153405 DX	153407	153410	153409 SX 153408 DX	153412 SX 153411 DX	
PREZZO PRICE	€ 130,00 m ²	€ 120,00 m ²	€ 102,00 m ²	€ 76,00 m ²	€ 108,00 m ²	€ 168,00 m ²	€ 8,00 PZ/PCE	€ 42,00 PZ/PCE	€ 30,00 PZ/PCE	€ 312,00 PZ/PCE	€ 108,00 PZ/PCE	€ 344,00 PZ/PCE	€ 148,00 PZ/PCE	€ 200,00 PZ/PCE	€ 76,00 PZ/PCE	€ 276,00 PZ/PCE	€ 130,00 PZ/PCE	
CODICE PREZZO PRICE CODE	M197	M187	M169	M143	M175	M235	P029	P101	P077	P323	P175	P339	P215	P267	P143	P305	P197	
IMBALLO cm h. PACKING cm h.	345x175	330x75	182,6x173,6	330x75	168x97	EPAL 80x120	302x136	330x75	EPAL 80x120	Pallet 80x120	168x97	Pallet 80x120	168x97	Pallet 80x120	168x97	Pallet 80x120	168x97	Pallet 80x120
Tara / Tare	140,00	210,00	71,80	210,00	-	20	108,00	210,00	-	-	-	-	-	-	-	-	-	-
N°	14	44	24	88	-	-	20	44	-	-	-	-	-	-	-	-	-	-
m ² x	5,12	5,12	2,56	2,56	-	-	3,36	3,36	-	-	-	-	-	-	-	-	-	-
Kg x	74,14	74,14	37,07	37,07	-	-	48,65	48,65	-	-	-	-	-	-	-	-	-	-
	-	-	-	-	2	3	-	-	-	12	-	-	-	-	-	-	-	-
m ² x	-	-	-	-	2,56	1,92	-	-	-	0,77	-	-	-	-	-	-	-	-
Kg x	-	-	-	-	37,2	27,90	-	-	-	11,50	-	-	-	-	-	-	-	-
	-	-	-	-	15	40	-	-	-	-	-	-	-	-	-	-	-	-
m ² x	71,68	225,28	61,44	225,28	38,40	76,80	67,2	147,84	-	-	-	-	-	-	-	-	-	-
Kg x	1.178	3.472	962	3.472	648	1.141	1.081	2.350	-	-	-	-	-	-	-	-	-	-



Cavalletto in legno
Wood A-Frame
Support en bois
Holzgestell
Caballete de madera
Деревянная подставка



Cassa
Crate
Caisse
Kiste
Caja
Ящик



Pallet speciale con sponde
Special pallet with sides
Palette spéciale avec bords
Spezial-Palette mit Wandungen
Palet especial con bordes
Специальный поддон с боковинами













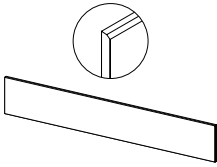
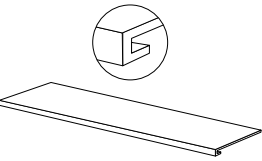
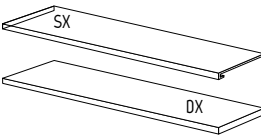
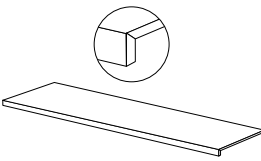
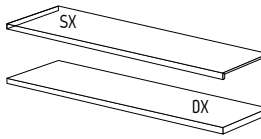

** PEZZI SPECIALI - A disposizione solo su richiesta. Tempi di consegna: 30gg.
TRIMS - Available upon request only. Delivery terms: 30 days.
PIÈCES SPECIALES - Disponible seulement sur requête. Délais de livraison: 30 jours.
FORMSTÜCKE - Verfügbar auf Anfrage. Lieferzeit: 30 Tage.
PIEZAS ESPECIALES - Disponible sólo bajo pedido. Plazo de entrega: 30 días.
СПЕЦИАЛЬНЫЕ ЭЛЕМЕНТЫ - Изготавливается только по специальной заявке. Срок поставки: 30 дней.

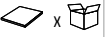
ONICE SERPENTINO INDOOR

10 mm

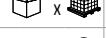
SOLO SUPERFICIE NATURALE
ONLY NATURAL SURFACE

ANSI A - 137.1: 2012
WET DYNAMIC COEFFICIENT OF FRICTION | DCOF ≥ 0,42

										
	180x80 71"x31 1/2" Nat. Ret.	180x80 71"x31 1/2" Lap. Ret.	120x60 48"x24" Nat. Ret.	120x60 48"x24" Lap. Ret.	6,5x120 2 1/2"x48" Lap. Ret.	20x120 8"x48" Lap. Ret.	33x120x3,2h 13"x48"x1 1/4" Lap. Ret.	33x120x3,2h 13"x48"x1 1/4" Lap. Ret.	30x120x4h 12"x48"x1 1/2" Lap. Ret.	30x120x4h 12"x48"x1 1/2" Lap. Ret.
ONICE SERPENTINO 	I53502	I53501	I53503	I53051	I53101	I53111	I53413	I53415 SX I53414 DX	I53416	I53418 SX I53417 DX
PREZZO PRICE	€ 58,00 m ²	€ 76,00 m ²	€ 46,00 m ²	€ 58,00 m ²	€ 9,00 PZ/PCE	€ 28,00 PZ/PCE	€ 148,00 PZ/PCE	€ 176,00 PZ/PCE	€ 112,00 PZ/PCE	€ 134,00 PZ/PCE
CODICE PREZZO PRICE CODE	M125	M143	M109	M125	P033	P073	P215	P243	P179	P201
	97x188		EPAL 80x120		Pallet 80x120	Pallet 80x120	Pallet 80x120	Pallet 80x120	Pallet 80x120	Pallet 80x120
IMBALLO cm h. PACKING cm h.	55		-		-	-	-	-	-	-
Tara / Tare	-		20		-	-	-	-	-	-
 x 	2		2		6	1	2	1	2	1
m ² x 	2,88		1,44		-	-	-	-	-	-
Kg x 	69,12		33,41		11,4	12	22	11	22	11
 x 	20		30		-	-	-	-	-	-
m ² x 	57,6		43,2		-	-	-	-	-	-
Kg x 	1.412		1.025		-	-	-	-	-	-



Pallet speciale con sponde
Special pallet with sides
Palette spéciale avec bords
Spezial-Palette mit Wandungen
Palet especial con bordes
Специальный поддон с боковинами

** PEZZI SPECIALI - A disposizione solo su richiesta. Tempi di consegna: 30gg.

TRIMS - Available upon request only. Delivery terms: 30 days.

PIÈCES SPECIALES - Disponible seulement sur requête. Délais de livraison: 30 jours.

FORMSTÜCKE - Verfügbar auf Anfrage. Lieferzeit: 30 Tage.

PIEZAS ESPECIALES - Disponible sólo bajo pedido. Plazo de entrega: 30 días.

СПЕЦИАЛЬНЫЕ ЭЛЕМЕНТЫ - Изготавливается только по специальной заявке. Срок поставки: 30 дней.

ONICE SMERALDO

LASTRE IN GRES PORCELLANATO PRESSATE A SECCO . DRY-PRESSED PORCELAIN STONWARE SLABS .
 DALLES EN GRÈS CÉRAMÉ PRESSÉES À SEC . TROCKENGEPRESSTE PLATTEN AUS FEINSTEINZEUG .
 PLANCHAS EN GRÈS PORCELÁNICO PRENSADAS EN SECO . КЕРАМОГРАНИТНЫЕ ПЛИТЫ СУХОГО ПРЕССОВАНИЯ .
 UNI EN 14411-ISO 13006 - Appendice C - Gruppo BIa - UCL

100% DESIGN
AND PRODUCTION
OF ITALY

V2
SHADE SPECTRUM
MODERATE

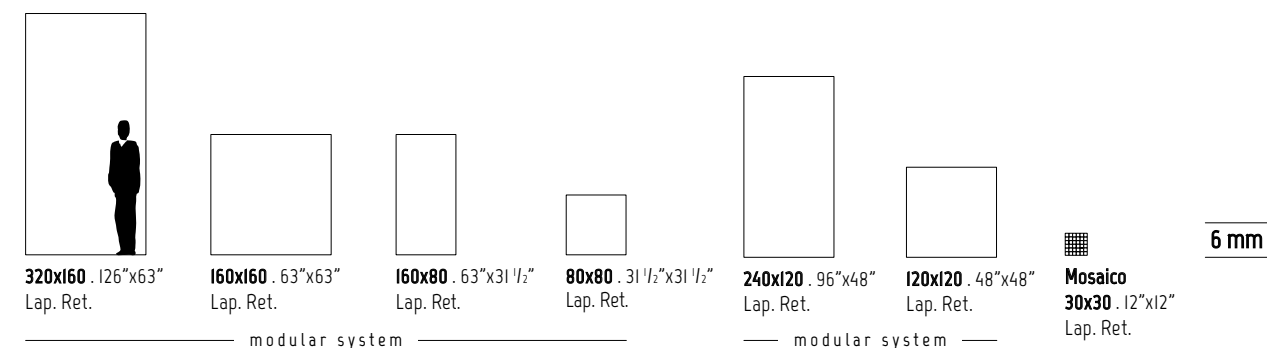

SVILUPPO GRAFICO PER FORMATO
Pattern by size
Développement graphique par format
Grafischer Entwurf für Format
Desarrollo gráfico por formato
Варианты графики для каждого формата

320x160 6 mm	160x160 6 mm	160x80 6 mm	80x80 6 mm	240x120 6 mm	120x120 6 mm
7	14	28	56	11	22

Onice Smeraldo 320x160 (126"x63") Lap. Ret. Wall





320x160
 SVILUPPO GRAFICO PER FORMATO - 7 Pattern by size
 7 Développement graphique par format - 7 Grafischer Entwurf für Format
 7 Desarrollo gráfico por formato - 7 Варианты графики для каждого формата

6 mm



113002
320x160 . 126"x63"
 Lap. Ret.

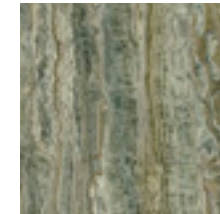

113021
160x160 . 63"x63"
 Lap. Ret.



113041
160x80 . 63"x31 1/2"
 Lap. Ret.

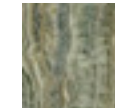

113046
80x80 . 31 1/2"x31 1/2"
 Lap. Ret.



113011
240x120 . 96"x48"
 Lap. Ret.

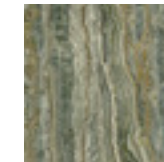

113031
120x120 . 48"x48"
 Lap. Ret.



Mosaico
113301
30x30 . 12"x12"
 Lap. Ret.

modular system

modular system

ONICE SMERALDO

6 mm

	modular system					modular system					Mosaico Mosaic	Battiscopa Skirting	Scuretto Rabbeted riser	Gradino costa retta Straight nosed stair **	Gradino costa retta - Angolo SX / DX Straight-edge step - LH/RH corner **	Gradino Bordo Dritto Straight-edge step **	Gradino Bordo Dritto - Angolo SX / DX Straight-edge step - LH/RH corner **									
	320x160 126"x63" Lap. Ret.	160x160 63"x63" Lap. Ret.	160x80 63"x31 1/2" Lap. Ret.	80x80 31 1/2"x31 1/2" Lap. Ret.	240x120 96"x48" Lap. Ret.	120x120 48"x48" Lap. Ret.	30x30 12"x12" Lap. Ret.	8x80 3"x31 1/2" Lap. Ret.	20x160 8"x63" Lap. Ret.	20x80 8"x31 1/2" Lap. Ret.	33x160x3,2h 13"x63"x1 1/4" Lap. Ret.	33x120x3,2h 13"x48"x1 1/4" Lap. Ret.	33x80x3,2h 13"x31 1/2"x1 1/4" Lap. Ret.	33x160x3,2h 13"x63"x1 1/4" Lap. Ret.	33x120x3,2h 13"x48"x1 1/4" Lap. Ret.	33x80x3,2h 13"x31 1/2"x1 1/4" Lap. Ret.	30x160x4h 12"x63"x1 1/2" Lap. Ret.	30x120x4h 12"x48"x1 1/2" Lap. Ret.	30x80x4h 12"x31 1/2"x1 1/2" Lap. Ret.	30x160x4h 12"x63"x1 1/2" Lap. Ret.	30x120x4h 12"x48"x1 1/2" Lap. Ret.	30x80x4h 12"x31 1/2"x1 1/2" Lap. Ret.				
ONICE SMERALDO	I13002	I13021	I13041	I13046	I13011	I13031	I13301	I13101	I13106	I13110	I13204	I13213	I13222	I13206 SX I13205 DX	I13215 SX I13214 DX	I13224 SX I13223 DX	I13234	I13243	I13352	I13236 SX I13235 DX	I13245 SX I13244 DX	I13254 SX I13253 DX				
PREZZO PRICE	€ 138,00 m ²	€ 126,00 m ²	€ 112,00 m ²	€ 81,00 m ²	€ 118,00 m ²	€ 110,00 m ²	€ 168,00 m ²	€ 8,00 PZ/PCE	€ 42,00 PZ/PCE	€ 30,00 PZ/PCE	€ 312,00 PZ/PCE	€ 198,00 PZ/PCE	€ 108,00 PZ/PCE	€ 344,00 PZ/PCE	€ 232,00 PZ/PCE	€ 148,00 PZ/PCE	€ 200,00 PZ/PCE	€ 134,00 PZ/PCE	€ 76,00 PZ/PCE	€ 276,00 PZ/PCE	€ 190,00 PZ/PCE	€ 130,00 PZ/PCE				
CODICE PREZZO PRICE CODE	M205	M193	M179	M148	M185	M177	M235	P029	P101	P077	P323	P265	P175	P339	P283	P215	P267	P201	P143	P305	P257	P197				
IMBALLO cm h. PACKING cm h.	345x175 330x75	182,6x173,6 330x75	168x97	EPAL 80x120	264x136,6 250x75	143x123 250x75	EPAL 80x120	Pallet 80x120	168x97 Pallet 80x120	168x97 Pallet 80x120	168x97 Pallet 80x120	168x97 Pallet 80x120	168x97 Pallet 80x120	168x97 Pallet 80x120	168x97 Pallet 80x120	168x97 Pallet 80x120	168x97 Pallet 80x120	168x97 Pallet 80x120	168x97 Pallet 80x120	168x97 Pallet 80x120	168x97 Pallet 80x120	168x97 Pallet 80x120				
Tara / Tare	140,00	210,00	71,80	210,00	-	20	100,00	158,00	-	158,00	-	-	-	-	-	-	-	-	-	-	-	-	-			
N°	14	44	24	88	-	-	20	44	-	88	-	-	-	-	-	-	-	-	-	-	-	-	-			
m ² x	5,12	5,12	2,56	2,56	-	-	2,88	2,88	-	1,44	-	-	-	-	-	-	-	-	-	-	-	-	-			
Kg x	74,14	74,14	37,07	37,07	-	-	41,70	41,70	-	20,85	-	-	-	-	-	-	-	-	-	-	-	-	-			
m ² x	-	-	-	-	2	3	-	-	2	-	-	12	1	1	1	2	2	1	1	1	1	2	2	1	1	1
Kg x	-	-	-	-	37,2	27,90	-	-	41,70	-	-	11,50	5	3	9	14	10	10	7	6	8,5	13,5	9	9,5	7	5
m ² x	71,68	225,28	61,44	225,28	38,40	76,80	57,60	126,72	69,12	126,72	-	-	-	-	-	-	-	-	-	-	-	-	-	-	-	
Kg x	1.178	3.472	962	3.472	648	1.141	934	1.993	1.057	1.993	-	-	-	-	-	-	-	-	-	-	-	-	-	-	-	



Cavalletto in legno
Wood A-Frame
Support en bois
Holzgestell
Caballete de madera
Деревянная подставка



Cassa
Crate
Caisse
Kiste
Caja
Ящик



Pallet speciale con sponde
Special pallet with sides
Palette spéciale avec bords
Spezial-Palette mit Wandungen
Palet especial con bordes
Специальный поддон с боковинами

** PEZZI SPECIALI - A disposizione solo su richiesta. Tempi di consegna: 30gg.
TRIMS - Available upon request only. Delivery terms: 30 days.
PIÈCES SPECIALES - Disponible seulement sur requête. Délais de livraison: 30 jours.
FORMSTÜCKE - Verfügbar auf Anfrage. Lieferzeit: 30 Tage.
PIEZAS ESPECIALES - Disponible sólo bajo pedido. Plazo de entrega: 30 días.
СПЕЦИАЛЬНЫЕ ЭЛЕМЕНТЫ - Изготавливается только по специальной заявке. Срок поставки: 30 дней.

PIRENEI

LASTRE IN GRES PORCELLANATO PRESSATE A SECCO . DRY-PRESSED PORCELAIN STONWARE SLABS .
 DALLES EN GRÈS CÉRAMÉ PRESSÉES À SEC . TROCKENGEPRESSTE PLATTEN AUS FEINSTEINZEUG .
 PLANCHAS EN GRES PORCELÁNICO PRENSADAS EN SECO . КЕРАМОГРАНИТНЫЕ ПЛИТЫ СУХОГО ПРЕССОВАНИЯ .
 UNI EN 14411-ISO 13006 - Appendice C - Gruppo BIa - UGL

100% DESIGN
AND PRODUCTION
OF ITALY

V2
SHADE SPECTRUM
MODERATE

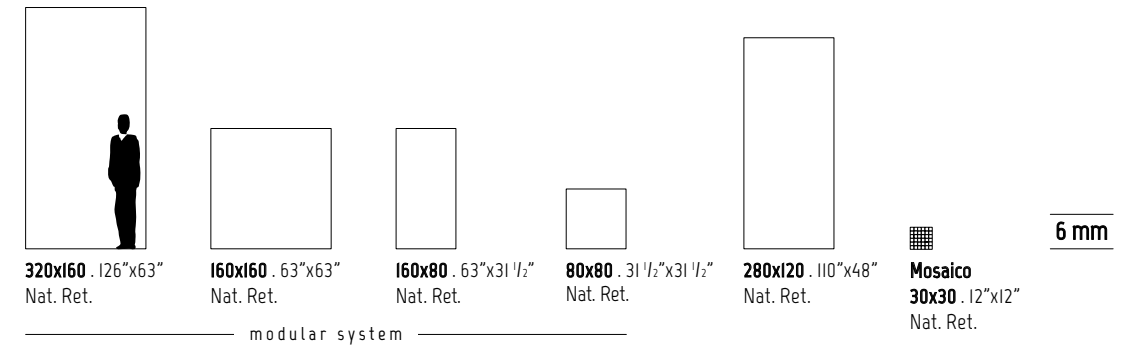

SVILUPPO GRAFICO PER FORMATO
 Pattern by size
 Développement graphique par format
 Grafischer Entwurf für Format
 Desarrollo gráfico por formato
 Варианты графики для каждого формата

320x160 6 mm	160x160 6 mm	160x80 6 mm	80x80 6 mm	280x120 6 mm
7	14	28	56	11

Arredi / Furniture
Collection Absolute: Black Nat. Ret.

Floor
Pirenei 120x120 (48"x48") Nat. Ret.



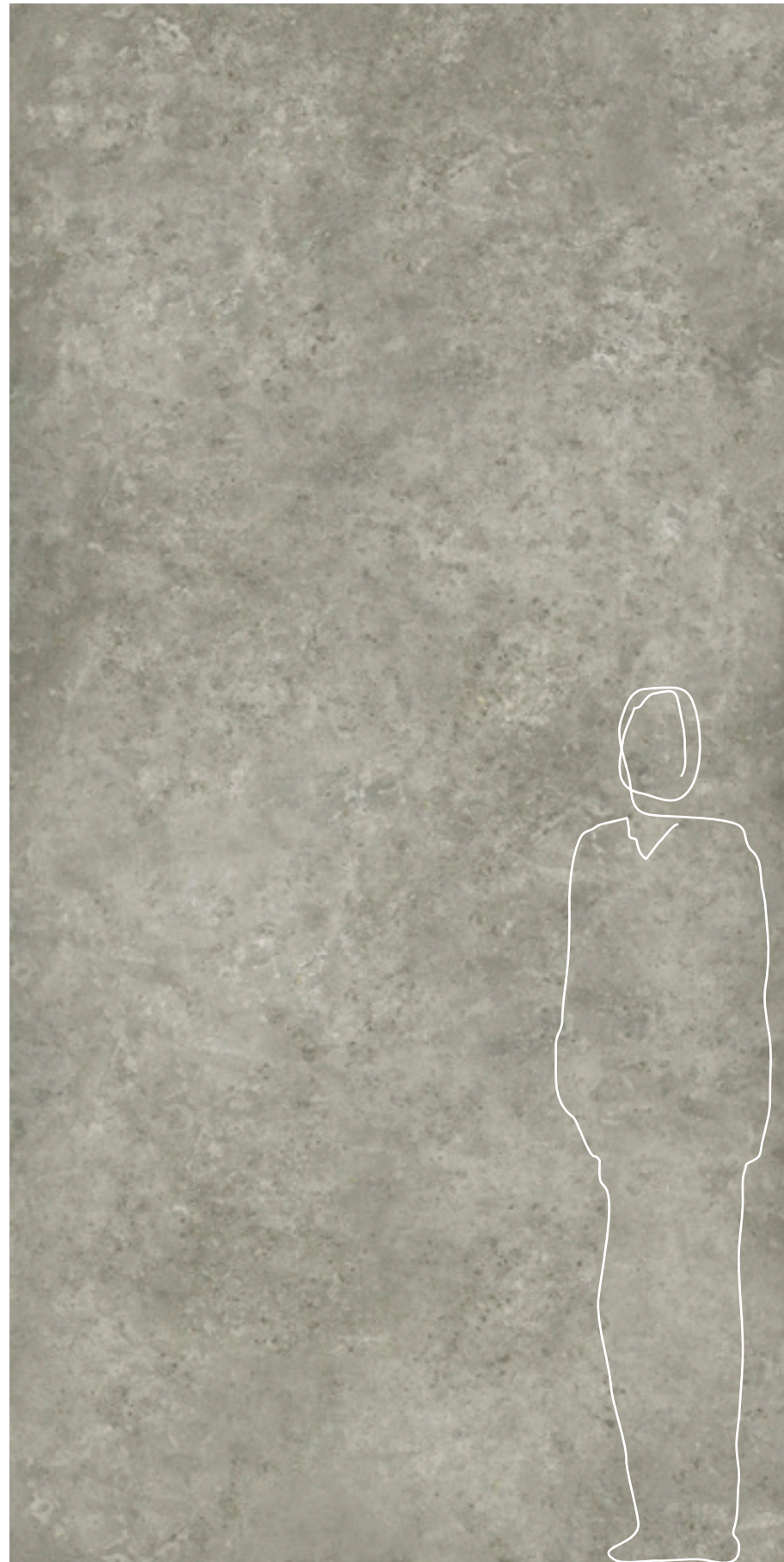

320x160
 SVILUPPO GRAFICO PER FORMATO - 7 Pattern by size
 7 Développement graphique par format - 7 Grafischer Entwurf für Format
 7 Desarrollo gráfico por formato - 7 Варианты графики для каждого формата

6 mm



I43001
320x160 . 126"x63"
 Nat. Ret.

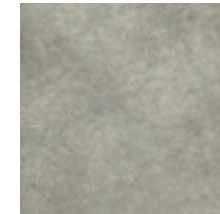

I43041
160x160 . 63"x63"
 Nat. Ret.

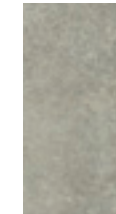

I43081
160x80 . 63"x31 1/2"
 Nat. Ret.

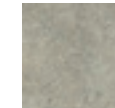

I43101
80x80 . 31 1/2"x31 1/2"
 Nat. Ret.



I43021
280x120 . 110"x48"
 Nat. Ret.



Mosaico
I43301
30x30 . 12"x12"
 Nat. Ret.

modular system

6 mm

modular system

ANSI A - 137.1: 2012
WET DYNAMIC COEFFICIENT OF FRICTION | DCOF ≥ 0,42

	modular system				Mosaico Mosaic	Battiscopa Skirting	Scuretto Rabbeted riser	Gradino costa retta Straight nosed stair **		Gradino costa retta - Angolo SX / DX Straight-edge step - LH/RH corner **		Gradino Bordo Dritto Straight-edge step **		Gradino Bordo Dritto - Angolo SX / DX Straight-edge step - LH/RH corner **					
	320x160 126"x63" Nat. Ret.	160x160 63"x63" Nat. Ret.	160x80 63"x31 1/2" Nat. Ret.	80x80 31 1/2"x31 1/2" Nat. Ret.	280x120 110"x48" Nat. Ret.	30x30 12"x12" Nat. Ret.	8x80 3"x31 1/2" Nat. Ret.	20x160 8"x63" Nat. Ret.	20x80 8"x31 1/2" Nat. Ret.	33x160x3,2h 13"x63"x1/4" Nat. Ret.	33x80x3,2h 13"x31 1/2"x1/4" Nat. Ret.	33x160x3,2h 13"x63"x1/4" Nat. Ret.	33x80x3,2h 13"x31 1/2"x1/4" Nat. Ret.	30x160x4h 12"x63"x1/2" Nat. Ret.	30x80x4h 12"x31 1/2"x1/2" Nat. Ret.	30x160x4h 12"x63"x1/2" Nat. Ret.	30x80x4h 12"x31 1/2"x1/2" Nat. Ret.		
PIRENEI	I43001	I43041	I43081	I43101	I43021	I43301	I43201	I43251	I43261	I43401	I43404	I43403 SX I43402 DX	I43406 SX I43405 DX	I43407	I43410	I43409 SX I43408 DX	I43412 SX I43411 DX		
PREZZO PRICE	€ 106,00 m ²	€ 94,00 m ²	€ 74,00 m ²	€ 62,00 m ²	€ 86,00 m ²	€ 126,00 m ²	€ 7,00 PZ/PCE	€ 30,00 PZ/PCE	€ 22,00 PZ/PCE	€ 272,00 PZ/PCE	€ 100,00 PZ/PCE	€ 304,00 PZ/PCE	€ 136,00 PZ/PCE	€ 178,00 PZ/PCE	€ 68,00 PZ/PCE	€ 240,00 PZ/PCE	€ 116,00 PZ/PCE		
CODICE PREZZO PRICE CODE	M173	M161	M141	M129	M153	M193	P025	P077	P061	P303	P167	P319	P203	P245	P135	P287	P183		
IMBALLO cm h. PACKING cm h.						EPAL 80x120			EPAL 80x120	Pallet 80x120		Pallet 80x120		Pallet 80x120		Pallet 80x120		Pallet 80x120	
Tara / Tare	37	193,5	40,4	193,5	40,9	-	33,8	193,5	-	-	40,9	-	40,9	-	40,9	-	40,9	-	
N°	14	44	24	88	-	20	108,00	210,00	-	-	-	-	-	-	-	-	-	-	
m ² x	5,12	5,12	2,56	2,56	-	-	3,36	3,36	-	-	-	-	-	-	-	-	-	-	
Kg x	74,14	74,14	37,07	37,07	-	-	48,65	48,65	-	-	-	-	-	-	-	-	-	-	
m ² x	-	-	-	-	2	3	-	-	-	1	1	1	2	1	1	1	2	1	1
Kg x	-	-	-	-	37,2	27,90	-	-	-	5	3	9	10	10	6	8,5	9	9,5	5
m ² x	71,68	225,28	61,44	225,28	38,40	76,80	67,2	147,84	-	-	-	-	-	-	-	-	-	-	-
Kg x	1.178	3.472	962	3.472	648	1.141	1.081	2.350	-	-	-	-	-	-	-	-	-	-	-



Cavalletto in legno
Wood A-Frame
Support en bois
Holzgestell
Caballete de madera
Деревянная подставка



Cassa
Crate
Caisse
Kiste
Caja
Ящик



Pallet speciale con sponde
Special pallet with sides
Palette spéciale avec bords
Spezial-Palette mit Wandungen
Palet especial con bordes
Специальный поддон с боковинами

** PEZZI SPECIALI - A disposizione solo su richiesta. Tempi di consegna: 30gg.
TRIMS - Available upon request only. Delivery terms: 30 days.
PIÈCES SPECIALES - Disponible seulement sur requête. Délais de livraison: 30 jours.
FORMSTÜCKE - Verfügbar auf Anfrage. Lieferzeit: 30 Tage.
PIEZAS ESPECIALES - Disponible sólo bajo pedido. Plazo de entrega: 30 días.
СПЕЦИАЛЬНЫЕ ЭЛЕМЕНТЫ - Изготавливается только по специальной заявке. Срок поставки: 30 дней.

PORTORO

LASTRE IN GRES PORCELLANATO PRESSATE A SECCO . DRY-PRESSED PORCELAIN STONWARE SLABS .
 DALLES EN GRÈS CÉRAMÉ PRESSÉES À SEC . TROCKENGEPRESSTE PLATTEN AUS FEINSTEINZEUG .
 PLANCHAS EN GRÈS PORCELÁNICO PRENSADAS EN SECO . КЕРАМОГРАНИТНЫЕ ПЛИТЫ СУХОГО ПРЕССОВАНИЯ .
 UNI EN 14411-ISO 13006 - Appendice C - Gruppo BIa - UCL

100% DESIGN
 AND PRODUCTION
 OF ITALY

V2
 SHADE SPECTRUM
 MODERATE

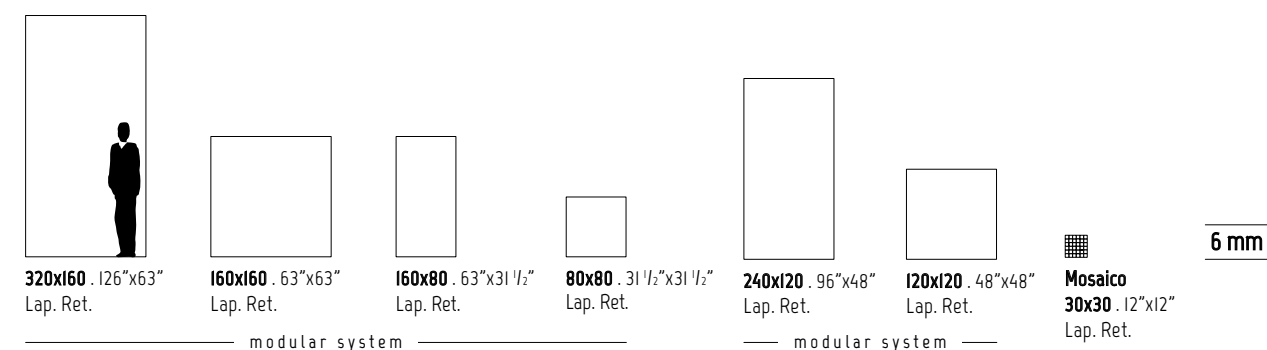

INDOOR

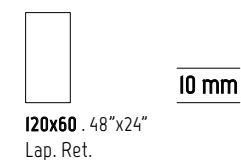

SVILUPPO GRAFICO PER FORMATO Pattern by size Développement graphique par format Grafischer Entwurf für Format Desarrollo gráfico por formato Варианты графики для каждого формата	320x160 6 mm	160x160 6 mm	160x80 6 mm	80x80 6 mm	240x120 6 mm	120x120 6 mm	120x60 10 mm
	7	14	28	56	11	22	28



Wall
Portoro 320x160 (126"x63") Lap. Ret.

Vasca da bagno / Bathtub
Portoro Lap. Ret.

Floor
Portoro 320x160 (126"x63") Lap. Ret.

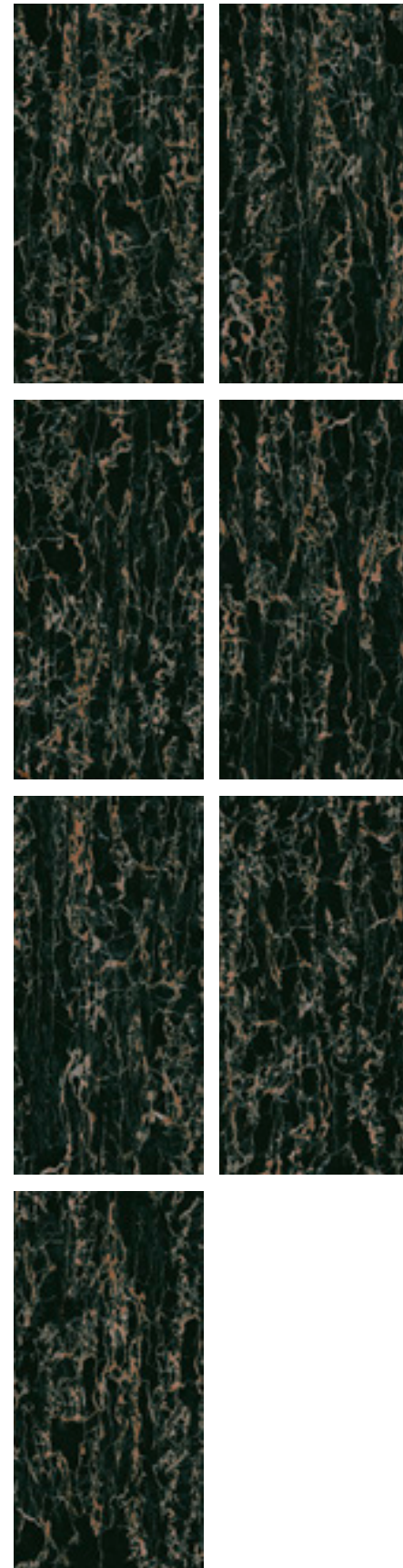

320x160
SVILUPPO GRAFICO PER FORMATO - 7 Pattern by size
7 Développement graphique par format - 7 Grafischer Entwurf für Format
7 Desarrollo gráfico por formato - 7 Варианты графики для каждого формата

6 mm



113003
320x160 . 126"x63"
Lap. Ret.

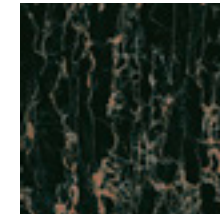

113022
160x160 . 63"x63"
Lap. Ret.



113042
160x80 . 63"x31 1/2"
Lap. Ret.

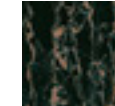

113047
80x80 . 31 1/2"x31 1/2"
Lap. Ret.

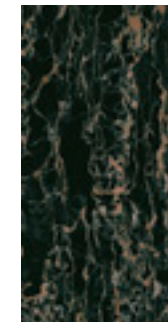

113012
240x120 . 96"x48"
Lap. Ret.

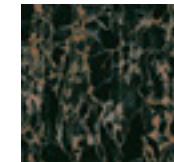

113032
120x120 . 48"x48"
Lap. Ret.



Mosaico
113303
30x30 . 12"x12"
Lap. Ret.

modular system

modular system

INDOOR

10 mm



113052
120x60 . 48"x24"
Lap. Ret.

PORTORO

6 mm

	modular system					modular system					Mosaico Mosaic	Battiscopa Skirting	Scuretto Rabbeted riser	Gradino costa retta Straight nosed stair **			Gradino costa retta - Angolo SX / DX Straight-edge step - LH/RH corner **			Gradino Bordo Dritto Straight-edge step **			Gradino Bordo Dritto - Angolo SX / DX Straight-edge step - LH/RH corner **		
	320x160 126"x63" Lap. Ret.	160x160 63"x63" Lap. Ret.	160x80 63"x31 1/2" Lap. Ret.	80x80 31 1/2"x31 1/2" Lap. Ret.	240x120 96"x48" Lap. Ret.	120x120 48"x48" Lap. Ret.	30x30 12"x12" Lap. Ret.	8x80 3"x31 1/2" Lap. Ret.	20x160 8"x63" Lap. Ret.	20x80 8"x31 1/2" Lap. Ret.				33x160x3,2h 13"x63"x1 1/4" Lap. Ret.	33x120x3,2h 13"x48"x1 1/4" Lap. Ret.	33x80x3,2h 13"x31 1/2"x1 1/4" Lap. Ret.	33x160x3,2h 13"x63"x1 1/4" Lap. Ret.	33x120x3,2h 13"x48"x1 1/4" Lap. Ret.	33x80x3,2h 13"x31 1/2"x1 1/4" Lap. Ret.	30x160x4h 12"x63"x1 1/2" Lap. Ret.	30x120x4h 12"x48"x1 1/2" Lap. Ret.	30x80x4h 12"x31 1/2"x1 1/2" Lap. Ret.	30x160x4h 12"x63"x1 1/2" Lap. Ret.	30x120x4h 12"x48"x1 1/2" Lap. Ret.	30x80x4h 12"x31 1/2"x1 1/2" Lap. Ret.
PORTORO	113003	113022	113042	113047	113012	113032	113303	113103	113107	113111	113207	113216	113225	113209 SX 113208 DX	113218 SX 113217 DX	113227 SX 113226 DX	113237	113246	113355	113239 SX 113238 DX	113248 SX 113247 DX	113257 SX 113256 DX			
PREZZO PRICE	€ 138,00 m ²	€ 126,00 m ²	€ 112,00 m ²	€ 81,00 m ²	€ 118,00 m ²	€ 110,00 m ²	€ 168,00 m ²	€ 8,00 PZ/PCE	€ 42,00 PZ/PCE	€ 30,00 PZ/PCE	€ 312,00 PZ/PCE	€ 198,00 PZ/PCE	€ 108,00 PZ/PCE	€ 344,00 PZ/PCE	€ 232,00 PZ/PCE	€ 148,00 PZ/PCE	€ 200,00 PZ/PCE	€ 134,00 PZ/PCE	€ 76,00 PZ/PCE	€ 276,00 PZ/PCE	€ 190,00 PZ/PCE	€ 130,00 PZ/PCE			
CODICE PREZZO PRICE CODE	M205	M193	M179	M148	M185	M177	M235	P029	P101	P077	P323	P265	P175	P339	P283	P215	P267	P201	P143	P305	P257	P197			
IMBALLO cm h. PACKING cm h.	345x175	330x75	182,6x173,6	330x75	168x97	EPAL 80x120	264x136,6	250x75	143x123	250x75	EPAL 80x120	Pallet 80x120	168x97	Pallet 80x120	168x97	Pallet 80x120	Pallet 80x120	168x97	Pallet 80x120	Pallet 80x120	168x97	Pallet 80x120	Pallet 80x120		
Tara / Tare	140,00	210,00	71,80	210,00	-	20	100,00	158,00	-	158,00	-	-	-	-	-	-	-	-	-	-	-	-	-		
N°	14	44	24	88	-	-	20	44	-	88	-	-	-	-	-	-	-	-	-	-	-	-	-		
m ² x	5,12	5,12	2,56	2,56	-	-	2,88	2,88	-	1,44	-	-	-	-	-	-	-	-	-	-	-	-	-		
Kg x	74,14	74,14	37,07	37,07	-	-	41,70	41,70	-	20,85	-	-	-	-	-	-	-	-	-	-	-	-	-		
m ² x	-	-	-	-	2	3	-	-	2	-	-	12	-	1	1	1	2	2	1	1	2	2	1	1	
Kg x	-	-	-	-	2,56	1,92	-	-	2,88	-	-	0,77	-	-	-	-	-	-	-	-	-	-	-		
m ² x	-	-	-	-	37,2	27,90	-	-	41,70	-	-	11,50	-	5	3	9	14	10	10	7	6	8,5	13,5	9	
Kg x	-	-	-	-	15	40	-	-	24	-	-	-	-	-	-	-	-	-	-	-	-	-	-		
m ² x	71,68	225,28	61,44	225,28	38,40	76,80	57,60	126,72	69,12	126,72	-	-	-	-	-	-	-	-	-	-	-	-	-		
Kg x	1.178	3.472	962	3.472	648	1.141	934	1.993	1.057	1.993	-	-	-	-	-	-	-	-	-	-	-	-	-		



Cavalletto in legno
Wood A-Frame
Support en bois
Holzgestell
Caballete de madera
Деревянная подставка



Cassa
Crate
Caisse
Kiste
Caja
Ящик













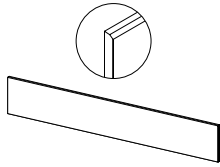
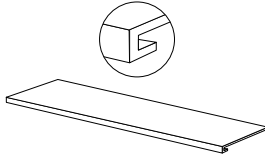
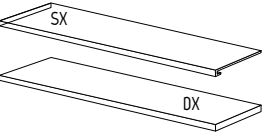
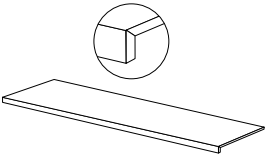
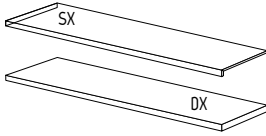

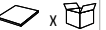
Pallet speciale con sponde
Special pallet with sides
Palette spéciale avec bords
Spezial-Palette mit Wandungen
Palet especial con bordes
Специальный поддон с боковинами

** PEZZI SPECIALI - A disposizione solo su richiesta. Tempi di consegna: 30gg.
TRIMS - Available upon request only. Delivery terms: 30 days.
PIÈCES SPECIALES - Disponible seulement sur requête. Délais de livraison: 30 jours.
FORMSTÜCKE - Verfügbar auf Anfrage. Lieferzeit: 30 Tage.
PIEZAS ESPECIALES - Disponible sólo bajo pedido. Plazo de entrega: 30 días.
СПЕЦИАЛЬНЫЕ ЭЛЕМЕНТЫ - Изготавливается только по специальной заявке. Срок поставки: 30 дней.

PORTORO INDOOR

10 mm

	 120x60 48"x24" Lap. Ret.	 6,5x120 2 1/2"x48" Lap. Ret.	 20x120 8"x48" Lap. Ret.	 Gradino costa retta Straight nosed stair ** 33x120x3,2h 13"x48"x1 1/4" Lap. Ret.	 Gradino costa retta - Angolo SX / DX Straight-edge step - LH/RH corner ** 33x120x3,2h 13"x48"x1 1/4" Lap. Ret.	 Gradino Bordo Dritto Straight-edge step ** 30x120x4h 12"x48"x1 1/2" Lap. Ret.	 Gradino Bordo Dritto - Angolo SX / DX Straight-edge step - LH/RH corner ** 30x120x4h 12"x48"x1 1/2" Lap. Ret.
PORTORO 	113052	113104	113108	113228	113230 SX 113229 DX	113258	113260 SX 113259 DX
PREZZO PRICE	€ 66,00 m ²	€ 9,00 PZ/PCE	€ 28,00 PZ/PCE	€ 148,00 PZ/PCE	€ 176,00 PZ/PCE	€ 112,00 PZ/PCE	€ 134,00 PZ/PCE
CODICE PREZZO PRICE CODE	M133	P033	P073	P215	P243	P179	P201
	EPAL 80x120	Pallet 80x120	Pallet 80x120	Pallet 80x120	Pallet 80x120	Pallet 80x120	Pallet 80x120
IMBALLO cm h. PACKING cm h.	-	-	-	-	-	-	-
Tara / Tare	20	-	-	-	-	-	-
 x 	2	6	1	2	1	2	1
m ² x 	1,44	-	-	-	-	-	-
Kg x 	33,41	11,4	12	22	11	22	11
 x 	30	-	-	-	-	-	-
m ² x 	43,2	-	-	-	-	-	-
Kg x 	1.025	-	-	-	-	-	-

**

PEZZI SPECIALI - A disposizione solo su richiesta. Tempi di consegna: 30gg.

TRIMS - Available upon request only. Delivery terms: 30 days.

PIÈCES SPECIALES - Disponible seulement sur requête. Délais de livraison: 30 jours.

FORMSTÜCKE - Verfügbar auf Anfrage. Lieferzeit: 30 Tage.

PIEZAS ESPECIALES - Disponible sólo bajo pedido. Plazo de entrega: 30 días.

СПЕЦИАЛЬНЫЕ ЭЛЕМЕНТЫ - Изготавливается только по специальной заявке. Срок поставки: 30 дней.

Vasca da bagno / Bathtub
Portoro Lap. Ret.

Floor
Portoro 320x160 (126"x63") Lap. Ret.



STATUARIO

LASTRE IN GRES PORCELLANATO PRESSATE A SECCO . DRY-PRESSED PORCELAIN STONEWARE SLABS .
 DALLES EN GRÈS CÉRAME PRESSÉES À SEC . TROCKENGEPRESSTE PLATTEN AUS FEINSTEINZEUG .
 PLANCHAS EN GRÈS PORCELÁNICO PRENSADAS EN SECO . КЕРАМОГРАНИТНЫЕ ПЛИТЫ СУХОГО ПРЕССОВАНИЯ .
 UNI EN 14411-ISO 13006 - Appendice C - Gruppo B1a - UGL

100% DESIGN
 AND PRODUCTION
 OF ITALY

V2
 SHADE SPECTRUM
 MODERATE

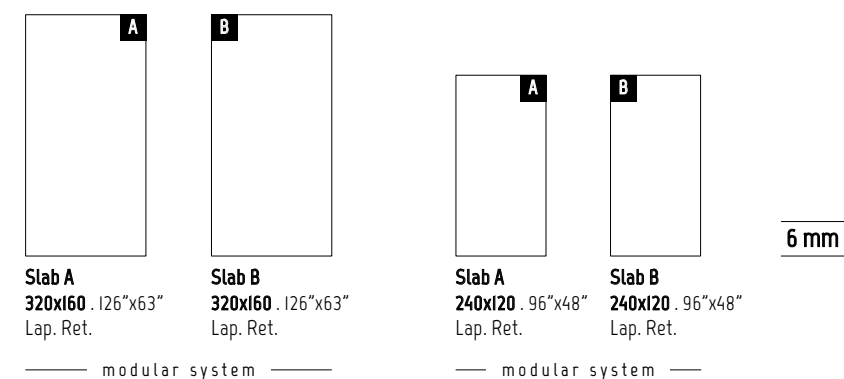
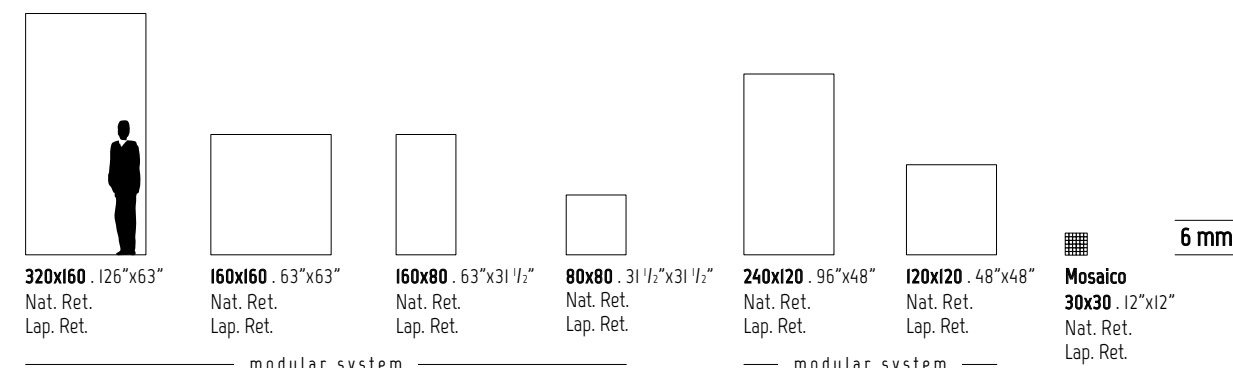

INDOOR

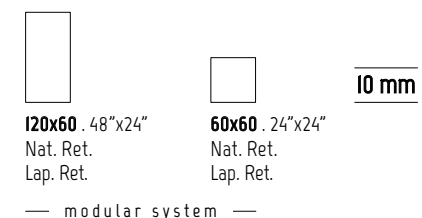

SVILUPPO GRAFICO PER FORMATO Pattern by size Développement graphique par format Grafischer Entwurf für Format Desarrollo gráfico por formato Варианты графики для каждого формата	320x160 6 mm	320x160 6 mm	160x160 6 mm	160x80 6 mm	80x80 6 mm	240x120 6 mm	240x120 6 mm	120x120 6 mm	120x60 10 mm	60x60 10 mm
	7	2 Slab A/B	14	28	56	11	2 Slab A/B	22	30	30

Wall
Statuario Slab A/B 320x160 (126"x63") Lap. Ret.

Rivestimento parete sx / Left wall tile
Statuario 320x160 (126"x63") Lap. Ret.

Floor
Statuario 160x160 (63"x63") Lap. Ret.



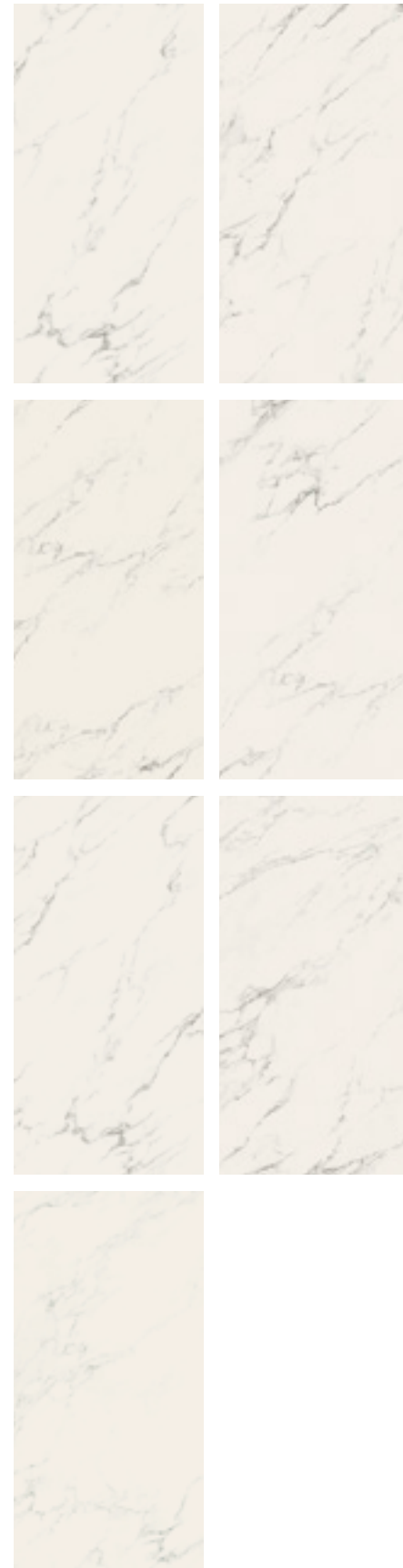
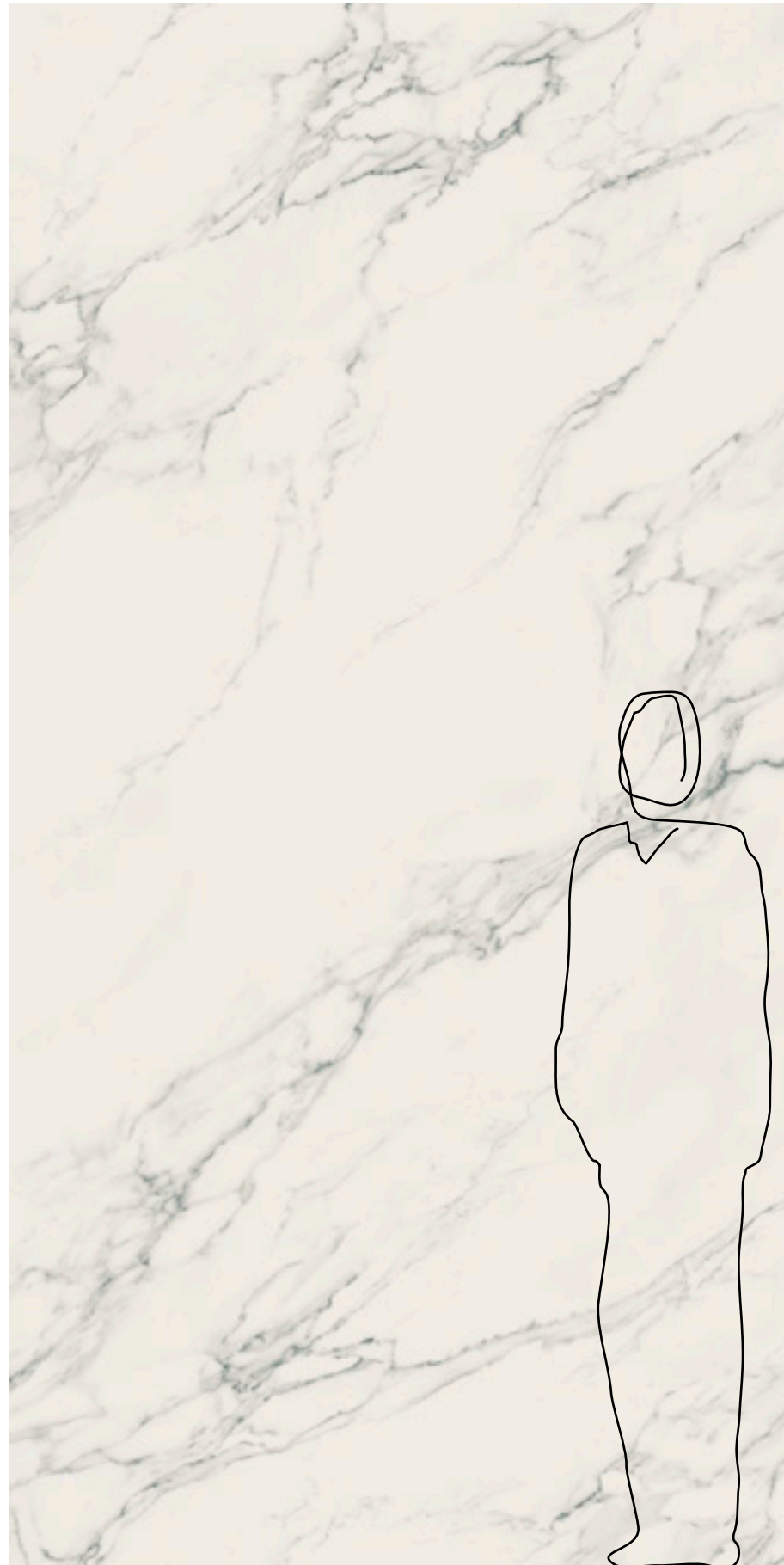

6 mm



083004
320x160 . 126"x63"
Nat. Ret.

083003
320x160 . 126"x63"
Lap. Ret.

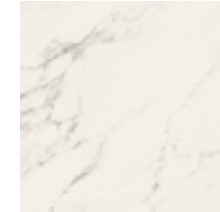

083024
160x160 . 63"x63"
Nat. Ret.

083023
160x160 . 63"x63"
Lap. Ret.



083044
160x80 . 63"x31 1/2"
Nat. Ret.

083043
160x80 . 63"x31 1/2"
Lap. Ret.



083054
80x80 . 31 1/2"x31 1/2"
Nat. Ret.

083053
80x80 . 31 1/2"x31 1/2"
Lap. Ret.

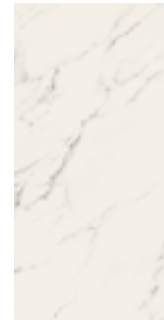

083014
240x120 . 96"x48"
Nat. Ret.

083013
240x120 . 96"x48"
Lap. Ret.

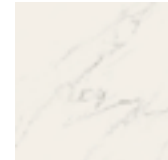

083034
120x120 . 48"x48"
Nat. Ret.

083033
120x120 . 48"x48"
Lap. Ret.



Mosaico
083194
30x30 . 12"x12"
Nat. Ret.

083193
30x30 . 12"x12"
Lap. Ret.

modular system

modular system

INDOOR

10 mm

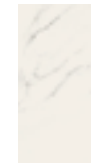

083064
120x60 . 48"x24"
Nat. Ret.

083063
120x60 . 48"x24"
Lap. Ret.



083084
60x60 . 24"x24"
Nat. Ret.

083083
60x60 . 24"x24"
Lap. Ret.

modular system

320x160

SVILUPPO GRAFICO PER FORMATO - 7 Pattern by size
7 Développement graphique par format - 7 Grafischer Entwurf für Format
7 Desarrollo gráfico por formato - 7 Варианты графики для каждого формата

STATUARIO

6 mm



Slab A
083091
320x160 . 126"x63"
Lap. Ret.

Slab B
083092
320x160 . 126"x63"
Lap. Ret.

modular system



Slab A
083110
240x120 . 96"x48"
Lap. Ret.

Slab B
083111
240x120 . 96"x48"
Lap. Ret.

modular system

Wall
Statuario Slab A/B 320x160 (126"x63") Lap. Ret.

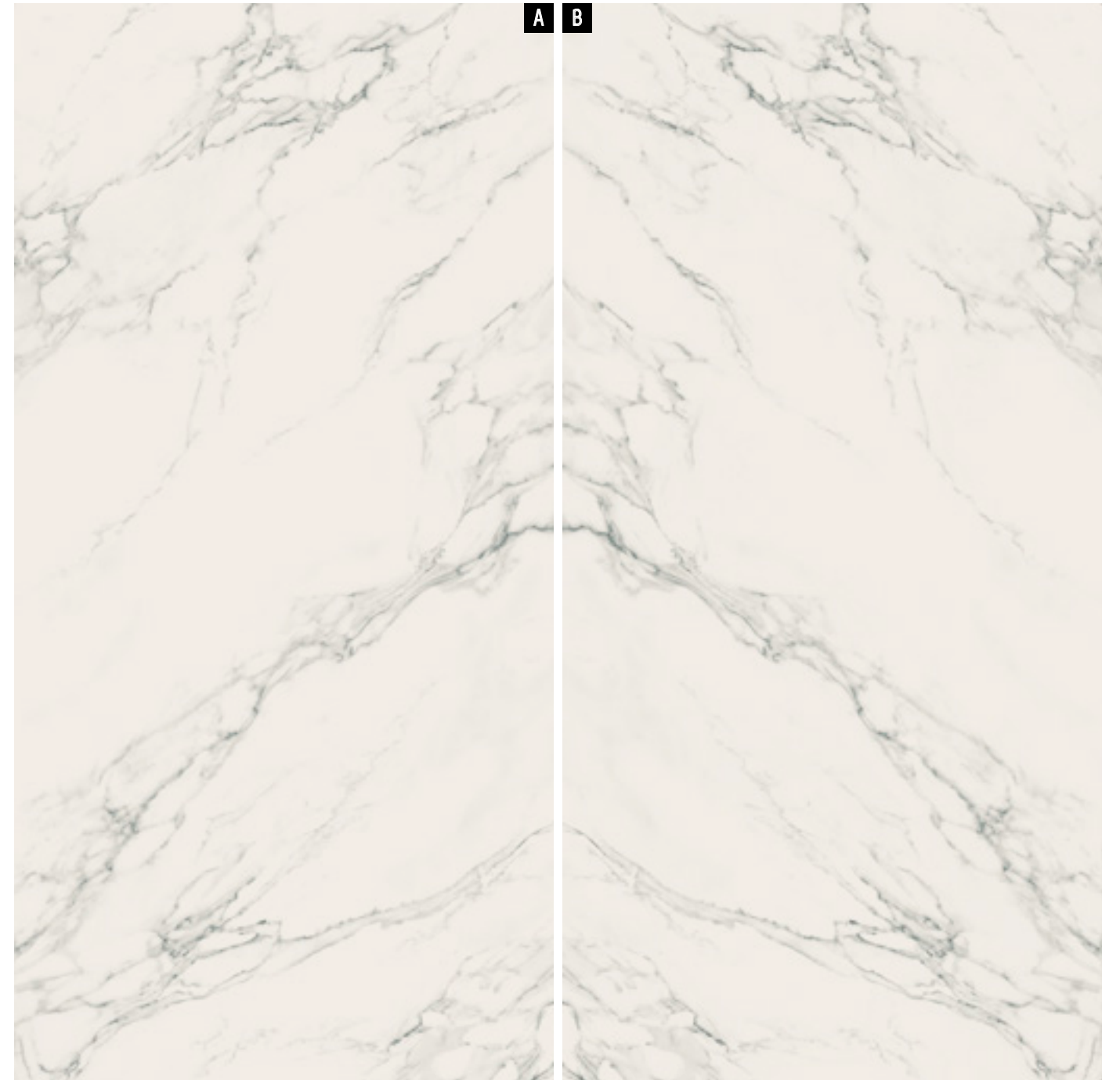

Esempio 1 / Example 1

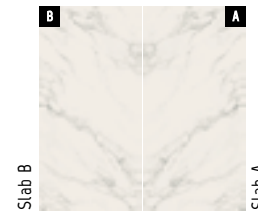

Esempio 2 / Example 2



Esempio 3 / Example 3

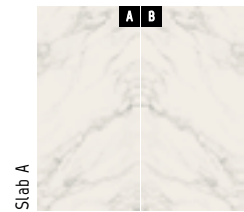

Esempio 4 / Example 4

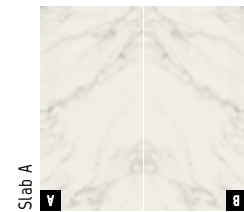

Esempio 5 / Example 5

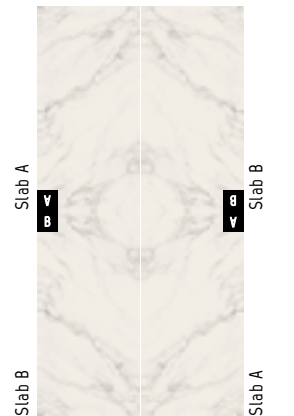









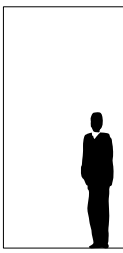

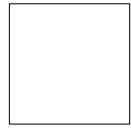











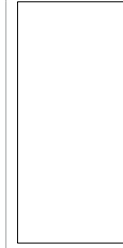
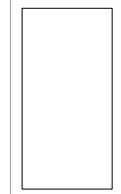

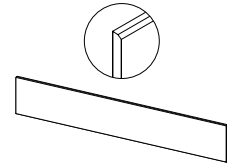
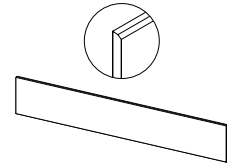
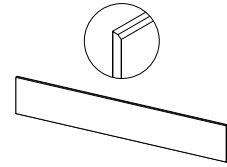
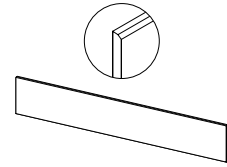
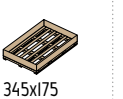





STATUARIO

6 mm

SOLO SUPERFICIE NATURALE
ONLY NATURAL SURFACE

ANSI A - 137.1: 2012
WET DYNAMIC COEFFICIENT OF FRICTION | DCOF ≥ 0,42

	modular system						modular system						Mosaico Mosaic	Slab A/B		Slab A/B		Battiscopa Skirting	Scuretto Rabbeted riser			
																						
	320x160 126"x63" Nat. Ret.	320x160 126"x63" Lap. Ret.	160x160 63"x63" Nat. Ret.	160x160 63"x63" Lap. Ret.	160x80 63"x31 1/2" Nat. Ret.	160x80 63"x31 1/2" Lap. Ret.	80x80 31 1/2"x31 1/2" Nat. Ret.	80x80 31 1/2"x31 1/2" Lap. Ret.	240x120 96"x48" Nat. Ret.	240x120 96"x48" Lap. Ret.	120x120 48"x48" Nat. Ret.	120x120 48"x48" Lap. Ret.	30x30 12"x12" Nat. Ret.	30x30 12"x12" Lap. Ret.	320x160 126"x63" Lap. Ret.	240x120 96"x48" Lap. Ret.	8x80 3"x31 1/2" Nat. Ret.	8x80 3"x31 1/2" Lap. Ret.	20x160 8"x63" Nat. Ret.	20x160 8"x63" Lap. Ret.	20x80 8"x31 1/2" Nat. Ret.	20x80 8"x31 1/2" Lap. Ret.
STATUARIO	083004	083003	083024	083023	083044	083043	083054	083053	083014	083013	083034	083033	083194	083193	083091 A 083092 B	083110 A 083111 B	083204	083203	083224	083223	083234	083233
PREZZO PRICE	€ 106,00 m ²	€ 130,00 m ²	€ 94,00 m ²	€ 120,00 m ²	€ 74,00 m ²	€ 102,00 m ²	€ 62,00 m ²	€ 76,00 m ²	€ 86,00 m ²	€ 108,00 m ²	€ 74,00 m ²	€ 102,00 m ²	€ 126,00 m ²	€ 168,00 m ²	€ 130,00 m ²	€ 108,00 m ²	€ 7,00 PZ/PCE	€ 8,00 PZ/PCE	€ 30,00 PZ/PCE	€ 42,00 PZ/PCE	€ 22,00 PZ/PCE	€ 30,00 PZ/PCE
CODICE PREZZO PRICE CODE	M173	M197	M161	M187	M141	M169	M129	M143	M153	M175	M141	M169	M193	M235	M197	M175	P025	P029	P077	P101	P061	P077
IMBALLO cm h. PACKING cm h.						EPAL 80x120					EPAL 80x120					Pallet 80x120		Pallet 80x120				
Tara / Tare	37	193,5	40,4	193,5	40,9	-	40	153,5	64,7	153,5	-	37	193,5	40	153,5	-	40,9	-	-	-	-	-
N°	14	44	24	88	-	-	20	44	-	88	-	14	44	20	44	-	-	-	-	-	-	-
m ² x	5,12	5,12	2,56	2,56	-	-	2,88	2,88	-	1,44	-	5,12	5,12	2,88	2,88	-	-	-	-	-	-	-
Kg x	74,14	74,14	37,07	37,07	-	-	41,70	41,70	-	20,85	-	74,14	74,14	41,70	41,70	-	-	-	-	-	-	-
m ² x	-	-	-	-	2	3	-	-	2	-	-	-	-	-	-	-	12	1	1	-	-	-
Kg x	-	-	-	-	2,56	1,92	-	-	2,88	-	-	-	-	-	-	-	0,77	-	-	-	-	-
m ² x	-	-	-	-	37,2	27,90	-	-	41,70	-	-	-	-	-	-	-	11,50	5	3	-	-	-
Kg x	-	-	-	-	15	40	-	-	24	-	-	-	-	-	-	-	-	-	-	-	-	-
m ² x	71,68	225,28	61,44	225,28	38,40	76,80	57,60	126,72	69,12	126,72	-	71,68	225,28	57,60	126,72	-	-	-	-	-	-	-
Kg x	1.178	3.472	962	3.472	648	1.141	934	1.993	1.057	1.993	-	1.178	3.472	934	1.993	-	-	-	-	-	-	-



Cavalletto in legno
Wood A-Frame
Support en bois
Holzgestell
Caballete de madera
Деревянная подставка



Cassa
Crate
Caisse
Kiste
Caja
Ящик



Pallet speciale con sponde
Special pallet with sides
Palette spéciale avec bords
Spezial-Palette mit Wandungen
Palet especial con bordes
Специальный поддон с боковинами

STATUARIO

6 mm

SOLO SUPERFICIE NATURALE
ONLY NATURAL SURFACE
ANSI A - 137.1: 2012
WET DYNAMIC COEFFICIENT OF FRICTION
DCOF ≥ 0,42

	Gradino costa retta Straight nosed stair **						Gradino costa retta - Angolo SX / DX Straight-edge step - LH/RH corner **						Gradino Bordo Dritto Straight-edge step **				Gradino Bordo Dritto - Angolo SX / DX Straight-edge step - LH/RH corner **							
	33x160x3,2h 13"x63"x1 1/4"h Nat. Ret.	33x160x3,2h 13"x63"x1 1/4"h Lap. Ret.	33x120x3,2h 13"x48"x1 1/4"h Nat. Ret.	33x120x3,2h 13"x48"x1 1/4"h Lap. Ret.	33x80x3,2h 13"x31 1/2"x1 1/4"h Nat. Ret.	33x80x3,2h 13"x31 1/2"x1 1/4"h Lap. Ret.	33x160x3,2h 13"x63"x1 1/4"h Nat. Ret.	33x160x3,2h 13"x63"x1 1/4"h Lap. Ret.	33x120x3,2h 13"x48"x1 1/4"h Nat. Ret.	33x120x3,2h 13"x48"x1 1/4"h Lap. Ret.	33x80x3,2h 13"x31 1/2"x1 1/4"h Nat. Ret.	33x80x3,2h 13"x31 1/2"x1 1/4"h Lap. Ret.	30x160x4h 12"x63"x1 1/2"h Nat. Ret.	30x160x4h 12"x63"x1 1/2"h Lap. Ret.	30x120x4h 12"x48"x1 1/2"h Nat. Ret.	30x120x4h 12"x48"x1 1/2"h Lap. Ret.	30x80x4h 12"x31 1/2"x1 1/2"h Nat. Ret.	30x80x4h 12"x31 1/2"x1 1/2"h Lap. Ret.	30x160x4h 12"x63"x1 1/2"h Nat. Ret.	30x160x4h 12"x63"x1 1/2"h Lap. Ret.	30x120x4h 12"x48"x1 1/2"h Nat. Ret.	30x120x4h 12"x48"x1 1/2"h Lap. Ret.	30x80x4h 12"x31 1/2"x1 1/2"h Nat. Ret.	30x80x4h 12"x31 1/2"x1 1/2"h Lap. Ret.
STATUARIO	083254	083253	083262	083263	083274	083273	083332 SX 083294 DX	083333 SX 083293 DX	083342 SX 083302 DX	083343 SX 083303 DX	083352 SX 083312 DX	083353 SX 083313 DX	083372	083373	083382	083383	083394	083393	083452 SX 083412 DX	083453 SX 083413 DX	083462 SX 083422 DX	083463 SX 083423 DX	083472 SX 083432 DX	083473 SX 083433 DX
PREZZO PRICE	€ 272,00 PZ/PCE	€ 312,00 PZ/PCE	€ 176,00 PZ/PCE	€ 198,00 PZ/PCE	€ 100,00 PZ/PCE	€ 108,00 PZ/PCE	€ 304,00 PZ/PCE	€ 344,00 PZ/PCE	€ 212,00 PZ/PCE	€ 232,00 PZ/PCE	€ 136,00 PZ/PCE	€ 148,00 PZ/PCE	€ 178,00 PZ/PCE	€ 200,00 PZ/PCE	€ 126,00 PZ/PCE	€ 134,00 PZ/PCE	€ 68,00 PZ/PCE	€ 76,00 PZ/PCE	€ 240,00 PZ/PCE	€ 276,00 PZ/PCE	€ 178,00 PZ/PCE	€ 190,00 PZ/PCE	€ 116,00 PZ/PCE	€ 130,00 PZ/PCE
CODICE PREZZO PRICE CODE	P303	P323	P243	P265	P167	P175	P319	P339	P273	P283	P203	P215	P245	P267	P193	P201	P135	P143	P287	P305	P245	P257	P183	P197
IMBALLO cm h. PACKING cm h.	168x97		Pallet 80x120		Pallet 80x120		168x97		Pallet 80x120		Pallet 80x120		168x97		Pallet 80x120		Pallet 80x120		168x97		Pallet 80x120		Pallet 80x120	
Tara / Tare	-	-	-	-	-	-	-	-	-	-	-	-	-	-	-	-	-	-	-	-	-	-	-	-
x	1	2	2	1	1	1	1	1	1	1	1	1	1	2	2	2	1	1	1	1	1	1	1	1
m ² x	-	-	-	-	-	-	-	-	-	-	-	-	-	-	-	-	-	-	-	-	-	-	-	-
Kg x	9	14	10	10	10	7	10	7	7	6	6	6	8,5	13,5	9	9	9	9,5	9,5	7	7	5	5	
x	-	-	-	-	-	-	-	-	-	-	-	-	-	-	-	-	-	-	-	-	-	-	-	-
m ² x	-	-	-	-	-	-	-	-	-	-	-	-	-	-	-	-	-	-	-	-	-	-	-	-
Kg x	-	-	-	-	-	-	-	-	-	-	-	-	-	-	-	-	-	-	-	-	-	-	-	-



Pallet speciale con sponde
Special pallet with sides
Palette spéciale avec bords
Spezial-Palette mit Wandungen
Palet especial con bordes
Специальный поддон с боковинами











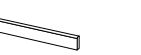
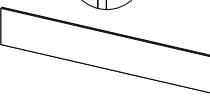
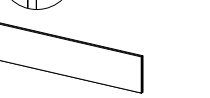
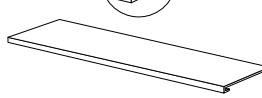
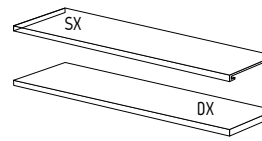
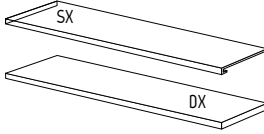
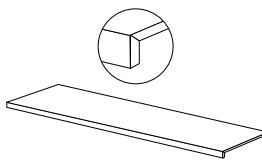
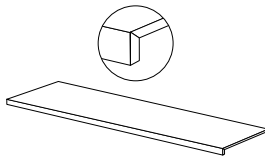
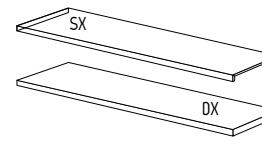
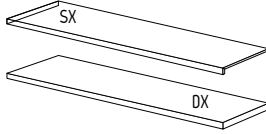

** PEZZI SPECIALI - A disposizione solo su richiesta. Tempi di consegna: 30gg.
TRIMS - Available upon request only. Delivery terms: 30 days.
PIÈCES SPECIALES - Disponible seulement sur requête. Délais de livraison: 30 jours.
FORMSTÜCKE - Verfügbar auf Anfrage. Lieferzeit: 30 Tage.
PIEZAS ESPECIALES - Disponible sólo bajo pedido. Plazo de entrega: 30 días.
СПЕЦИАЛЬНЫЕ ЭЛЕМЕНТЫ - Изготавливается только по специальной заявке. Срок поставки: 30 дней.

STATUARIO INDOOR

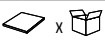
10 mm

SOLO SUPERFICIE NATURALE
ONLY NATURAL SURFACE

ANSI A - 137.1: 2012
WET DYNAMIC COEFFICIENT OF FRICTION | DCOF ≥ 0,42

	modular system				Battiscopa Skirting		Scuretto Rabbeted riser		Gradino costa retta Straight nosed stair **		Gradino costa retta - Angolo SX / DX Straight-edge step - LH/RH corner **		Gradino Bordo Dritto Straight-edge step **		Gradino Bordo Dritto - Angolo SX / DX Straight-edge step - LH/RH corner **	
	 120x60 48"x24" Nat. Ret.	 120x60 48"x24" Lap. Ret.	 60x60 24"x24" Nat. Ret.	 60x60 24"x24" Lap. Ret.	 6,5x120 2 1/2"x48" Lap. Ret.	 6,5x120 2 1/2"x48" Lap. Ret.	 20x120 8"x48" Nat. Ret.	 20x120 8"x48" Lap. Ret.	 33x120x3,2h 13"x48"x1 1/4" Nat. Ret.	 33x120x3,2h 13"x48"x1 1/4" Lap. Ret.	 33x120x3,2h 13"x48"x1 1/4" Nat. Ret.	 33x120x3,2h 13"x48"x1 1/4" Lap. Ret.	 30x120x4h 12"x48"x1 1/2" Nat. Ret.	 30x120x4h 12"x48"x1 1/2" Lap. Ret.	 30x120x4h 12"x48"x1 1/2" Nat. Ret.	 30x120x4h 12"x48"x1 1/2" Lap. Ret.
STATUARIO 	083064	083063	083084	083083	083214	083213	083242	083243	083284	083283	083362 SX 083322 DX	083363 SX 083323 DX	083402	083403	083482 SX 083442 DX	083483 SX 083443 DX
PREZZO PRICE	€ 46,00 m ²	€ 58,00 m ²	€ 36,00 m ²	€ 48,00 m ²	€ 8,00 PZ/PCE	€ 9,00 PZ/PCE	€ 26,00 PZ/PCE	€ 28,00 PZ/PCE	€ 140,00 PZ/PCE	€ 148,00 PZ/PCE	€ 164,00 PZ/PCE	€ 176,00 PZ/PCE	€ 106,00 PZ/PCE	€ 112,00 PZ/PCE	€ 134,00 PZ/PCE	€ 134,00 PZ/PCE
CODICE PREZZO PRICE CODE	M109	M125	M089	M113	P029	P033	P069	P073	P207	P215	P231	P243	P173	P179	P201	P201
	EPAL 80x120		EPAL 80x120		Pallet 80x120		Pallet 80x120		Pallet 80x120		Pallet 80x120		Pallet 80x120		Pallet 80x120	
IMBALLO cm h. PACKING cm h.	-		-		-		-		-		-		-		-	
Tara / Tare	20		20		-		-		-		-		-		-	
 x 	2		3		6		1		2		1		2		1	
m ² x 	1,44		1,08		-		-		-		-		-		-	
Kg x 	33,41		24,80		11,4		12		22		11		22		11	
 x 	30		40		-		-		-		-		-		-	
m ² x 	43,2		43,2		-		-		-		-		-		-	
Kg x 	1.025		1.012		-		-		-		-		-		-	

**

PEZZI SPECIALI - A disposizione solo su richiesta. Tempi di consegna: 30gg.

TRIMS - Available upon request only. Delivery terms: 30 days.

PIÈCES SPECIALES - Disponible seulement sur requête. Délais de livraison: 30 jours.

FORMSTÜCKE - Verfügbar auf Anfrage. Lieferzeit: 30 Tage.

PIEZAS ESPECIALES - Disponible sólo bajo pedido. Plazo de entrega: 30 días.

СПЕЦИАЛЬНЫЕ ЭЛЕМЕНТЫ - Изготавливается только по специальной заявке. Срок поставки: 30 дней.

STATUARIO SPLENDEnte

LASTRE IN GRES PORCELLANATO PRESSATE A SECCO . DRY-PRESSED PORCELAIN STONEWARE SLABS .
DALLES EN GRÈS CÉRAMÉ PRESSÉES À SEC . TROCKENGEPRESSTE PLATTEN AUS FEINSTEINZEUG .
PLANCHAS EN GRÈS PORCELÁNICO PRENSADAS EN SECO . КЕРАМОГРАНИТНЫЕ ПЛИТЫ СУХОГО ПРЕССОВАНИЯ .
UNI EN 14411-ISO 13006 - Appendice C - Gruppo BIa - UGL

100% DESIGN
AND PRODUCTION
OF ITALY

V2
SHADE SPECTRUM
MODERATE

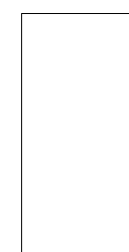

12 mm

324x163 . 127"x64"
Nat.
Lap. Nat.

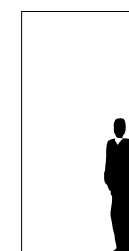

320x160 . 126"x63"
Nat. Ret.
Lap. Ret.

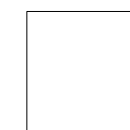

160x160 . 63"x63"
Nat. Ret.
Lap. Ret.



160x80 . 63"x31 1/2"
Nat. Ret.
Lap. Ret.



80x80 . 31 1/2"x31 1/2"
Nat. Ret.
Lap. Ret.



240x120 . 96"x48"
Nat. Ret.
Lap. Ret.



240x80 . 96"x31 1/2"
Lap. Ret.



120x120 . 48"x48"
Nat. Ret.
Lap. Ret.



Mosaico
30x30 . 12"x12"
Nat. Ret.
Lap. Ret.

6 mm

— modular system —

— modular system —

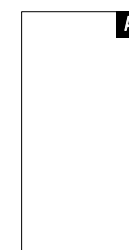

Slab A
320x160 . 126"x63"
Lap. Ret.

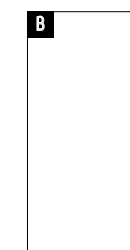

Slab B
320x160 . 126"x63"
Lap. Ret.

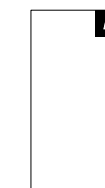

Slab A
240x120 . 96"x48"
Lap. Ret.



Slab B
240x120 . 96"x48"
Lap. Ret.

6 mm

— modular system —

— modular system —

INDOOR



120x60 . 48"x24"
Nat. Ret.
Lap. Ret.



60x60 . 24"x24"
Nat. Ret.
Lap. Ret.

10 mm

— modular system —

SVILUPPO GRAFICO PER FORMATO
Pattern by size
Développement graphique par format
Grafischer Entwurf für Format
Desarrollo gráfico por formato
Варианты графики для каждого формата

320x160
6 mm

320x160
6 mm

160x160
6 mm

160x80
6 mm

80x80
6 mm

240x120
6 mm

240x120
6 mm

240x80
6 mm

120x120
6 mm

120x60
10 mm

60x60
10 mm

324x163
12 mm

7

2
Slab A/B

14

28

56

11

2
Slab A/B

11

22

20

31

1

STATUARIO SPLENDEnte



Wall
Statuario Splendente Slab A/B 320x160 (126"x63") Lap. Ret.

Floor
Statuario Splendente 320x160 (126"x63") Lap. Ret.

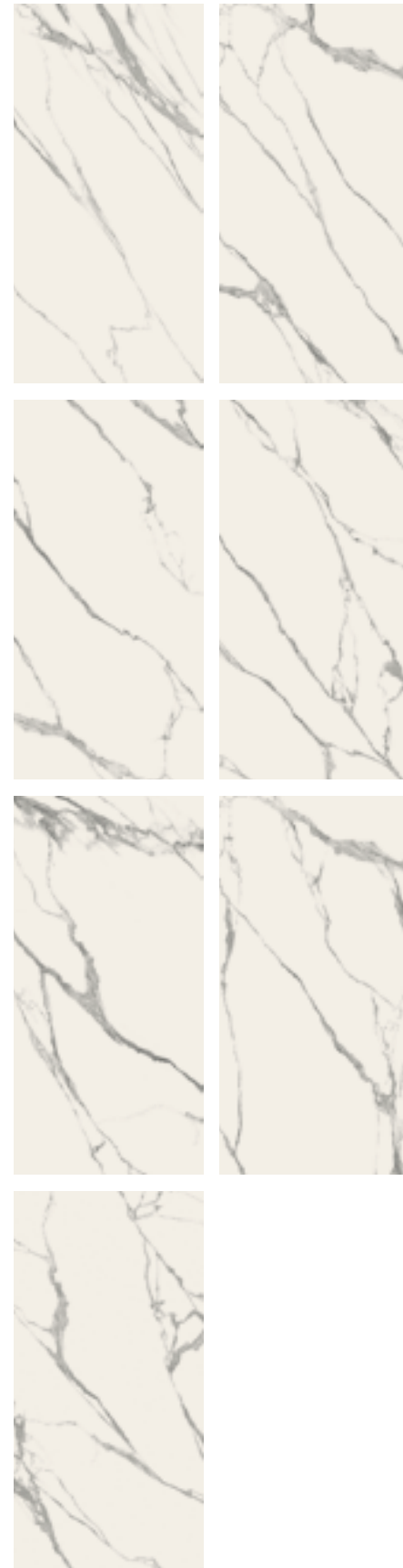
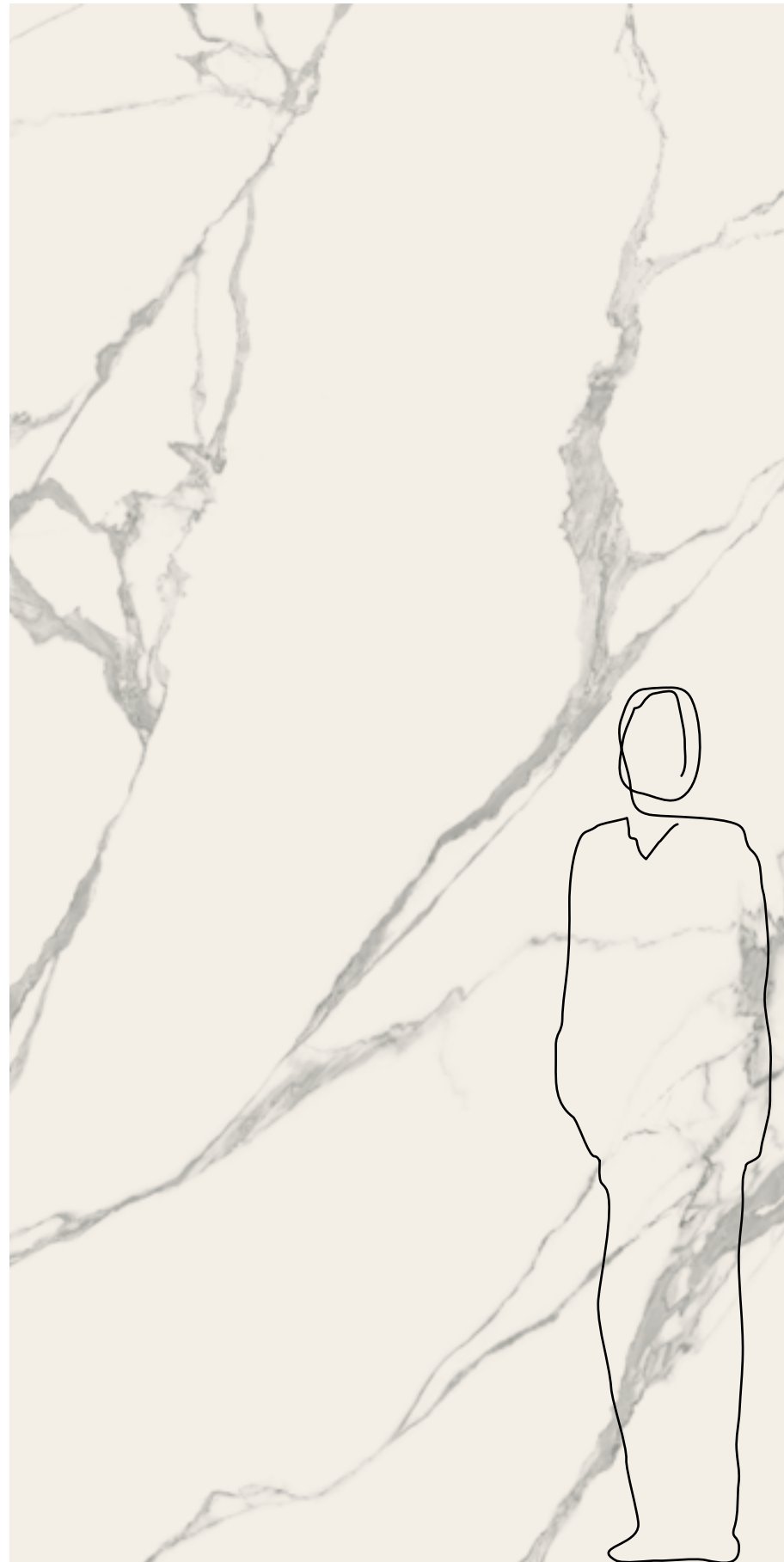

320x160
SVILUPPO GRAFICO PER FORMATO - 7 Pattern by size
 7 Développement graphique par format - 7 Grafischer Entwurf für Format
 7 Desarrollo gráfico por formato - 7 Варианты графики для каждого формата

12 mm

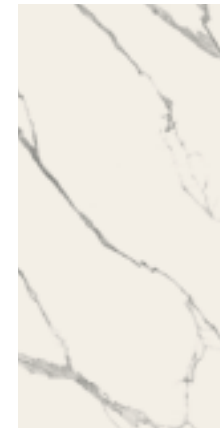

087913
324x163 . 127"x64"
 Nat.
087908
324x163 . 127"x64"
 Lap. Nat.

6 mm



087008
320x160 . 126"x63"
 Nat. Ret.
087007
320x160 . 126"x63"
 Lap. Ret.

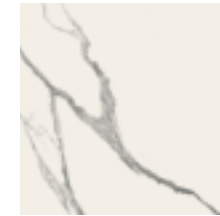

087048
160x160 . 63"x63"
 Nat. Ret.
087047
160x160 . 63"x63"
 Lap. Ret.



087088
160x80 . 63"x31 1/2"
 Nat. Ret.
087087
160x80 . 63"x31 1/2"
 Lap. Ret.



087108
80x80 . 31 1/2"x31 1/2"
 Nat. Ret.
087107
80x80 . 31 1/2"x31 1/2"
 Lap. Ret.

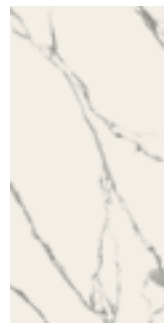

087028
240x120 . 96"x48"
 Nat. Ret.
087027
240x120 . 96"x48"
 Lap. Ret.



087532
240x80 . 96"x31 1/2"
 Lap. Ret.

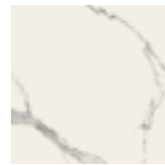

087068
120x120 . 48"x48"
 Nat. Ret.
087067
120x120 . 48"x48"
 Lap. Ret.



Mosaico
087198
30x30 . 12"x12"
 Nat. Ret.
087197
30x30 . 12"x12"
 Lap. Ret.

modular system

modular system

INDOOR

10 mm



087128
120x60 . 48"x24"
 Nat. Ret.
087127
120x60 . 48"x24"
 Lap. Ret.



087148
60x60 . 24"x24"
 Nat. Ret.
087147
60x60 . 24"x24"
 Lap. Ret.

modular system

STATUARIO SPLENDEnte

6 mm

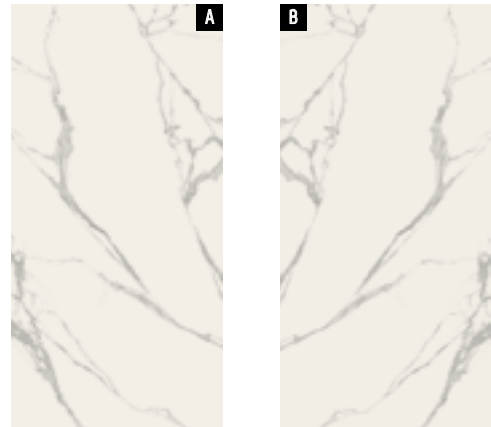

Slab A
087009
320x160 - 126"x63"
Lap. Ret.

Slab B
087011
320x160 - 126"x63"
Lap. Ret.

modular system

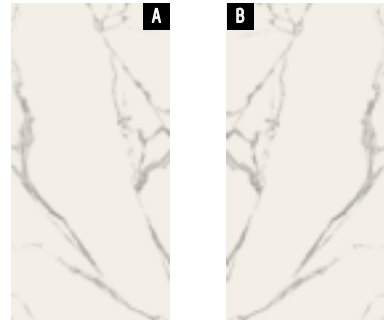

Slab A
087029
240x120 - 96"x48"
Lap. Ret.

Slab B
087031
240x120 - 96"x48"
Lap. Ret.

modular system

Wall
Statuario Splendente Slab A/B 320x160 (126"x63") Lap. Ret.

Floor
Statuario Splendente 320x160 (126"x63") Lap. Ret.

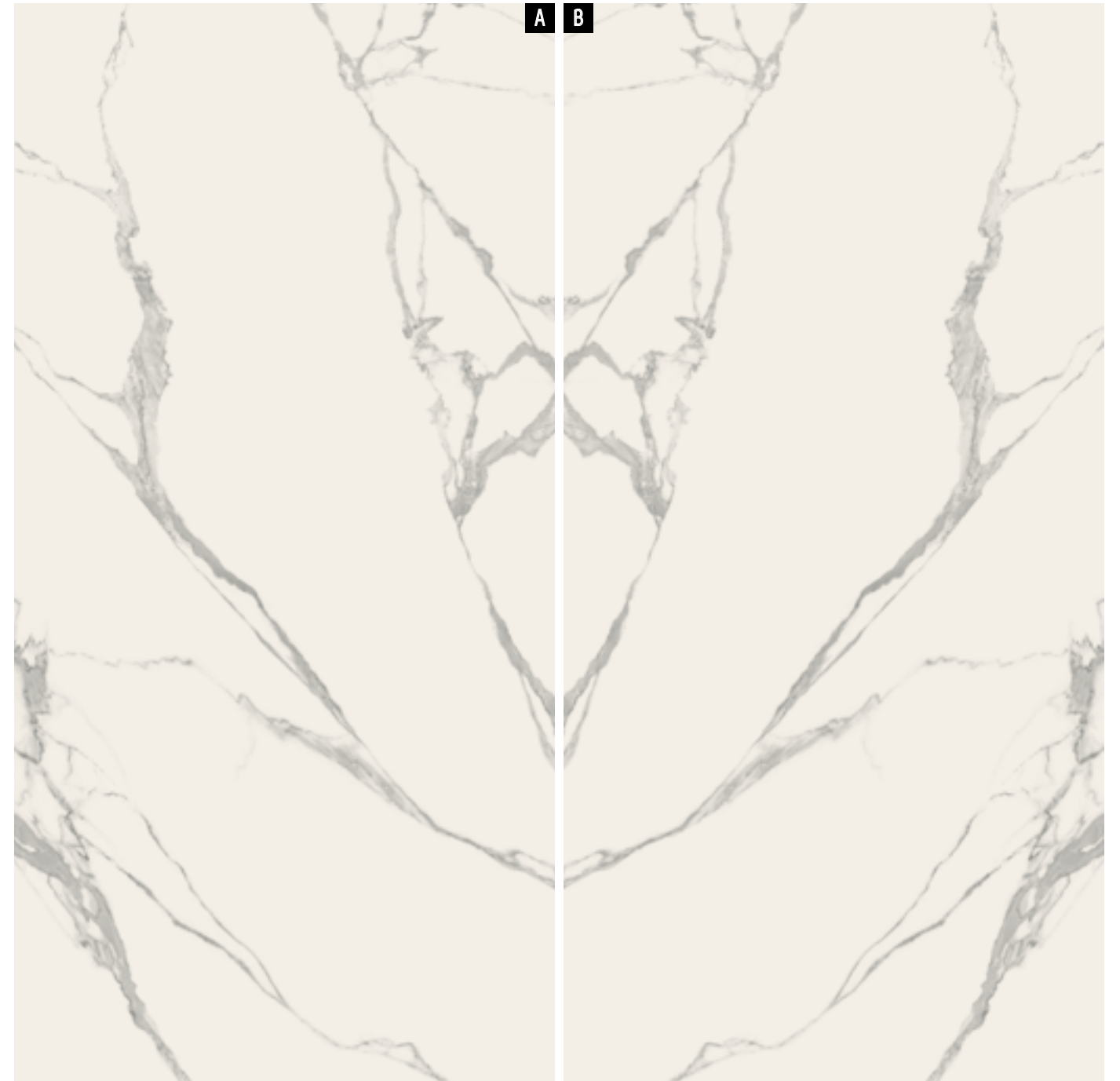

Esempio 1 / Example 1

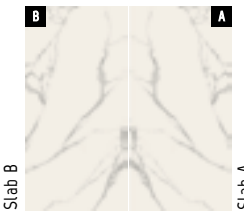

Esempio 2 / Example 2

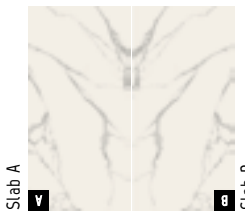

Esempio 3 / Example 3



Esempio 4 / Example 4

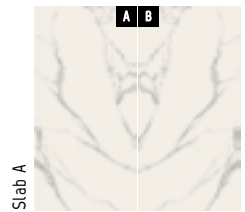

Esempio 5 / Example 5



STATUARIO SPLENDEnte

6 mm

SOLO SUPERFICIE NATURALE ONLY NATURAL SURFACE
ANSI A - 137.1: 2012 WET DYNAMIC COEFFICIENT OF FRICTION DCOF ≥ 0,42

	modular system						modular system						Mosaico Mosaic	Slab A/B		Slab A/B		Battiscopa Skirting	Scuretto Rabbeted riser				
	320x160 126"x63" Nat. Ret.	320x160 126"x63" Lap. Ret.	160x160 63"x63" Nat. Ret.	160x160 63"x63" Lap. Ret.	160x80 63"x31 1/2" Nat. Ret.	160x80 63"x31 1/2" Lap. Ret.	80x80 31 1/2"x31 1/2" Nat. Ret.	80x80 31 1/2"x31 1/2" Lap. Ret.	240x120 96"x48" Nat. Ret.	240x120 96"x48" Lap. Ret.	240x80 96"x31 1/2" Lap. Ret.	120x120 48"x48" Nat. Ret.	120x120 48"x48" Lap. Ret.	30x30 12"x12" Nat. Ret.	30x30 12"x12" Lap. Ret.	320x160 126"x63" Lap. Ret.	240x120 96"x48" Lap. Ret.	8x80 3"x31 1/2" Nat. Ret.	8x80 3"x31 1/2" Lap. Ret.	20x160 8"x63" Nat. Ret.	20x160 8"x63" Lap. Ret.	20x80 8"x31 1/2" Nat. Ret.	20x80 8"x31 1/2" Lap. Ret.
STATUARIO SPLENDEnte	087008	087007	087048	087047	087088	087087	087108	087107	087028	087027	087532	087068	087067	087198	087197	087009 A 087011 B	087029 A 087031 B	087208	087207	087278	087234	087297	087296
PREZZO PRICE	€ 106,00 m ²	€ 130,00 m ²	€ 94,00 m ²	€ 120,00 m ²	€ 74,00 m ²	€ 102,00 m ²	€ 62,00 m ²	€ 76,00 m ²	€ 86,00 m ²	€ 108,00 m ²	€ 108,00 m ²	€ 74,00 m ²	€ 102,00 m ²	€ 126,00 m ²	€ 168,00 m ²	€ 130,00 m ²	€ 108,00 m ²	€ 7,00 PZ/PCE	€ 8,00 PZ/PCE	€ 30,00 PZ/PCE	€ 42,00 PZ/PCE	€ 22,00 PZ/PCE	€ 30,00 PZ/PCE
CODICE PREZZO PRICE CODE	M173	M197	M161	M187	M141	M169	M129	M143	M153	M175	M175	M141	M169	M193	M235	M197	M175	P025	P029	P077	P101	P061	P077
IMBALLO cm h. PACKING cm h.						EPAL 80x120							EPAL 80x120					Pallet 80x120		Pallet 80x120			
Tara / Tare	37	193,5	40,4	193,5	40,9	-	40	153,5	47	153,5	64,7	153,5	-	-	37	193,5	40	153,5	-	40,9	-	-	-
N°	14	44	24	88	-	-	20	44	30	44	-	88	-	-	14	44	20	44	-	-	-	-	-
m ² x	5,12	5,12	2,56	2,56	-	-	2,88	2,88	1,92	1,92	-	1,44	-	-	5,12	5,12	2,88	2,88	-	-	-	-	-
Kg x	74,14	74,14	37,07	37,07	-	-	41,70	41,70	27,80	27,80	-	20,85	-	-	74,14	74,14	41,70	41,70	-	-	-	-	-
m ² x	-	-	-	-	2	3	-	-	-	-	2	-	-	-	-	-	-	-	12	1	-	1	-
Kg x	-	-	-	-	2,56	1,92	-	-	-	-	2,88	-	-	-	-	-	-	-	0,77	-	-	-	-
m ² x	-	-	-	-	37,2	27,90	-	-	-	-	41,70	-	-	-	-	-	-	-	11,50	5	-	3	-
Kg x	-	-	-	-	15	40	-	-	-	-	24	-	-	-	-	-	-	-	-	-	-	-	-
m ² x	71,68	225,28	61,44	225,28	38,40	76,80	57,60	126,72	57,60	84,48	69,12	126,72	-	-	71,68	225,28	57,60	126,72	-	-	-	-	-
Kg x	1.178	3.472	962	3.472	648	1.141	934	1.993	912	1.381	1.057	1.993	-	-	1.178	3.472	934	1.993	-	-	-	-	-



Cavalletto in legno
Wood A-Frame
Support en bois
Holzgestell
Caballete de madera
Деревянная подставка



Cassa
Crate
Caisse
Kiste
Caja
Ящик



Pallet speciale con sponde
Special pallet with sides
Palette spéciale avec bords
Spezial-Palette mit Wandungen
Palet especial con bordes
Специальный поддон с боковинами

STATUARIO SPLENDEnte

6 mm

SOLO SUPERFICIE NATURALE
ONLY NATURAL SURFACE
ANSI A - 137.1: 2012
WET DYNAMIC COEFFICIENT OF FRICTION
DCOF ≥ 0,42

	Gradino costa retta Straight nosed stair **						Gradino costa retta - Angolo SX / DX Straight-edge step - LH/RH corner **						Gradino Bordo Dritto Straight-edge step **				Gradino Bordo Dritto - Angolo SX / DX Straight-edge step - LH/RH corner **							
	33x160x3,2h 13"x63"x1 1/4"h Nat. Ret.	33x160x3,2h 13"x63"x1 1/4"h Lap. Ret.	33x120x3,2h 13"x48"x1 1/4"h Nat. Ret.	33x120x3,2h 13"x48"x1 1/4"h Lap. Ret.	33x80x3,2h 13"x31 1/2"x1 1/4" Nat. Ret.	33x80x3,2h 13"x31 1/2"x1 1/4" Lap. Ret.	33x160x3,2h 13"x63"x1 1/4"h Nat. Ret.	33x160x3,2h 13"x63"x1 1/4"h Lap. Ret.	33x120x3,2h 13"x48"x1 1/4"h Nat. Ret.	33x120x3,2h 13"x48"x1 1/4"h Lap. Ret.	33x80x3,2h 13"x31 1/2"x1 1/4" Nat. Ret.	33x80x3,2h 13"x31 1/2"x1 1/4" Lap. Ret.	30x160x4h 12"x63"x1 1/2"h Nat. Ret.	30x160x4h 12"x63"x1 1/2"h Lap. Ret.	30x120x4h 12"x48"x1 1/2"h Nat. Ret.	30x120x4h 12"x48"x1 1/2"h Lap. Ret.	30x80x4h 12"x31 1/2"x1 1/2"h Nat. Ret.	30x80x4h 12"x31 1/2"x1 1/2"h Lap. Ret.	30x160x4h 12"x63"x1 1/2"h Nat. Ret.	30x160x4h 12"x63"x1 1/2"h Lap. Ret.	30x120x4h 12"x48"x1 1/2"h Nat. Ret.	30x120x4h 12"x48"x1 1/2"h Lap. Ret.	30x80x4h 12"x31 1/2"x1 1/2"h Nat. Ret.	30x80x4h 12"x31 1/2"x1 1/2"h Lap. Ret.
STATUARIO SPLENDEnte	087324	087321	087354	087351	087380	087377	087326 SX 087325 DX	087323 SX 087322 DX	087356 SX 087355 DX	087353 SX 087352 DX	087382 SX 087381 DX	087379 SX 087378 DX	087430	087427	087473	087230	087619	087617	087432 SX 087431 DX	087429 SX 087428 DX	087475 SX 087474 DX	087472 SX 087471 DX	087508 SX 087507 DX	087505 SX 087504 DX
PREZZO PRICE	€ 272,00 PZ/PCE	€ 312,00 PZ/PCE	€ 176,00 PZ/PCE	€ 198,00 PZ/PCE	€ 100,00 PZ/PCE	€ 108,00 PZ/PCE	€ 304,00 PZ/PCE	€ 344,00 PZ/PCE	€ 212,00 PZ/PCE	€ 232,00 PZ/PCE	€ 136,00 PZ/PCE	€ 148,00 PZ/PCE	€ 178,00 PZ/PCE	€ 200,00 PZ/PCE	€ 126,00 PZ/PCE	€ 134,00 PZ/PCE	€ 68,00 PZ/PCE	€ 76,00 PZ/PCE	€ 240,00 PZ/PCE	€ 276,00 PZ/PCE	€ 178,00 PZ/PCE	€ 190,00 PZ/PCE	€ 116,00 PZ/PCE	€ 130,00 PZ/PCE
CODICE PREZZO PRICE CODE	P303	P323	P243	P265	P167	P175	P319	P339	P273	P283	P203	P215	P245	P267	P193	P201	P135	P143	P287	P305	P245	P257	P183	P197
IMBALLO cm h. PACKING cm h.	168x97						168x97						168x97						168x97					
Tara / Tare	-	-	-	-	-	-	-	-	-	-	-	-	-	-	-	-	-	-	-	-	-	-	-	-
	1	2	2	1	1	1	1	1	1	1	1	1	2	2	2	1	1	1	1	1	1	1	1	1
m ² x	-	-	-	-	-	-	-	-	-	-	-	-	-	-	-	-	-	-	-	-	-	-	-	-
Kg x	9	14	10	10	10	7	10	7	7	6	6	8,5	13,5	9	9,5	9,5	7	7	9,5	7	7	5	5	
m ² x	-	-	-	-	-	-	-	-	-	-	-	-	-	-	-	-	-	-	-	-	-	-	-	-
Kg x	-	-	-	-	-	-	-	-	-	-	-	-	-	-	-	-	-	-	-	-	-	-	-	-



Pallet speciale con sponde
Special pallet with sides
Palette spéciale avec bords
Spezial-Palette mit Wandungen
Palet especial con bordes
Специальный поддон с боковинами

** PEZZI SPECIALI - A disposizione solo su richiesta. Tempi di consegna: 30gg.
TRIMS - Available upon request only. Delivery terms: 30 days.
PIÈCES SPECIALES - Disponible seulement sur requête. Délais de livraison: 30 jours.
FORMSTÜCKE - Verfügbar auf Anfrage. Lieferzeit: 30 Tage.
PIEZAS ESPECIALES - Disponible sólo bajo pedido. Plazo de entrega: 30 días.
СПЕЦИАЛЬНЫЕ ЭЛЕМЕНТЫ - Изготавливается только по специальной заявке. Срок поставки: 30 дней.

STATUARIO SPLENDEnte INDOOR

10 mm

modular system

	120x60 48"x24" Nat. Ret.		120x60 48"x24" Lap. Ret.		60x60 24"x24" Nat. Ret.		60x60 24"x24" Lap. Ret.		Battiscopa Skirting		Scuretto Rabbeted riser		Gradino costa retta Straight nosed stair **		Gradino costa retta - Angolo SX / DX Straight-edge step - LH/RH corner **		Gradino Bordo Dritto Straight-edge step **		Gradino Bordo Dritto - Angolo SX / DX Straight-edge step - LH/RH corner **	
STATUARIO SPLENDEnte	087128	087127	087148	087147	087218	087217	087287	087286	087407	087404	087409 SX 087408 DX	087406 SX 087405 DX	087642	087639	087537 SX 087644 DX	087640 SX 087641 DX				
PREZZO PRICE	€ 46,00 m ²	€ 58,00 m ²	€ 36,00 m ²	€ 48,00 m ²	€ 8,00 PZ/PCE	€ 9,00 PZ/PCE	€ 26,00 PZ/PCE	€ 28,00 PZ/PCE	€ 140,00 PZ/PCE	€ 148,00 PZ/PCE	€ 164,00 PZ/PCE	€ 176,00 PZ/PCE	€ 106,00 PZ/PCE	€ 112,00 PZ/PCE	€ 134,00 PZ/PCE	€ 134,00 PZ/PCE				
CODICE PREZZO PRICE CODE	M109	M125	M089	M113	P029	P033	P069	P073	P207	P215	P231	P243	P173	P179	P201	P201				
IMBALLO cm h. PACKING cm h.	EPAL 80x120		EPAL 80x120		Pallet 80x120		Pallet 80x120		Pallet 80x120		Pallet 80x120		Pallet 80x120		Pallet 80x120					
Tara / Tare	20		20		-		-		-		-		-		-					
m ² x	2		3		6		1		2		1		2		1					
Kg x	1,44		1,08		-		-		-		-		-		-					
Kg x	33,41		24,80		11,4		12		22		11		22		11					
m ² x	43,2		43,2		-		-		-		-		-		-					
Kg x	1.025		1.012		-		-		-		-		-		-					

SOLO SUPERFICIE NATURALE
ONLY NATURAL SURFACE

ANSI A - 137.1: 2012
WET DYNAMIC COEFFICIENT OF FRICTION | DCOF ≥ 0,42

12 mm

	324x163 127"x64" Nat.		324x163 127"x64" Lap. Nat.	
STATUARIO SPLENDEnte	087913	087908		
PREZZO PRICE	€ 154,00 m ²	€ 180,00 m ²		
CODICE PREZZO PRICE CODE	M221	M247		
IMBALLO cm h. PACKING cm h.	37		37	
Tara / Tare	150,00		229,00	
N°	10		22	
m ² x	5,28		5,28	
Kg x	152,47		152,47	
m ² x	52,80		116,16	
Kg x	1.674		3.583	

**

PEZZI SPECIALI - A disposizione solo su richiesta. Tempi di consegna: 30gg.

TRIMS - Available upon request only. Delivery terms: 30 days.

PIÈCES SPECIALES - Disponible seulement sur requête. Délais de livraison: 30 jours.

FORMSTÜCKE - Verfügbar auf Anfrage. Lieferzeit: 30 Tage.

PIEZAS ESPECIALES - Disponible sólo bajo pedido. Plazo de entrega: 30 días.

СПЕЦИАЛНЫЕ ЭЛЕМЕНТЫ - Изготавливается только по специальной заявке. Срок поставки: 30 дней.



Cassa
Crate
Caisse
Kiste
Caja
Ящик



Cavalletto in legno
Wood A-Frame
Support en bois
Holzgestell
Caballete de madera
Деревянная подставка



Cavalletto in ferro
Iron A-Frame
Support en fer
Metallgestell
Caballete de hierro
Металлическая подставка

TAJ MAHAL

LASTRE IN GRES PORCELLANATO PRESSATE A SECCO . DRY-PRESSED PORCELAIN STONWARE SLABS .
 DALLES EN GRÈS CÉRAMÉ PRESSÉES À SEC . TROCKENGEPRESSTE PLATTEN AUS FEINSTEINZEUG .
 PLANCHAS EN GRÉS PORCELÁNICO PRENSADAS EN SECO . КЕРАМОГРАНИТНЫЕ ПЛИТЫ СУХОГО ПРЕССОВАНИЯ .
 UNI EN 14411-ISO 13006 - Appendice C - Gruppo BIa - UCL

100% DESIGN
AND PRODUCTION
OF ITALY

V2
SHADE SPECTRUM
MODERATE

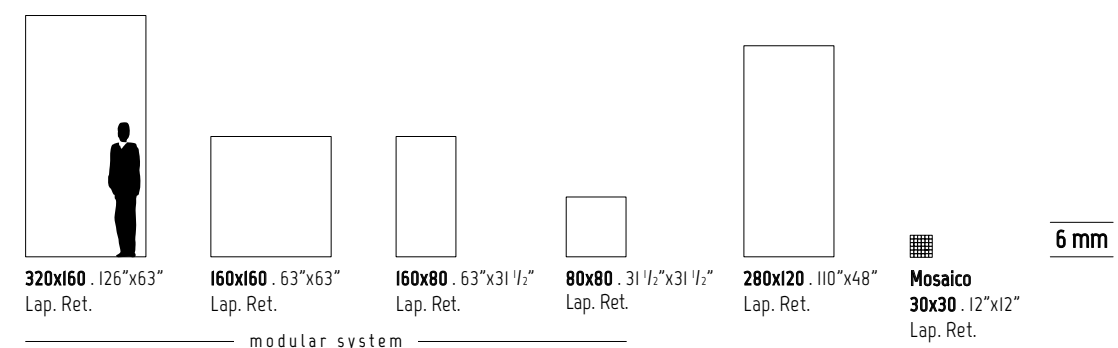

SVILUPPO GRAFICO PER FORMATO
 Pattern by size
 Développement graphique par format
 Grafischer Entwurf für Format
 Desarrollo gráfico por formato
 Варианты графики для каждого формата

320x160 6 mm	160x160 6 mm	160x80 6 mm	80x80 6 mm	280x120 6 mm
7	14	28	56	11

Wall
Taj Mahal 320x160 (126"x63") Lap. Ret.

Floor
Taj Mahal 320x160 (126"x63") Lap. Ret.





320x160
SVILUPPO GRAFICO PER FORMATO - 7 Pattern by size
7 Développement graphique par format - 7 Grafischer Entwurf für Format
7 Desarrollo gráfico por formato - 7 Варианты графики для каждого формата

6 mm



148001
320x160 . 126"x63"
Lap. Ret.

148041
160x160 . 63"x63"
Lap. Ret.

148081
160x80 . 63"x31 1/2"
Lap. Ret.

148101
80x80 . 31 1/2"x31 1/2"
Lap. Ret.

148021
280x120 . 110"x48"
Lap. Ret.

modular system



Mosaico
148281
30x30 . 12"x12"
Lap. Ret.

LA SERIE TAJ MAHAL SI COMPLETA CON ALTRI FORMATI DEL CATALOGO LA FABBRICA MARMO E PIETRA: SERIE MARMÌ
The Taj Mahal series is completed with the other sizes which can be seen in the La Fabbrica Marble & Stone catalogue: Marmi series.
La série Taj Mahal est complétée par d'autres formats du catalogue La Fabbrica Marbres et Pierres : série Marmi.
Die Serie Taj Mahal wird durch andere Formate des Katalogs La Fabbrica Marmore und Steine: Serie Marmi.
La serie Taj Mahal se completa con otros formatos del catálogo La Fabbrica Mármoles y Piedras: serie Marmi.
Серия Taj Mahal дополняется другими форматами из каталога La Fabbrica Мрамор и Камень: серия Marmi.

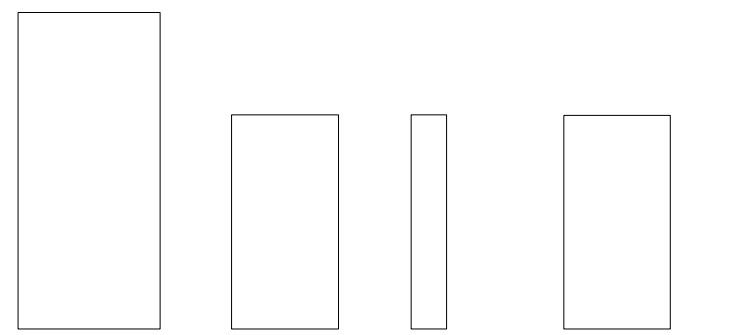

80x180 . 31 1/2"x71"

60x120 . 24"x48"

20x120 . 8"x48"

Jaquard (da rivestimento)
60x120 . 24"x48"

modular system

10 mm RIO-A (naturale)

I VETTORIALI DEI FORMATI NON SONO IN SCALA CON QUELLI DI AVA
The vector images of the sizes shown here are not in scale with the AVA images.
Les vecteurs des formats présentés ici ne sont pas à l'échelle avec ceux d'AVA.
Die Vektorbilder der hier angegebenen Formate sind nicht maßstabsgetreu zu denen von AVA.
Los vectoriales de los formatos aquí indicados no están a escala con aquellos de AVA.
Масштаб векторных изображений указанных здесь форматов не совпадает с масштабом векторных изображений AVA.











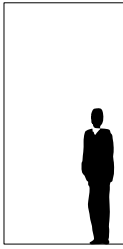
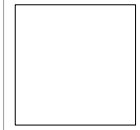

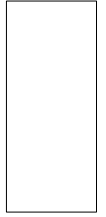

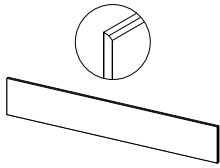
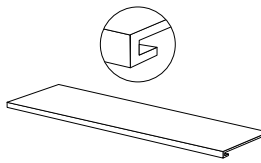
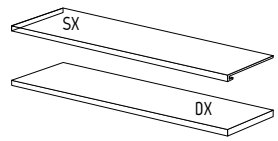
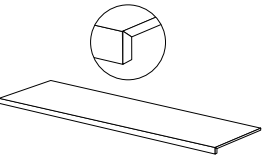
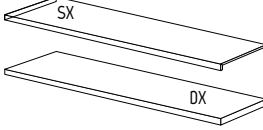











TAJ MAHAL

6 mm

modular system

SOLO SUPERFICIE NATURALE
ONLY NATURAL SURFACE

ANSI A - 137.1: 2012
WET DYNAMIC COEFFICIENT OF FRICTION
DCOF ≥ 0,42

	modular system				Mosaico Mosaic	Battiscopa Skirting	Scuretto Rabbeted riser	Gradino costa retta Straight nosed stair **	Gradino costa retta - Angolo SX / DX Straight-edge step - LH/RH corner **	Gradino Bordo Dritto Straight-edge step **	Gradino Bordo Dritto - Angolo SX / DX Straight-edge step - LH/RH corner **									
																				
	320x160 126"x63" Lap. Ret.	160x160 63"x63" Lap. Ret.	160x80 63"x31 1/2" Lap. Ret.	80x80 31 1/2"x31 1/2" Lap. Ret.	280x120 110"x48" Lap. Ret.	30x30 12"x12" Lap. Ret.	8x80 3"x31 1/2" Lap. Ret.	20x160 8"x63" Lap. Ret.	20x80 8"x31 1/2" Lap. Ret.	33x160x3,2h 13"x63"x1/4" Lap. Ret.	33x80x3,2h 13"x31 1/2"x1/4" Lap. Ret.	33x160x3,2h 13"x63"x1/4" Lap. Ret.	33x80x3,2h 13"x31 1/2"x1/4" Lap. Ret.	30x160x4h 12"x63"x1/2" Lap. Ret.	30x80x4h 12"x31 1/2"x1/2" Lap. Ret.	30x160x4h 12"x63"x1/2" Lap. Ret.	30x80x4h 12"x31 1/2"x1/2" Lap. Ret.			
TAJ MAHAL 	I48001	I48041	I48081	I48101	I48021	I48281	I48201	I48211	I48221	I48231	I48241	I48233 SX I48232 DX	I48243 SX I48242 DX	I48251	I48261	I48253 SX I48252 DX	I48263 SX I48262 DX			
PREZZO PRICE	€ 130,00 m ²	€ 120,00 m ²	€ 102,00 m ²	€ 72,00 m ²	€ 108,00 m ²	€ 168,00 m ²	€ 8,00 PZ/PCE	€ 42,00 PZ/PCE	€ 30,00 PZ/PCE	€ 312,00 PZ/PCE	€ 108,00 PZ/PCE	€ 344,00 PZ/PCE	€ 148,00 PZ/PCE	€ 200,00 PZ/PCE	€ 76,00 PZ/PCE	€ 276,00 PZ/PCE	€ 130,00 PZ/PCE			
CODICE PREZZO PRICE CODE	M197	M187	M169	M139	M175	M235	P029	P101	P077	P323	P175	P339	P215	P267	P143	P305	P197			
						EPAL 80x120			EPAL 80x120	Pallet 80x120		Pallet 80x120		Pallet 80x120		Pallet 80x120		Pallet 80x120		Pallet 80x120
IMBALLO cm h. PACKING cm h.	37	193,5	40,4	193,5	40,9	-	33,8	193,5	-	-	40,9	-	40,9	-	40,9	-	40,9	-	-	-
Tara / Tare	140,00	210,00	71,80	210,00	-	20	108,00	210,00	-	-	-	-	-	-	-	-	-	-	-	-
N°	14	44	24	88	-	-	20	44	-	-	-	-	-	-	-	-	-	-	-	-
m ² x	5,12	5,12	2,56	2,56	-	-	3,36	3,36	-	-	-	-	-	-	-	-	-	-	-	-
Kg x	74,14	74,14	37,07	37,07	-	-	48,65	48,65	-	-	-	-	-	-	-	-	-	-	-	-
 x 	-	-	-	-	2	3	-	-	-	12	1	1	1	2	1	1	1	2	1	1
m ² x 	-	-	-	-	2,56	1,92	-	-	-	0,77	-	-	-	-	-	-	-	-	-	-
Kg x 	-	-	-	-	37,2	27,90	-	-	-	11,50	5	3	9	10	10	6	8,5	9	9,5	5
 x 	-	-	-	-	15	40	-	-	-	-	-	-	-	-	-	-	-	-	-	-
m ² x 	71,68	225,28	61,44	225,28	38,40	76,80	67,2	147,84	-	-	-	-	-	-	-	-	-	-	-	-
Kg x 	1.178	3.472	962	3.472	648	1.141	1.081	2.350	-	-	-	-	-	-	-	-	-	-	-	-



Cavalletto in legno
Wood A-Frame
Support en bois
Holzgestell
Caballete de madera
Деревянная подставка



Cassa
Crate
Caisse
Kiste
Caja
Ящик



Pallet speciale con sponde
Special pallet with sides
Palette spéciale avec bords
Spezial-Palette mit Wandungen
Palet especial con bordes
Специальный поддон с боковинами

** PEZZI SPECIALI - A disposizione solo su richiesta. Tempi di consegna: 30gg.

TRIMS - Available upon request only. Delivery terms: 30 days.

PIÈCES SPECIALES - Disponible seulement sur requête. Délais de livraison: 30 jours.

FORMSTÜCKE - Verfügbar auf Anfrage. Lieferzeit: 30 Tage.

PIEZAS ESPECIALES - Disponible sólo bajo pedido. Plazo de entrega: 30 días.

СПЕЦИАЛЬНЫЕ ЭЛЕМЕНТЫ - Изготавливается только по специальной заявке. Срок поставки: 30 дней.

TORTOISE

LASTRE IN GRES PORCELLANATO PRESSATE A SECCO . DRY-PRESSED PORCELAIN STONEWARE SLABS .
 DALLES EN GRÈS CÉRAMÉ PRESSÉES À SEC . TROCKENGEPRESSTE PLATTEN AUS FEINSTEINZEUG .
 PLANCHAS EN GRES PORCELÁNICO PRENSADAS EN SECO . КЕРАМОГРАНИТНЫЕ ПЛИТЫ СУХОГО ПРЕССОВАНИЯ .
 UNI EN 14411-ISO 13006 - Appendice C - Gruppo BIa - UGL

100% DESIGN
AND PRODUCTION
OF ITALY

V2
SHADE SPECTRUM
MODERATE

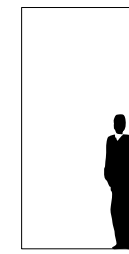

320x160 . 126"x63"
Nat. Ret.

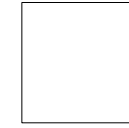

160x160 . 63"x63"
Nat. Ret.



160x80 . 63"x31 1/2"
Nat. Ret.



80x80 . 31 1/2"x31 1/2"
Nat. Ret.



280x120 . 110"x48"
Nat. Ret.



Mosaico
30x30 . 12"x12"
Nat. Ret.

6 mm

modular system

SVILUPPO GRAFICO PER FORMATO
 Pattern by size
 Développement graphique par format
 Grafischer Entwurf für Format
 Desarrollo gráfico por formato
 Варианты графики для каждого формата

	320x160 6 mm	160x160 6 mm	160x80 6 mm	80x80 6 mm	280x120 6 mm
	7	14	28	56	11



Floor
Tortoise 80x80 (31 1/2"x31 1/2") Nat. Ret.

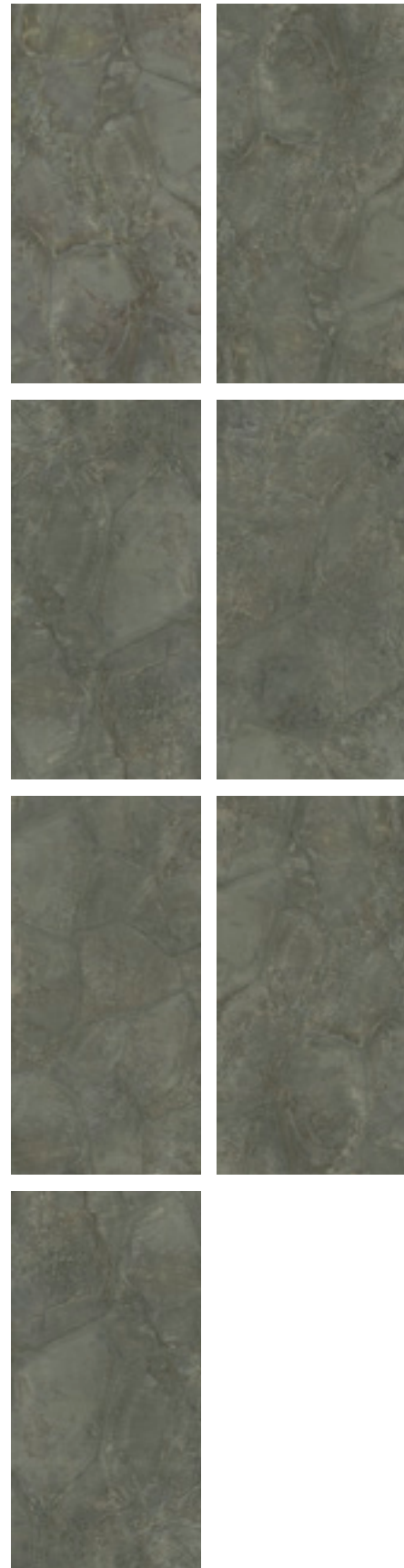

320x160
 SVILUPPO GRAFICO PER FORMATO - 7 Pattern by size
 7 Développement graphique par format - 7 Grafischer Entwurf für Format
 7 Desarrollo gráfico por formato - 7 Варианты графики для каждого формата

6 mm



139001
320x160 . 126"x63"
 Nat. Ret.

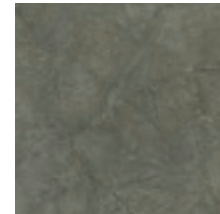

139041
160x160 . 63"x63"
 Nat. Ret.



139081
160x80 . 63"x31 1/2"
 Nat. Ret.



139101
80x80 . 31 1/2"x31 1/2"
 Nat. Ret.



139021
280x120 . 110"x48"
 Nat. Ret.



Mosaico
139301
30x30 . 12"x12"
 Nat. Ret.

modular system

TORTOISE

6 mm

modular system

ANSI A - 137.1: 2012
WET DYNAMIC COEFFICIENT OF FRICTION | DCOF ≥ 0,42

	modular system				Mosaico Mosaic	Battiscopa Skirting	Scuretto Rabbeted riser	Gradino costa retta Straight nosed stair **		Gradino costa retta - Angolo SX / DX Straight-edge step - LH/RH corner **		Gradino Bordo Dritto Straight-edge step **		Gradino Bordo Dritto - Angolo SX / DX Straight-edge step - LH/RH corner **					
	320x160 126"x63" Nat. Ret.	160x160 63"x63" Nat. Ret.	160x80 63"x31 1/2" Nat. Ret.	80x80 31 1/2"x31 1/2" Nat. Ret.	280x120 110"x48" Nat. Ret.	30x30 12"x12" Nat. Ret.	8x80 3"x31 1/2" Nat. Ret.	20x160 8"x63" Nat. Ret.	20x80 8"x31 1/2" Nat. Ret.	33x160x3,2h 13"x63"x1/4"h Nat. Ret.	33x80x3,2h 13"x31 1/2"x1/4"h Nat. Ret.	33x160x3,2h 13"x63"x1/4"h Nat. Ret.	33x80x3,2h 13"x31 1/2"x1/4"h Nat. Ret.	30x160x4h 12"x63"x1/2"h Nat. Ret.	30x80x4h 12"x31 1/2"x1/2"h Nat. Ret.	30x160x4h 12"x63"x1/2"h Nat. Ret.	30x80x4h 12"x31 1/2"x1/2"h Nat. Ret.		
TORTOISE	I39001	I39041	I39081	I39101	I39021	I39301	I39201	I39251	I39261	I39401	I39404	I39403 SX I39402 DX	I39406 SX I39405 DX	I39407	I39410	I39409 SX I39408 DX	I39412 SX I39411 DX		
PREZZO PRICE	€ 106,00 m ²	€ 94,00 m ²	€ 74,00 m ²	€ 76,00 m ²	€ 86,00 m ²	€ 126,00 m ²	€ 7,00 PZ/PCE	€ 30,00 PZ/PCE	€ 22,00 PZ/PCE	€ 272,00 PZ/PCE	€ 100,00 PZ/PCE	€ 304,00 PZ/PCE	€ 136,00 PZ/PCE	€ 178,00 PZ/PCE	€ 68,00 PZ/PCE	€ 240,00 PZ/PCE	€ 116,00 PZ/PCE		
CODICE PREZZO PRICE CODE	M173	M161	M141	M143	M153	M193	P025	P077	P061	P303	P167	P319	P203	P245	P135	P287	P183		
IMBALLO cm h. PACKING cm h.	 345x175	 330x75	 182,6x173,6	 330x75	 168x97	EPAL 80x120	 302x136	 330x75	EPAL 80x120	Pallet 80x120	 168x97	Pallet 80x120	 168x97	Pallet 80x120	 168x97	Pallet 80x120	 168x97	Pallet 80x120	
Tara / Tare	140,00	210,00	71,80	210,00	-	20	108,00	210,00	-	-	-	-	-	-	-	-	-	-	
N°	14	44	24	88	-	-	20	44	-	-	-	-	-	-	-	-	-	-	
m ² x	5,12	5,12	2,56	2,56	-	-	3,36	3,36	-	-	-	-	-	-	-	-	-	-	
Kg x	74,14	74,14	37,07	37,07	-	-	48,65	48,65	-	-	-	-	-	-	-	-	-	-	
x	-	-	-	-	2	3	-	-	-	1	1	1	2	1	1	1	2	1	1
m ² x	-	-	-	-	2,56	1,92	-	-	-	-	-	-	-	-	-	-	-	-	-
Kg x	-	-	-	-	37,2	27,90	-	-	-	5	3	9	10	10	6	8,5	9	9,5	5
x	-	-	-	-	15	40	-	-	-	-	-	-	-	-	-	-	-	-	-
m ² x	71,68	225,28	61,44	225,28	38,40	76,80	67,2	147,84	-	-	-	-	-	-	-	-	-	-	-
Kg x	1.178	3.472	962	3.472	648	1.141	1.081	2.350	-	-	-	-	-	-	-	-	-	-	-



Cavalletto in legno
Wood A-Frame
Support en bois
Holzgestell
Caballette de madera
Деревянная подставка



Cassa
Crate
Caisse
Kiste
Caja
Ящик



Pallet speciale con sponde
Special pallet with sides
Palette spéciale avec bords
Spezial-Palette mit Wandungen
Palet especial con bordes
Специальный поддон с боковинами

** PEZZI SPECIALI - A disposizione solo su richiesta. Tempi di consegna: 30gg.
TRIMS - Available upon request only. Delivery terms: 30 days.
PIÈCES SPECIALES - Disponible seulement sur requête. Délais de livraison: 30 jours.
FORMSTÜCKE - Verfügbar auf Anfrage. Lieferzeit: 30 Tage.
PIEZAS ESPECIALES - Disponible sólo bajo pedido. Plazo de entrega: 30 días.
СПЕЦИАЛЬНЫЕ ЭЛЕМЕНТЫ - Изготавливается только по специальной заявке. Срок поставки: 30 дней.

TRAVERTINO CLASSIC

LASTRE IN GRES PORCELLANATO PRESSATE A SECCO . DRY-PRESSED PORCELAIN STONEWARE SLABS .
 DALLES EN GRÈS CÉRAMÉ PRESSÉES À SEC . TROCKENGEPRESSTE PLATTEN AUS FEINSTEINZEUG .
 PLANCHAS EN GRÉS PORCELÁNICO PRENSADAS EN SECO . КЕРАМОГРАНИТНЫЕ ПЛИТЫ СУХОГО ПРЕССОВАНИЯ .
 UNI EN 14411-ISO 13006 - Appendice C - Gruppo BIa - UCL

100% DESIGN
AND PRODUCTION
OF ITALY

V2
SHADE SPECTRUM
MODERATE

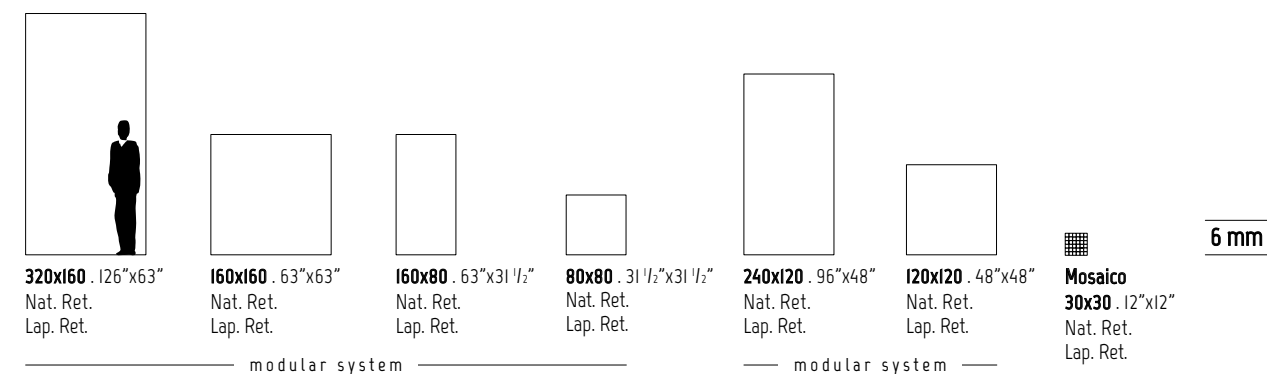

INDOOR

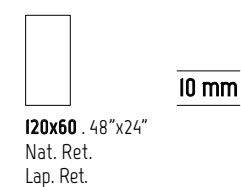

SVILUPPO GRAFICO PER FORMATO Pattern by size Développement graphique par format Grafischer Entwurf für Format Desarrollo gráfico por formato Варианты графики для каждого формата	320x160 6 mm	160x160 6 mm	160x80 6 mm	80x80 6 mm	240x120 6 mm	120x120 6 mm	120x60 10 mm
	7	14	28	56	11	22	12

TRAVERTINO CLASSIC



Wall
Travertino Classic 320x160 (126"x63") Lap. Ret.

Floor
Travertino Classic 320x160 (126"x63") Lap. Ret.



320x160
SVILUPPO GRAFICO PER FORMATO - 7 Pattern by size
 7 Développement graphique par format - 7 Grafischer Entwurf für Format
 7 Desarrollo gráfico por formato - 7 Варианты графики для каждого формата

6 mm



I38002
320x160 . 126"x63"
 Nat. Ret.

I38001
320x160 . 126"x63"
 Lap. Ret.



I38006
160x160 . 63"x63"
 Nat. Ret.

I38005
160x160 . 63"x63"
 Lap. Ret.



I38010
160x80 . 63"x31 1/2"
 Nat. Ret.

I38009
160x80 . 63"x31 1/2"
 Lap. Ret.



I38012
80x80 . 31 1/2"x31 1/2"
 Nat. Ret.

I38011
80x80 . 31 1/2"x31 1/2"
 Lap. Ret.



I38004
240x120 . 96"x48"
 Nat. Ret.

I38003
240x120 . 96"x48"
 Lap. Ret.



I38008
120x120 . 48"x48"
 Nat. Ret.

I38007
120x120 . 48"x48"
 Lap. Ret.



Mosaico
I38202
30x30 . 12"x12"
 Nat. Ret.

I38201
30x30 . 12"x12"
 Lap. Ret.

modular system

modular system

INDOOR

10 mm



I38014
120x60 . 48"x24"
 Nat. Ret.

I38013
120x60 . 48"x24"
 Lap. Ret.











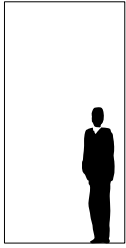

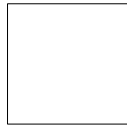

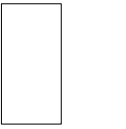
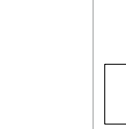

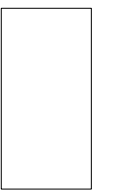
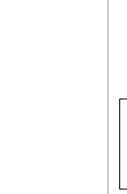

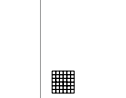

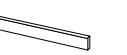

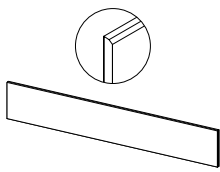
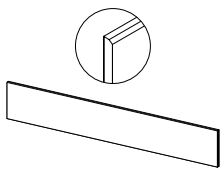
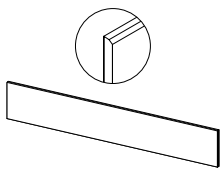
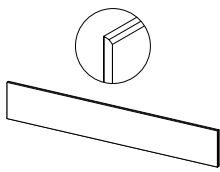









TRAVERTINO CLASSIC

6 mm

SOLO SUPERFICIE NATURALE
ONLY NATURAL SURFACE

ANSI A - 137.1: 2012
WET DYNAMIC COEFFICIENT OF FRICTION

DCOF ≥ 0,42

	modular system								modular system				Mosaico Mosaic	Battiscopa Skirting	Scuretto Rabbeted riser						
																					
	320x160 126"x63" Nat. Ret.	320x160 126"x63" Lap. Ret.	160x160 63"x63" Nat. Ret.	160x160 63"x63" Lap. Ret.	160x80 63"x31 1/2" Nat. Ret.	160x80 63"x31 1/2" Lap. Ret.	80x80 31 1/2"x31 1/2" Nat. Ret.	80x80 31 1/2"x31 1/2" Lap. Ret.	240x120 96"x48" Nat. Ret.	240x120 96"x48" Lap. Ret.	120x120 48"x48" Nat. Ret.	120x120 48"x48" Lap. Ret.	30x30 12"x12" Nat. Ret.	30x30 12"x12" Lap. Ret.	8x80 3"x31 1/2" Nat. Ret.	8x80 3"x31 1/2" Lap. Ret.	20x160 8"x63" Nat. Ret.	20x160 8"x63" Lap. Ret.	20x80 8"x31 1/2" Nat. Ret.	20x80 8"x31 1/2" Lap. Ret.	
TRAVERTINO CLASSIC		I38002	I38001	I38006	I38005	I38010	I38009	I38012	I38011	I38004	I38003	I38008	I38007	I38202	I38201	I38101	I38102	I38106	I38105	I38110	I38109
PREZZO PRICE	€ 106,00 m ²	€ 130,00 m ²	€ 94,00 m ²	€ 120,00 m ²	€ 74,00 m ²	€ 102,00 m ²	€ 62,00 m ²	€ 76,00 m ²	€ 86,00 m ²	€ 108,00 m ²	€ 74,00 m ²	€ 102,00 m ²	€ 126,00 m ²	€ 168,00 m ²	€ 7,00 PZ/PCE	€ 8,00 PZ/PCE	€ 30,00 PZ/PCE	€ 42,00 PZ/PCE	€ 22,00 PZ/PCE	€ 30,00 PZ/PCE	
CODICE PREZZO PRICE CODE	M173	M197	M161	M187	M141	M169	M129	M143	M153	M175	M141	M169	M193	M235	P025	P029	P077	P101	P061	P077	
IMBALLO cm h. PACKING cm h.	 345x175	 330x75	 182,6x173,6	 330x75	 168x97	EPAL 80x120		 264x136,6  250x75		 143x123	 250x75	EPAL 80x120		Pallet 80x120		 168x97		Pallet 80x120			
Tara / Tare	140,00	210,00	71,80	210,00	-	20		100,00		158,00	-	158,00	-	-	-	-	-	-	-	-	
N°	14	44	24	88	-	-		20		44	-	88	-	-	-	-	-	-	-	-	
m ² x	5,12	5,12	2,56	2,56	-	-		2,88		2,88	-	1,44	-	-	-	-	-	-	-	-	
Kg x	74,14	74,14	37,07	37,07	-	-		41,70		41,70	-	20,85	-	-	-	-	-	-	-	-	
 x 	-	-	-	-	2	3		-		-	2	-	-	-	12	-	1	-	1		
m ² x 	-	-	-	-	2,56	1,92		-		-	-	2,88	-	-	0,77	-	-	-	-		
Kg x 	-	-	-	-	37,2	27,90		-		-	-	41,70	-	-	11,50	-	5	-	3		
 x 	-	-	-	-	15	40		-		-	-	24	-	-	-	-	-	-	-		
m ² x 	71,68	225,28	61,44	225,28	38,40	76,80		57,60		126,72	69,12	126,72	-	-	-	-	-	-	-		
Kg x 	1.178	3.472	962	3.472	648	1.141		934		1.993	1.057	1.993	-	-	-	-	-	-	-		



Cavalletto in legno
Wood A-Frame
Support en bois
Holzgestell
Caballete de madera
Деревянная подставка



Cassa
Crate
Caisse
Kiste
Caja
Ящик



Pallet speciale con sponde
Special pallet with sides
Palette spéciale avec bords
Spezial-Palette mit Wandungen
Palet especial con bordes
Специальный поддон с боковинами

TRAVERTINO CLASSIC

6 mm

SOLO SUPERFICIE NATURALE ONLY NATURAL SURFACE ANSI A - 137.1: 2012 WET DYNAMIC COEFFICIENT OF FRICTION DCOF ≥ 0,42

	Gradino costa retta Straight nosed stair **						Gradino costa retta - Angolo SX / DX Straight-edge step - LH/RH corner **						Gradino Bordo Dritto Straight-edge step **						Gradino Bordo Dritto - Angolo SX / DX Straight-edge step - LH/RH corner **																	
	33x160x3,2h 13"x63"x1 1/4"h Nat. Ret.		33x160x3,2h 13"x63"x1 1/4"h Lap. Ret.		33x120x3,2h 13"x48"x1 1/4"h Nat. Ret.		33x120x3,2h 13"x48"x1 1/4"h Lap. Ret.		33x80x3,2h 13"x31 1/2"x1 1/4"h Nat. Ret.		33x80x3,2h 13"x31 1/2"x1 1/4"h Lap. Ret.		30x160x4h 12"x63"x1 1/2"h Nat. Ret.		30x160x4h 12"x63"x1 1/2"h Lap. Ret.		30x120x4h 12"x48"x1 1/2"h Nat. Ret.		30x120x4h 12"x48"x1 1/2"h Lap. Ret.		30x80x4h 12"x31 1/2"x1 1/2"h Nat. Ret.		30x80x4h 12"x31 1/2"x1 1/2"h Lap. Ret.		30x160x4h 12"x63"x1 1/2"h Nat. Ret.		30x160x4h 12"x63"x1 1/2"h Lap. Ret.		30x120x4h 12"x48"x1 1/2"h Nat. Ret.		30x120x4h 12"x48"x1 1/2"h Lap. Ret.		30x80x4h 12"x31 1/2"x1 1/2"h Nat. Ret.		30x80x4h 12"x31 1/2"x1 1/2"h Lap. Ret.	
TRAVERTINO CLASSIC	I38114	I38111	I38120	I38117	I38126	I38123	I38116 SX I38115 DX	I38113 SX I38112 DX	I38122 SX I38121 DX	I38119 SX I38118 DX	I38128 SX I38127 DX	I38125 SX I38124 DX	I38138	I38135	I38144	I38141	I38150	I38147	I38140 SX I38139 DX	I38137 SX I38136 DX	I38146 SX I38145 DX	I38143 SX I38142 DX	I38152 SX I38151 DX	I38149 SX I38148 DX	I38138	I38135	I38144	I38141	I38150	I38147	I38140 SX I38139 DX	I38137 SX I38136 DX	I38146 SX I38145 DX	I38143 SX I38142 DX	I38152 SX I38151 DX	I38149 SX I38148 DX
PREZZO PRICE	€ 272,00 PZ/PCE	€ 312,00 PZ/PCE	€ 176,00 PZ/PCE	€ 198,00 PZ/PCE	€ 100,00 PZ/PCE	€ 108,00 PZ/PCE	€ 304,00 PZ/PCE	€ 344,00 PZ/PCE	€ 212,00 PZ/PCE	€ 232,00 PZ/PCE	€ 136,00 PZ/PCE	€ 148,00 PZ/PCE	€ 178,00 PZ/PCE	€ 200,00 PZ/PCE	€ 126,00 PZ/PCE	€ 134,00 PZ/PCE	€ 68,00 PZ/PCE	€ 76,00 PZ/PCE	€ 240,00 PZ/PCE	€ 276,00 PZ/PCE	€ 178,00 PZ/PCE	€ 190,00 PZ/PCE	€ 116,00 PZ/PCE	€ 130,00 PZ/PCE	€ 178,00 PZ/PCE	€ 200,00 PZ/PCE	€ 126,00 PZ/PCE	€ 134,00 PZ/PCE	€ 68,00 PZ/PCE	€ 76,00 PZ/PCE	€ 240,00 PZ/PCE	€ 276,00 PZ/PCE	€ 178,00 PZ/PCE	€ 190,00 PZ/PCE	€ 116,00 PZ/PCE	€ 130,00 PZ/PCE
CODICE PREZZO PRICE CODE	P303	P323	P243	P265	P167	P175	P319	P339	P273	P283	P203	P215	P245	P267	P193	P201	P135	P143	P287	P305	P245	P257	P183	P197	P245	P267	P193	P201	P135	P143	P287	P305	P245	P257	P183	P197
IMBALLO cm h. PACKING cm h.	168x97		Pallet 80x120		Pallet 80x120		168x97		Pallet 80x120		Pallet 80x120		168x97		Pallet 80x120		Pallet 80x120		168x97		Pallet 80x120		Pallet 80x120		168x97		Pallet 80x120		Pallet 80x120		Pallet 80x120		Pallet 80x120			
Tara / Tare	-		-		-		-		-		-		-		-		-		-		-		-		-		-		-		-		-		-	
	1	2	2	1	1	1	1	1	1	1	1	1	1	2	2	1	1	1	1	1	1	1	1	1	1	1	2	2	1	1	1	1	1	1		
m ² x	-	-	-	-	-	-	-	-	-	-	-	-	-	-	-	-	-	-	-	-	-	-	-	-	-	-	-	-	-	-	-	-	-	-		
Kg x	9	14	10	10	7	6	10	7	6	6	6	6	8,5	13,5	9	9,5	9,5	7	5	7	5	5	5	7	5	7	5	5	5	5	5	5	5	5		
m ² x	-	-	-	-	-	-	-	-	-	-	-	-	-	-	-	-	-	-	-	-	-	-	-	-	-	-	-	-	-	-	-	-	-	-		
Kg x	-	-	-	-	-	-	-	-	-	-	-	-	-	-	-	-	-	-	-	-	-	-	-	-	-	-	-	-	-	-	-	-	-	-		















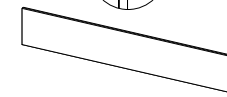
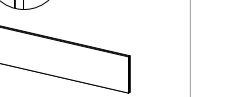
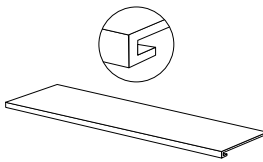
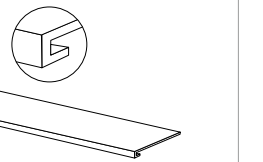
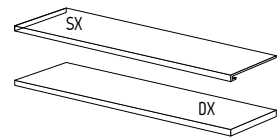
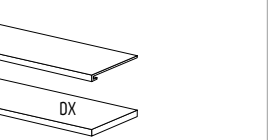
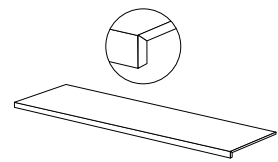
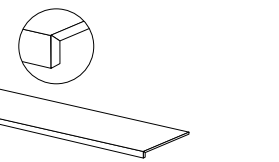
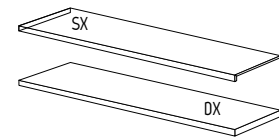
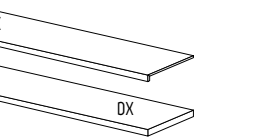

Pallet speciale con sponde
Special pallet with sides
Palette spéciale avec bords
Spezial-Palette mit Wandungen
Palet especial con bordes
Специальный поддон с боковинами

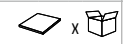
** PEZZI SPECIALI - A disposizione solo su richiesta. Tempi di consegna: 30gg.
TRIMS - Available upon request only. Delivery terms: 30 days.
PIÈCES SPECIALES - Disponible seulement sur requête. Délais de livraison: 30 jours.
FORMSTÜCKE - Verfügbar auf Anfrage. Lieferzeit: 30 Tage.
PIEZAS ESPECIALES - Disponible sólo bajo pedido. Plazo de entrega: 30 días.
СПЕЦИАЛЬНЫЕ ЭЛЕМЕНТЫ - Изготавливается только по специальной заявке. Срок поставки: 30 дней.

TRAVERTINO CLASSIC INDOOR

10 mm

SOLO SUPERFICIE NATURALE ONLY NATURAL SURFACE
ANSI A - 137.1: 2012 WET DYNAMIC COEFFICIENT OF FRICTION DCOF ≥ 0,42

	Battiscopa Skirting		Scuretto Rabbeted riser		Gradino costa retta Straight nosed stair **		Gradino costa retta - Angolo SX / DX Straight-edge step - LH/RH corner **		Gradino Bordo Dritto Straight-edge step **		Gradino Bordo Dritto - Angolo SX / DX Straight-edge step - LH/RH corner **			
	 120x60 48"x24" Nat. Ret.	 120x60 48"x24" Lap. Ret.	 6,5x120 2 1/2"x48" Nat. Ret.	 6,5x120 2 1/2"x48" Lap. Ret.	 20x120 8"x48" Nat. Ret.	 20x120 8"x48" Lap. Ret.	 33x120x3,2h 13"x48"x1 1/4" Nat. Ret.	 33x120x3,2h 13"x48"x1 1/4" Lap. Ret.	 33x120x3,2h 13"x48"x1 1/4" Nat. Ret.	 33x120x3,2h 13"x48"x1 1/4" Lap. Ret.	 30x120x4h 12"x48"x1 1/2" Nat. Ret.	 30x120x4h 12"x48"x1 1/2" Lap. Ret.	 30x120x4h 12"x48"x1 1/2" Nat. Ret.	 30x120x4h 12"x48"x1 1/2" Lap. Ret.
TRAVERTINO CLASSIC 	I38014	I38013	I38104	I38103	I38107	I38108	I38132	I38129	I38134 SX I38133 DX	I38131 SX I38130 DX	I38156	I38153	I38158 SX I38157 DX	I38155 SX I38154 DX
PREZZO PRICE	€ 46,00 m ²	€ 58,00 m ²	€ 8,00 PZ/PCE	€ 9,00 PZ/PCE	€ 26,00 PZ/PCE	€ 28,00 PZ/PCE	€ 140,00 PZ/PCE	€ 148,00 PZ/PCE	€ 164,00 PZ/PCE	€ 176,00 PZ/PCE	€ 106,00 PZ/PCE	€ 112,00 PZ/PCE	€ 134,00 PZ/PCE	€ 134,00 PZ/PCE
CODICE PREZZO PRICE CODE	MI09	MI25	P029	P033	P069	P073	P207	P215	P231	P243	P173	P179	P201	P201
IMBALLO cm h. PACKING cm h.	EPAL 80x120		Pallet 80x120		Pallet 80x120		Pallet 80x120		Pallet 80x120		Pallet 80x120		Pallet 80x120	
Tara / Tare	20		-		-		-		-		-		-	
 x 	2		6		1		2		1		2		1	
m ² x 	1,44		-		-		-		-		-		-	
Kg x 	33,41		11,4		12		22		11		22		11	
 x 	30		-		-		-		-		-		-	
m ² x 	43,2		-		-		-		-		-		-	
Kg x 	1.025		-		-		-		-		-		-	

**

PEZZI SPECIALI - A disposizione solo su richiesta. Tempi di consegna: 30gg.

TRIMS - Available upon request only. Delivery terms: 30 days.

PIÈCES SPECIALES - Disponible seulement sur requête. Délais de livraison: 30 jours.

FORMSTÜCKE - Verfügbar auf Anfrage. Lieferzeit: 30 Tage.

PIEZAS ESPECIALES - Disponible sólo bajo pedido. Plazo de entrega: 30 días.

СПЕЦИАЛНЫЕ ЭЛЕМЕНТЫ - Изготавливается только по специальной заявке. Срок поставки: 30 дней.

WHITE MACAUBA

LASTRE IN GRES PORCELLANATO PRESSATE A SECCO . DRY-PRESSED PORCELAIN STONEWARE SLABS .
 DALLES EN GRÈS CÉRAME PRESSÉES À SEC . TROCKENGEPRESSTE PLATTEN AUS FEINSTEINZEUG .
 PLANCHAS EN GRÈS PORCELÁNICO PRENSADAS EN SECO . КЕРАМОГРАНИТНЫЕ ПЛИТЫ СУХОГО ПРЕССОВАНИЯ .
 UNI EN 14411-ISO 13006 - Appendice C - Gruppo BIa - UGL

100% DESIGN
 AND PRODUCTION
 OF ITALY

V2
 SHADE SPECTRUM
 MODERATE

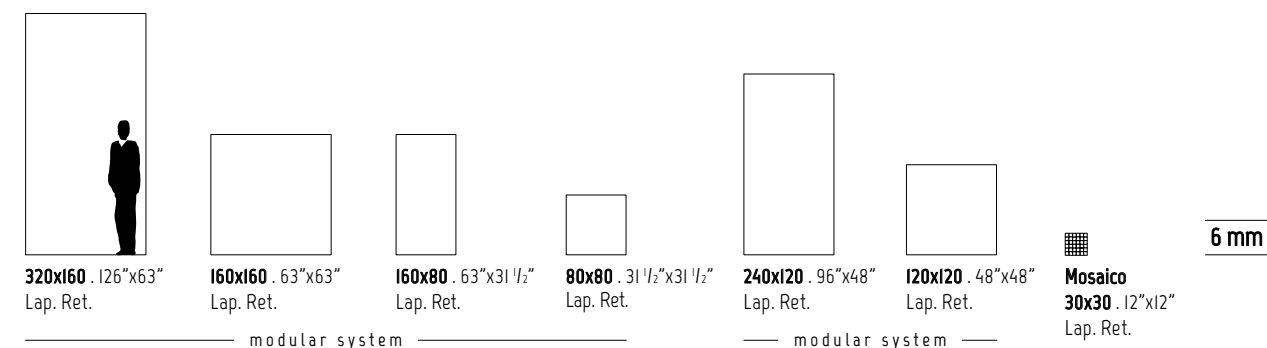

INDOOR

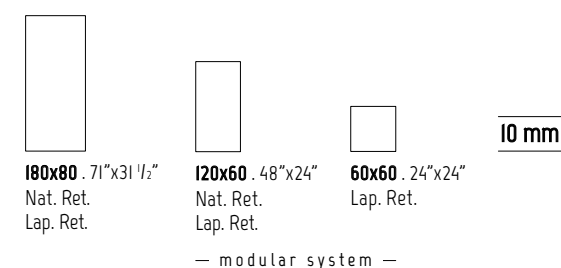

SVILUPPO GRAFICO PER FORMATO Pattern by size Développement graphique par format Grafischer Entwurf für Format Desarrollo gráfico por formato Варианты графики для каждого формата	320x160 6 mm	160x160 6 mm	160x80 6 mm	80x80 6 mm	240x120 6 mm	120x120 6 mm	180x80 10 mm	120x60 10 mm	60x60 10 mm
	7	14	28	56	11	22	14	18	36

WHITE MACAUBA

Wall
White Macauba 180x80 (71"x31 1/2") Lap. Ret.

Floor
White Macauba 180x80 (71"x31 1/2") Lap. Ret.





320x160
SVILUPPO GRAFICO PER FORMATO - 7 Pattern by size
 7 Développement graphique par format - 7 Grafischer Entwurf für Format
 7 Desarrollo gráfico por formato - 7 Варианты графики для каждого формата

6 mm



087017
320x160 . 126"x63"
 Lap. Ret.

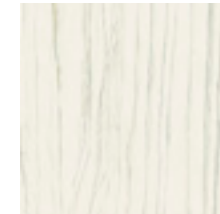

087052
160x160 . 63"x63"
 Lap. Ret.



087092
160x80 . 63"x31 1/2"
 Lap. Ret.



087112
80x80 . 31 1/2"x31 1/2"
 Lap. Ret.



087036
240x120 . 96"x48"
 Lap. Ret.



087072
120x120 . 48"x48"
 Lap. Ret.



Mosaico
087168
30x30 . 12"x12"
 Lap. Ret.

— modular system —

— modular system —

INDOOR

10 mm

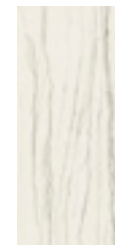

087614
180x80 . 71"x31 1/2"
 Nat. Ret.



087133
120x60 . 48"x24"
 Nat. Ret.



087151
60x60 . 24"x24"
 Lap. Ret.

087613
180x80 . 71"x31 1/2"
 Lap. Ret.

087131
120x60 . 48"x24"
 Lap. Ret.

— modular system —

WHITE MACAUBA

6 mm

	modular system					modular system					Mosaico Mosaic	Battiscopa Skirting	Scuretto Rabbeted riser	Gradino costa retta Straight nosed stair **	Gradino costa retta - Angolo SX / DX Straight-edge step - LH/RH corner **	Gradino Bordo Dritto Straight-edge step **	Gradino Bordo Dritto - Angolo SX / DX Straight-edge step - LH/RH corner **					
	320x160 126"x63" Lap. Ret.	160x160 63"x63" Lap. Ret.	160x80 63"x31 1/2" Lap. Ret.	80x80 31 1/2"x31 1/2" Lap. Ret.	240x120 96"x48" Lap. Ret.	120x120 48"x48" Lap. Ret.	30x30 12"x12" Lap. Ret.	8x80 3"x31 1/2" Lap. Ret.	20x160 8"x63" Lap. Ret.	20x80 8"x31 1/2" Lap. Ret.	33x160x3,2h 13"x63"x1 1/4" Lap. Ret.	33x120x3,2h 13"x48"x1 1/4" Lap. Ret.	33x80x3,2h 13"x31 1/2"x1 1/4" Lap. Ret.	33x160x3,2h 13"x63"x1 1/4" Lap. Ret.	33x120x3,2h 13"x48"x1 1/4" Lap. Ret.	33x80x3,2h 13"x31 1/2"x1 1/4" Lap. Ret.	30x160x4h 12"x63"x1 1/2" Lap. Ret.	30x120x4h 12"x48"x1 1/2" Lap. Ret.	30x80x4h 12"x31 1/2"x1 1/2" Lap. Ret.	30x160x4h 12"x63"x1 1/2" Lap. Ret.	30x120x4h 12"x48"x1 1/2" Lap. Ret.	30x80x4h 12"x31 1/2"x1 1/2" Lap. Ret.
WHITE MACAUBA	087017	087052	087092	087112	087036	087072	087168	087225	087280	087299	087330	087657	087386	087332 SX 087331 DX	087659 SX 087658 DX	087388 SX 087387 DX	087436	087479	087512	087438 SX 087437 DX	087481 SX 087480 DX	087514 SX 087513 DX
PREZZO PRICE	€ 130,00 m ²	€ 120,00 m ²	€ 102,00 m ²	€ 72,00 m ²	€ 108,00 m ²	€ 102,00 m ²	€ 168,00 m ²	€ 8,00 PZ/PCE	€ 42,00 PZ/PCE	€ 30,00 PZ/PCE	€ 312,00 PZ/PCE	€ 198,00 PZ/PCE	€ 108,00 PZ/PCE	€ 344,00 PZ/PCE	€ 232,00 PZ/PCE	€ 148,00 PZ/PCE	€ 200,00 PZ/PCE	€ 134,00 PZ/PCE	€ 76,00 PZ/PCE	€ 276,00 PZ/PCE	€ 190,00 PZ/PCE	€ 130,00 PZ/PCE
CODICE PREZZO PRICE CODE	M197	M187	M169	M139	M175	M169	M235	P029	P101	P077	P323	P265	P175	P339	P283	P215	P267	P201	P143	P305	P257	P197
IMBALLO cm h. PACKING cm h.	345x175	330x75	182,6x173,6	330x75	168x97	EPAL 80x120	264x136,6	250x75	143x123	250x75	EPAL 80x120	Pallet 80x120	Pallet 168x97	Pallet 80x120	Pallet 168x97	Pallet 80x120	Pallet 168x97	Pallet 80x120	Pallet 168x97	Pallet 80x120	Pallet 168x97	Pallet 80x120
Tara / Tare	140,00	210,00	71,80	210,00	-	20	100,00	158,00	-	158,00	-	-	-	-	-	-	-	-	-	-	-	-
N°	14	44	24	88	-	-	20	44	-	88	-	-	-	-	-	-	-	-	-	-	-	-
m ² x	5,12	5,12	2,56	2,56	-	-	2,88	2,88	-	1,44	-	-	-	-	-	-	-	-	-	-	-	-
Kg x	74,14	74,14	37,07	37,07	-	-	41,70	41,70	-	20,85	-	-	-	-	-	-	-	-	-	-	-	-
m ² x	-	-	-	-	2	3	-	-	2	-	-	12	-	-	-	-	-	-	-	-	-	-
Kg x	-	-	-	-	37,2	27,90	-	-	41,70	-	-	11,50	-	-	-	-	-	-	-	-	-	-
m ² x	71,68	225,28	61,44	225,28	38,40	76,80	57,60	126,72	69,12	126,72	-	-	-	-	-	-	-	-	-	-	-	-
Kg x	1.178	3.472	962	3.472	648	1.141	934	1.993	1.057	1.993	-	-	-	-	-	-	-	-	-	-	-	-



Cavalletto in legno
Wood A-Frame
Support en bois
Holzgestell
Caballete de madera
Деревянная подставка



Cassa
Crate
Caisse
Kiste
Caja
Ящик













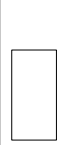



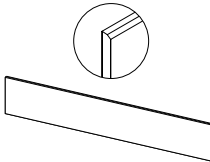
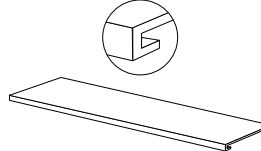
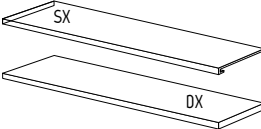
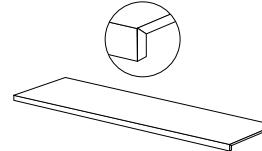
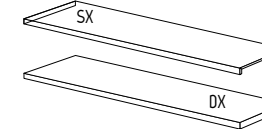

Pallet speciale con sponde
Special pallet with sides
Palette spéciale avec bords
Spezial-Palette mit Wandungen
Palet especial con bordes
Специальный поддон с боковинами

** PEZZI SPECIALI - A disposizione solo su richiesta. Tempi di consegna: 30gg.
TRIMS - Available upon request only. Delivery terms: 30 days.
PIÈCES SPECIALES - Disponible seulement sur requête. Délais de livraison: 30 jours.
FORMSTÜCKE - Verfügbar auf Anfrage. Lieferzeit: 30 Tage.
PIEZAS ESPECIALES - Disponible sólo bajo pedido. Plazo de entrega: 30 días.
СПЕЦИАЛЬНЫЕ ЭЛЕМЕНТЫ - Изготавливается только по специальной заявке. Срок поставки: 30 дней.

WHITE MACAUBA INDOOR

10 mm

	modular system					Battiscopa Skirting	Scuretto Rabbeted riser	Gradino costa retta Straight nosed stair **	Gradino costa retta - Angolo SX / DX Straight-edge step - LH/RH corner **	Gradino Bordo Dritto Straight-edge step **	Gradino Bordo Dritto - Angolo SX / DX Straight-edge step - LH/RH corner **
	 180x80 71"x31 1/2" Nat. Ret.	 180x80 71"x31 1/2" Lap. Ret.	 120x60 48"x24" Nat. Ret.	 120x60 48"x24" Lap. Ret.	 60x60 24"x24" Lap. Ret.	 6,5x120 2 1/2"x48" Lap. Ret.	 20x120 8"x48" Lap. Ret.	 33x120x3,2h 13"x48"x1 1/4" Lap. Ret.	 33x120x3,2h 13"x48"x1 1/4" Lap. Ret.	 30x120x4h 12"x48"x1 1/2" Lap. Ret.	 30x120x4h 12"x48"x1 1/2" Lap. Ret.
WHITE MACAUBA 	087614	087613	087133	087131	087151	087223	087289	087413	087415 SX 087414 DX	087648	087650 SX 087649 DX
PREZZO PRICE	€ 58,00 m ²	€ 76,00 m ²	€ 46,00 m ²	€ 58,00 m ²	€ 48,00 m ²	€ 9,00 PZ/PCE	€ 28,00 PZ/PCE	€ 14,8,00 PZ/PCE	€ 176,00 PZ/PCE	€ 112,00 PZ/PCE	€ 134,00 PZ/PCE
CODICE PREZZO PRICE CODE	M125	M143	M109	M125	M113	P033	P073	P215	P243	P179	P201
	97x188		EPAL 80x120		EPAL 80x120	Pallet 80x120	Pallet 80x120	Pallet 80x120	Pallet 80x120	Pallet 80x120	Pallet 80x120
IMBALLO cm h. PACKING cm h.	55		-		-	-	-	-	-	-	-
Tara / Tare	-		20		20	-	-	-	-	-	-
 x 	2		2		3	6	1	2	1	2	1
m ² x 	2,88		1,44		1,08	-	-	-	-	-	-
Kg x 	69,12		33,41		24,80	11,4	12	22	11	22	11
 x 	20		30		40	-	-	-	-	-	-
m ² x 	57,6		43,2		43,2	-	-	-	-	-	-
Kg x 	1.412		1.025		1.012	-	-	-	-	-	-



Pallet speciale con sponde
Special pallet with sides
Palette spéciale avec bords
Spezial-Palette mit Wandungen
Palet especial con bordes
Специальный поддон с боковинами

** PEZZI SPECIALI - A disposizione solo su richiesta. Tempi di consegna: 30gg.
TRIMS - Available upon request only. Delivery terms: 30 days.
PIÈCES SPECIALES - Disponible seulement sur requête. Délais de livraison: 30 jours.
FORMSTÜCKE - Verfügbar auf Anfrage. Lieferzeit: 30 Tage.
PIEZAS ESPECIALES - Disponible sólo bajo pedido. Plazo de entrega: 30 días.
СПЕЦИАЛЬНЫЕ ЭЛЕМЕНТЫ - Изготавливается только по специальной заявке. Срок поставки: 30 дней.



MATERICO

Textured . Matièreque . Materisch . Matérico . Фактурная поверхность .

INDOOR

ABSOLUTE.....	300
CITY.....	314
DISTRICT.....	322
METAL.....	338
SKYLINE.....	356

OUTDOOR RII-C

SKYLINE.....	376
--------------	-----

OUTDOOR 20 mm . RII-C

SKYLINE.....	378
--------------	-----

ABSOLUTE

BLACK

WHITE

LASTRE IN GRES PORCELLANATO PRESSATE A SECCO . DRY-PRESSED PORCELAIN STONWARE SLABS .
 DALLES EN GRÈS CÉRAMÉ PRESSÉES À SEC . TROCKENGEPRESSTE PLATTEN AUS FEINSTEINZEUG .
 PLANCHAS EN GRÈS PORCELÁNICO PRENSADAS EN SECO . КЕРАМОГРАНИТНЫЕ ПЛИТЫ СУХОГО ПРЕССОВАНИЯ .
 UNI EN 14411-ISO 13006 - Appendice C - Gruppo BIa - UGL

100% DESIGN
AND PRODUCTION
OF ITALY

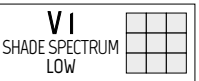

12 mm

324x163 . 127"x64"
 Nat.
 Lap. Nat.

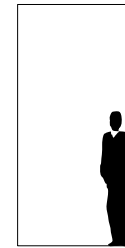

320x160 . 126"x63"
 Nat. Ret.
 Lap. Ret.



160x160 . 63"x63"
 Nat. Ret.
 Lap. Ret.



160x80 . 63"x31 1/2"
 Nat. Ret.
 Lap. Ret.



80x80 . 31 1/2"x31 1/2"
 Nat. Ret.
 Lap. Ret.



240x120 . 96"x48"
 Nat. Ret.
 Lap. Ret.

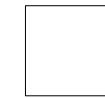

120x120 . 48"x48"
 Nat. Ret.
 Lap. Ret.



Mosaico 30x30 . 12"x12"
 Nat. Ret.
 Lap. Ret.

6 mm

— modular system —

— modular system —

INDOOR



120x60 . 48"x24"
 Nat. Ret.



60x60 . 24"x24"
 Nat. Ret.

10 mm

— modular system —

SVILUPPO GRAFICO PER FORMATO
 Pattern by size
 Développement graphique par format
 Grafischer Entwurf für Format
 Desarrollo gráfico por formato
 Варианты графики для каждого формата

320x160	160x160	160x80	80x80	240x120	120x120	120x60	60x60	324x163
6 mm	6 mm	6 mm	6 mm	6 mm	6 mm	10 mm	10 mm	12 mm





< Wall
White 320x160 (126"x63") Nat. Ret.
Top e arredi / Counter top and furniture
White Lap. Ret.
Floor
White 120x120 (48"x48") Lap. Ret.

Rivestimento e arredi / Wall and furniture
Black Nat. Ret. / Lap. Ret.
Floor
White 120x120 (48"x48") Nat. Ret.

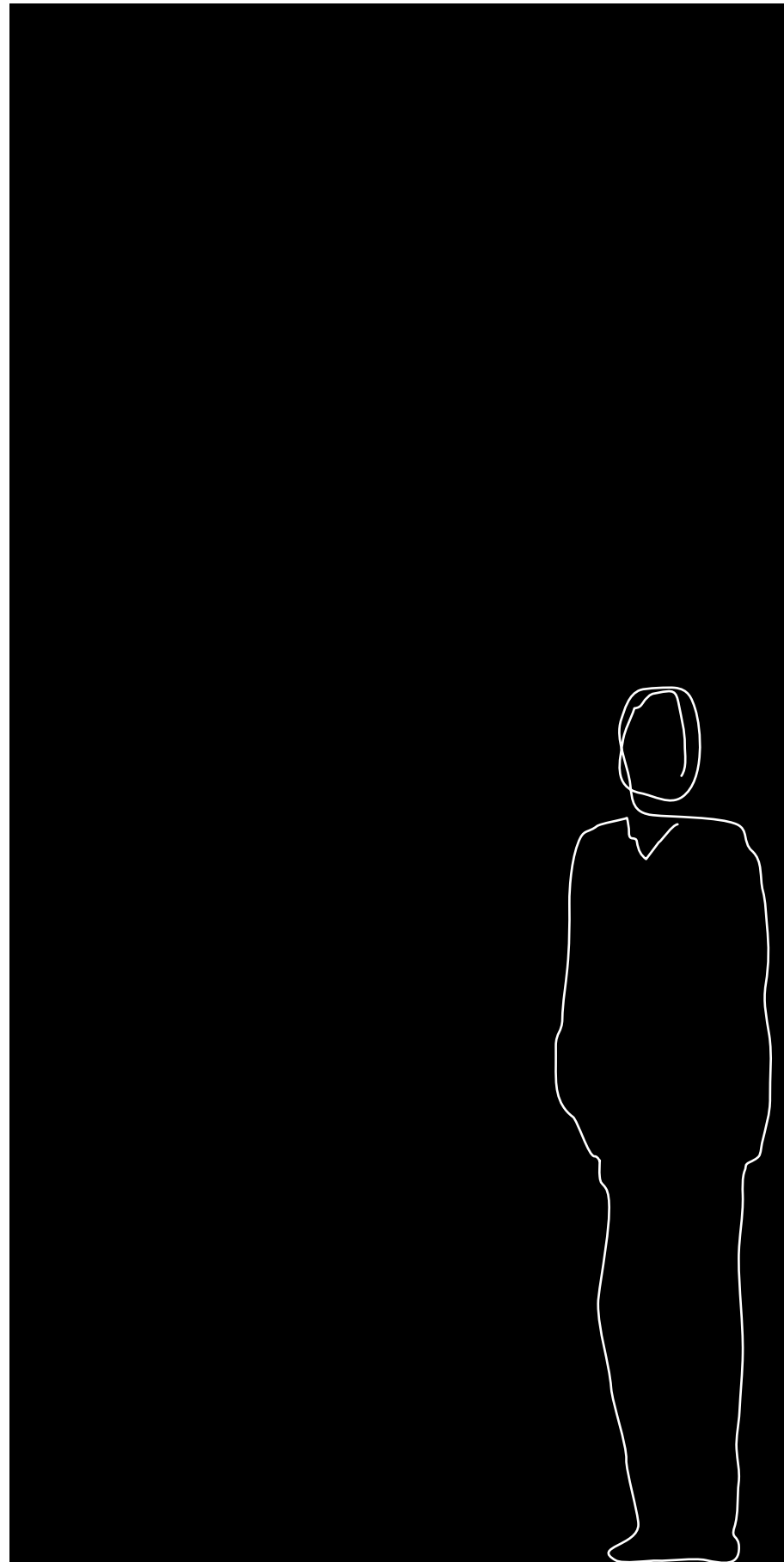

12 mm



097903
324x163 . 127"x64"
Nat.

097904
324x163 . 127"x64"
Lap. Nat.

6 mm

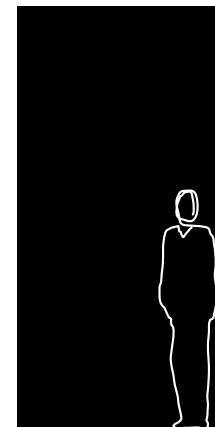

097005
320x160 . 126"x63"
Nat. Ret.

097004
320x160 . 126"x63"
Lap. Ret.



097035
160x160 . 63"x63"
Nat. Ret.

097034
160x160 . 63"x63"
Lap. Ret.



097056
160x80 . 63"x31 1/2"
Nat. Ret.

097055
160x80 . 63"x31 1/2"
Lap. Ret.



097066
80x80 . 31 1/2"x31 1/2"
Nat. Ret.

097065
80x80 . 31 1/2"x31 1/2"
Lap. Ret.



097025
240x120 . 96"x48"
Nat. Ret.

097024
240x120 . 96"x48"
Lap. Ret.



097045
120x120 . 48"x48"
Nat. Ret.

097044
120x120 . 48"x48"
Lap. Ret.



Mosaico
097123
30x30 . 12"x12"
Nat. Ret.

097122
30x30 . 12"x12"
Lap. Ret.

modular system

modular system

INDOOR

10 mm



097085
120x60 . 48"x24"
Nat. Ret.



097095
60x60 . 24"x24"
Nat. Ret.

modular system

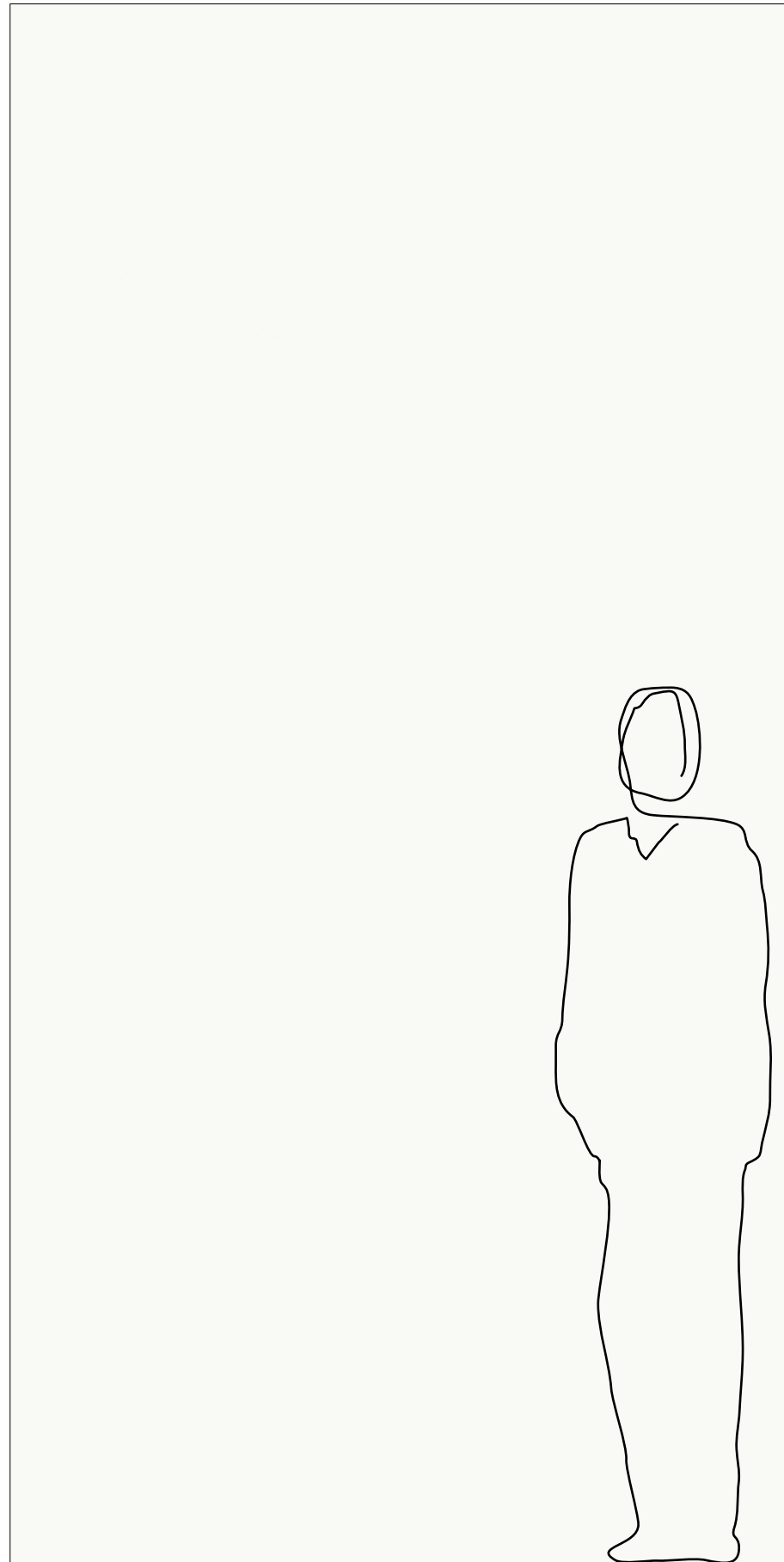

12 mm

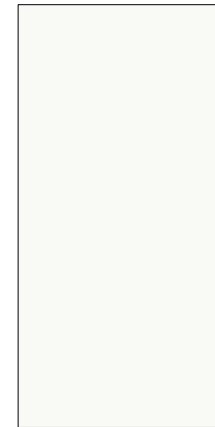

097901
324x163 . 127"x64"
Nat.
097902
324x163 . 127"x64"
Lap. Nat.

6 mm

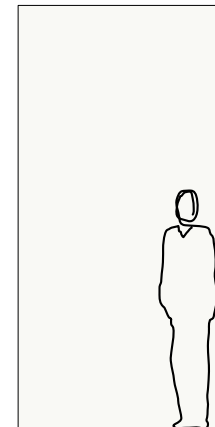

097002
320x160 . 126"x63"
Nat. Ret.
097001
320x160 . 126"x63"
Lap. Ret.

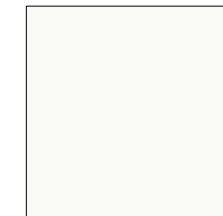

097032
160x160 . 63"x63"
Nat. Ret.
097031
160x160 . 63"x63"
Lap. Ret.

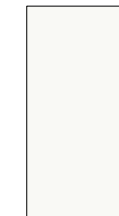

097052
160x80 . 63"x31 1/2"
Nat. Ret.
097051
160x80 . 63"x31 1/2"
Lap. Ret.



097062
80x80 . 31 1/2"x31 1/2"
Nat. Ret.
097061
80x80 . 31 1/2"x31 1/2"
Lap. Ret.



097022
240x120 . 96"x48"
Nat. Ret.
097021
240x120 . 96"x48"
Lap. Ret.

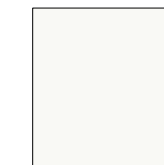

097042
120x120 . 48"x48"
Nat. Ret.
097041
120x120 . 48"x48"
Lap. Ret.



Mosaico
097121
30x30 . 12"x12"
Nat. Ret.
097120
30x30 . 12"x12"
Lap. Ret.

modular system

modular system

INDOOR

10 mm



097081
120x60 . 48"x24"
Nat. Ret.



097091
60x60 . 24"x24"
Nat. Ret.











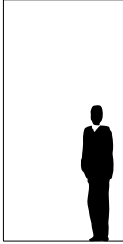

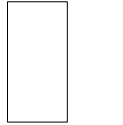
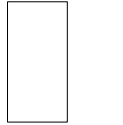



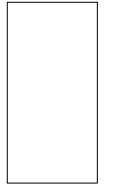







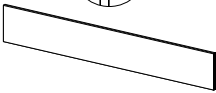
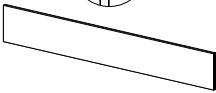
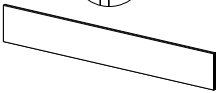
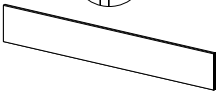







modular system

ABSOLUTE

6 mm

SOLO SUPERFICIE NATURALE
ONLY NATURAL SURFACE

ANSI A - 137.1: 2012
WET DYNAMIC COEFFICIENT OF FRICTION | DCOF ≥ 0,42

	modular system								modular system				Mosaico Mosaic	Battiscopa Skirting	Scuretto Rabbeted riser					
																				
	320x160 126"x63" Nat. Ret.	320x160 126"x63" Lap. Ret.	160x160 63"x63" Nat. Ret.	160x160 63"x63" Lap. Ret.	160x80 63"x31 1/2" Nat. Ret.	160x80 63"x31 1/2" Lap. Ret.	80x80 31 1/2"x31 1/2" Nat. Ret.	80x80 31 1/2"x31 1/2" Lap. Ret.	240x120 96"x48" Nat. Ret.	240x120 96"x48" Lap. Ret.	120x120 48"x48" Nat. Ret.	120x120 48"x48" Lap. Ret.	30x30 12"x12" Nat. Ret.	30x30 12"x12" Lap. Ret.	8x80 3"x31 1/2" Nat. Ret.	8x80 3"x31 1/2" Lap. Ret.	20x160 8"x63" Nat. Ret.	20x160 8"x63" Lap. Ret.	20x80 8"x31 1/2" Nat. Ret.	20x80 8"x31 1/2" Lap. Ret.
BLACK	097005	097004	097035	097034	097056	097055	097066	097065	097025	097024	097045	097044	097123	097122	097119	097118	097135	097133	097141	097139
WHITE	097002	097001	097032	097031	097052	097051	097062	097061	097022	097021	097042	097041	097121	097120	097116	097115	097134	097132	097140	097138
PREZZO PRICE	€ 114,00 m ²	€ 138,00 m ²	€ 102,00 m ²	€ 126,00 m ²	€ 88,00 m ²	€ 112,00 m ²	€ 66,00 m ²	€ 81,00 m ²	€ 96,00 m ²	€ 118,00 m ²	€ 84,00 m ²	€ 110,00 m ²	€ 126,00 m ²	€ 168,00 m ²	€ 7,00 PZ/PCE	€ 8,00 PZ/PCE	€ 30,00 PZ/PCE	€ 42,00 PZ/PCE	€ 22,00 PZ/PCE	€ 30,00 PZ/PCE
CODICE PREZZO PRICE CODE	M181	M205	M169	M193	M155	M179	M133	M148	M163	M185	M151	M177	M193	M235	P025	P029	P077	P101	P061	P077
IMBALLO cm h. PACKING cm h.	 345x175	 330x75	 182,6x173,6	 330x75	 168x97	EPAL 80x120		 264x136,6	 250x75	 143x123	 250x75	EPAL 80x120		Pallet 80x120		 168x97	Pallet 80x120			
Tara / Tare	140,00	210,00	71,80	210,00	-	20		100,00	158,00	-	158,00	-	-	-	-	-	-	-	-	-
N°	14	44	24	88	-	-		20	44	-	88	-	-	-	-	-	-	-	-	-
m ² x	5,12	5,12	2,56	2,56	-	-		2,88	2,88	-	1,44	-	-	-	-	-	-	-	-	-
Kg x	74,14	74,14	37,07	37,07	-	-		41,70	41,70	-	20,85	-	-	-	-	-	-	-	-	-
 x 	-	-	-	-	2	3		-	-	2	-	-	-	-	12	1	1	-	-	1
m ² x 	-	-	-	-	2,56	1,92		-	-	2,88	-	-	-	-	0,77	-	-	-	-	-
Kg x 	-	-	-	-	37,2	27,90		-	-	41,70	-	-	-	-	11,50	5	3	-	-	3
 x 	-	-	-	-	15	40		-	-	24	-	-	-	-	-	-	-	-	-	-
m ² x 	71,68	225,28	61,44	225,28	38,40	76,80		57,60	126,72	69,12	126,72	-	-	-	-	-	-	-	-	-
Kg x 	1.178	3.472	962	3.472	648	1.141		934	1.993	1.057	1.993	-	-	-	-	-	-	-	-	-



Cavalletto in legno
Wood A-Frame
Support en bois
Holzgestell
Caballete de madera
Деревянная подставка



Cassa
Crate
Caisse
Kiste
Caja
Ящик

















Pallet speciale con sponde
Special pallet with sides
Palette spéciale avec bords
Spezial-Palette mit Wandungen
Palet especial con bordes
Специальный поддон с боковинами

ABSOLUTE

6 mm

SOLO SUPERFICIE NATURALE ONLY NATURAL SURFACE ANSI A - 137.1: 2012 WET DYNAMIC COEFFICIENT OF FRICTION **DCOF ≥ 0,42**

	Gradino costa retta Straight nosed stair **						Gradino costa retta - Angolo SX / DX Straight-edge step - LH/RH corner **						Gradino Bordo Dritto Straight-edge step **						Gradino Bordo Dritto - Angolo SX / DX Straight-edge step - LH/RH corner **																	
	33x160x3,2h 13"x63"x1 1/4"h Nat. Ret.		33x160x3,2h 13"x63"x1 1/4"h Lap. Ret.		33x120x3,2h 13"x48"x1 1/4"h Nat. Ret.		33x120x3,2h 13"x48"x1 1/4"h Lap. Ret.		33x80x3,2h 13"x31 1/2"x1 1/4"h Nat. Ret.		33x80x3,2h 13"x31 1/2"x1 1/4"h Lap. Ret.		30x160x4h 12"x63"x1 1/2"h Nat. Ret.		30x160x4h 12"x63"x1 1/2"h Lap. Ret.		30x120x4h 12"x48"x1 1/2"h Nat. Ret.		30x120x4h 12"x48"x1 1/2"h Lap. Ret.		30x80x4h 12"x31 1/2"x1 1/2"h Nat. Ret.		30x80x4h 12"x31 1/2"x1 1/2"h Lap. Ret.		30x160x4h 12"x63"x1 1/2"h Nat. Ret.		30x160x4h 12"x63"x1 1/2"h Lap. Ret.		30x120x4h 12"x48"x1 1/2"h Nat. Ret.		30x120x4h 12"x48"x1 1/2"h Lap. Ret.		30x80x4h 12"x31 1/2"x1 1/2"h Nat. Ret.		30x80x4h 12"x31 1/2"x1 1/2"h Lap. Ret.	
BLACK 	097224	097222	097228	097226	097276	097275	097218 SX 097220 DX	097214 SX 097216 DX	097266 SX 097264 DX	097250 SX 097230 DX	097282 SX 097280 DX	097284 SX 097278 DX	097204	097202	097233	097234	097254	097253	097213 SX 097208 DX	097212 SX 097207 DX	097242 SX 097238 DX	097241 SX 097237 DX	097262 SX 097258 DX	097261 SX 097257 DX	097203	097201	097232	097231	097252	097251	097211 SX 097206 DX	097209 SX 097205 DX	097240 SX 097236 DX	097239 SX 097235 DX	097260 SX 097256 DX	097259 SX 097255 DX
WHITE 	097223	097221	097227	097225	097274	097273	097217 SX 097219 DX	097210 SX 097215 DX	097265 SX 097263 DX	097249 SX 097229 DX	097281 SX 097279 DX	097283 SX 097277 DX	097203	097201	097232	097231	097252	097251	097211 SX 097206 DX	097209 SX 097205 DX	097240 SX 097236 DX	097239 SX 097235 DX	097260 SX 097256 DX	097259 SX 097255 DX	097203	097201	097232	097231	097252	097251	097211 SX 097206 DX	097209 SX 097205 DX	097240 SX 097236 DX	097239 SX 097235 DX	097260 SX 097256 DX	097259 SX 097255 DX
PREZZO PRICE	€ 272,00 PZIPCE	€ 312,00 PZIPCE	€ 176,00 PZIPCE	€ 198,00 PZIPCE	€ 100,00 PZIPCE	€ 108,00 PZIPCE	€ 304,00 PZIPCE	€ 344,00 PZIPCE	€ 212,00 PZIPCE	€ 232,00 PZIPCE	€ 136,00 PZIPCE	€ 148,00 PZIPCE	€ 178,00 PZIPCE	€ 200,00 PZIPCE	€ 132,00 PZIPCE	€ 140,00 PZIPCE	€ 68,00 PZIPCE	€ 76,00 PZIPCE	€ 240,00 PZIPCE	€ 276,00 PZIPCE	€ 186,00 PZIPCE	€ 198,00 PZIPCE	€ 116,00 PZIPCE	€ 130,00 PZIPCE	€ 178,00 PZIPCE	€ 200,00 PZIPCE	€ 132,00 PZIPCE	€ 140,00 PZIPCE	€ 68,00 PZIPCE	€ 76,00 PZIPCE	€ 240,00 PZIPCE	€ 276,00 PZIPCE	€ 186,00 PZIPCE	€ 198,00 PZIPCE	€ 116,00 PZIPCE	€ 130,00 PZIPCE
CODICE PREZZO PRICE CODE	P303	P323	P243	P265	P167	P175	P319	P339	P273	P283	P203	P215	P245	P267	P199	P207	P135	P143	P287	P305	P253	P265	P183	P197	P245	P267	P199	P207	P135	P143	P287	P305	P253	P265	P183	P197
IMBALLO cm h. PACKING cm h.	 168x97	Pallet 80x120		Pallet 80x120		 168x97	Pallet 80x120		Pallet 80x120		 168x97	Pallet 80x120		Pallet 80x120		 168x97	Pallet 80x120		Pallet 80x120		Pallet 80x120		 168x97	Pallet 80x120		Pallet 80x120		Pallet 80x120		Pallet 80x120						
Tara / Tare	-	-	-	-	-	-	-	-	-	-	-	-	-	-	-	-	-	-	-	-	-	-	-	-	-	-	-	-	-	-	-	-	-	-		
 x 	1	2	2	1	1	1	1	1	1	1	1	1	1	2	2	1	1	1	1	1	1	1	1	1	1	2	2	1	1	1	1	1	1	1		
m ² x 	-	-	-	-	-	-	-	-	-	-	-	-	-	-	-	-	-	-	-	-	-	-	-	-	-	-	-	-	-	-	-	-	-	-		
Kg x 	9	14	10	10	7	6	10	7	6	6	6	6	8,5	13,5	9	9	9	9	9,5	7	7	5	5	5	8,5	13,5	9	9	9	9	9	9	9	9		
 x 	-	-	-	-	-	-	-	-	-	-	-	-	-	-	-	-	-	-	-	-	-	-	-	-	-	-	-	-	-	-	-	-	-	-		
m ² x 	-	-	-	-	-	-	-	-	-	-	-	-	-	-	-	-	-	-	-	-	-	-	-	-	-	-	-	-	-	-	-	-	-	-		
Kg x 	-	-	-	-	-	-	-	-	-	-	-	-	-	-	-	-	-	-	-	-	-	-	-	-	-	-	-	-	-	-	-	-	-	-		















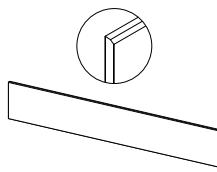
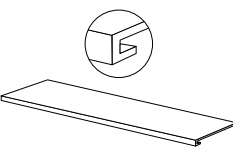
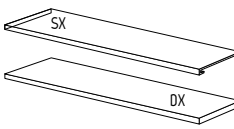
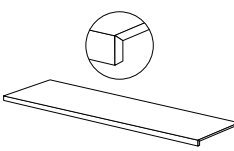
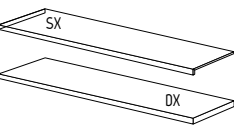

Pallet speciale con sponde
Special pallet with sides
Palette spéciale avec bords
Spezial-Palette mit Wandungen
Palet especial con bordes
Специальный поддон с боковинами

** PEZZI SPECIALI - A disposizione solo su richiesta. Tempi di consegna: 30gg.
TRIMS - Available upon request only. Delivery terms: 30 days.
PIÈCES SPECIALES - Disponible seulement sur requête. Délais de livraison: 30 jours.
FORMSTÜCKE - Verfügbar auf Anfrage. Lieferzeit: 30 Tage.
PIEZAS ESPECIALES - Disponible sólo bajo pedido. Plazo de entrega: 30 días.
СПЕЦИАЛЬНЫЕ ЭЛЕМЕНТЫ - Изготавливается только по специальной заявке. Срок поставки: 30 дней.

ABSOLUTE INDOOR

10 mm

modular system

	 120x60 48"x24" Nat. Ret.	 60x60 24"x24" Nat. Ret.	 6,5x120 2 1/2"x48" Nat. Ret.	 20x120 8"x48" Nat. Ret.	 33x120x3,2h 13"x48"x1 1/4" Nat. Ret.	 33x120x3,2h 13"x48"x1 1/4" Nat. Ret.	 30x120x4h 12"x48"x1 1/2" Nat. Ret.	 30x120x4h 12"x48"x1 1/2" Nat. Ret.
BLACK 	097085	097095	097111	097137	097268	097272 SX 097270 DX	097244	097248 SX 097246 DX
WHITE 	097081	097091	097110	097136	097267	097271 SX 097269 DX	097243	097247 SX 097245 DX
PREZZO PRICE	€ 54,00 m ²	€ 46,00 m ²	€ 8,00 PZ/PCE	€ 26,00 PZ/PCE	€ 140,00 PZ/PCE	€ 164,00 PZ/PCE	€ 106,00 PZ/PCE	€ 134,00 PZ/PCE
CODICE PREZZO PRICE CODE	M121	M109	P029	P069	P207	P231	P173	P201
	EPAL 80x120	EPAL 80x120	Pallet 80x120	Pallet 80x120	Pallet 80x120	Pallet 80x120	Pallet 80x120	Pallet 80x120
IMBALLO cm h. PACKING cm h. 	-	-	-	-	-	-	-	-
Tara / Tare	20	20	-	-	-	-	-	-
 x 	2	3	6	1	2	1	2	1
m ² x 	1,44	1,08	-	-	-	-	-	-
Kg x 	33,41	24,80	11,4	12	22	11	22	11
 x 	30	40	-	-	-	-	-	-
m ² x 	43,2	43,2	-	-	-	-	-	-
Kg x 	1.025	1.012	-	-	-	-	-	-

**

PEZZI SPECIALI - A disposizione solo su richiesta. Tempi di consegna: 30gg.

TRIMS - Available upon request only. Delivery terms: 30 days.

PIÈCES SPECIALES - Disponible seulement sur requête. Délais de livraison: 30 jours.

FORMSTÜCKE - Verfügbar auf Anfrage. Lieferzeit: 30 Tage.

PIEZAS ESPECIALES - Disponible sólo bajo pedido. Plazo de entrega: 30 días.













СПЕЦИАЛНЫЕ ЭЛЕМЕНТЫ - Изготавливается только по специальной заявке. Срок поставки: 30 дней.

SOLO SUPERFICIE NATURALE
ONLY NATURAL SURFACE

ANSI A - 137.1: 2012
WET DYNAMIC COEFFICIENT OF FRICTION

DCOF ≥ 0,42

12 mm

	 324x163 127"x64" Nat.	 324x163 127"x64" Lap. Nat.	
BLACK 	097903	097904	
WHITE 	097901	097902	
PREZZO PRICE	€ 160,00 m ²	€ 212,00 m ²	
CODICE PREZZO PRICE CODE	M227	M273	
	 345x175	 330x75	 330x75
IMBALLO cm h. PACKING cm h. 	37	193,5	193,5
Tara / Tare	150,00	229,00	259,00
N° 	7	22	22
m ² x 	5,28	116,16	116,16
Kg x 	152,47	152,47	152,47
m ² x 	36,96	116,16	116,16
Kg x 	1.217	3.583	3.613



Cassa
Crate
Caisse
Kiste
Caja
Ящик



Cavalletto in legno
Wood A-Frame
Support en bois
Holzgestell
Caballette de madera
Деревянная подставка



Cavalletto in ferro
Iron A-Frame
Support en fer
Metallgestell
Caballette de hierro
Металлическая подставка

CITY

OSLO

LONDON

MADRID

LASTRE IN GRES PORCELLANATO PRESSATE A SECCO . DRY-PRESSED PORCELAIN STONWARE SLABS .
DALLES EN GRÈS CÉRAMÉ PRESSÉES À SEC . TROCKENGEPRESSTE PLATTEN AUS FEINSTEINZEUG .
PLANCHAS EN GRES PORCELÁNICO PRENSADAS EN SECO . КЕРАМОГРАНИТНЫЕ ПЛИТЫ СУХОГО ПРЕССОВАНИЯ .
UNI EN 14411-ISO 13006 - Appendice C - Gruppo BIa - UGL

100% DESIGN
AND PRODUCTION
OF ITALY



V2
SHADE SPECTRUM
MODERATE

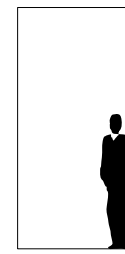

324x163 . 127"x64"
Nat.

12 mm

SVILUPPO GRAFICO PER FORMATO
Pattern by size
Développement graphique par format
Grafischer Entwurf für Format
Desarrollo gráfico por formato
Варианты графики для каждого формата

324x163
12 mm



Soffitto / Ceiling
Collection Metal: Greige 320x160 (126"x63") Nat. Ret.

Top e tavolo / Counter top and table
London 324x163 (127"x64") Nat. Ret.

Floor
Collection District: Nero 320x160 (126"x63") Nat. Ret.



OSLO



12 mm



I30903
324x163 . 127"x64"
Nat.

LONDON

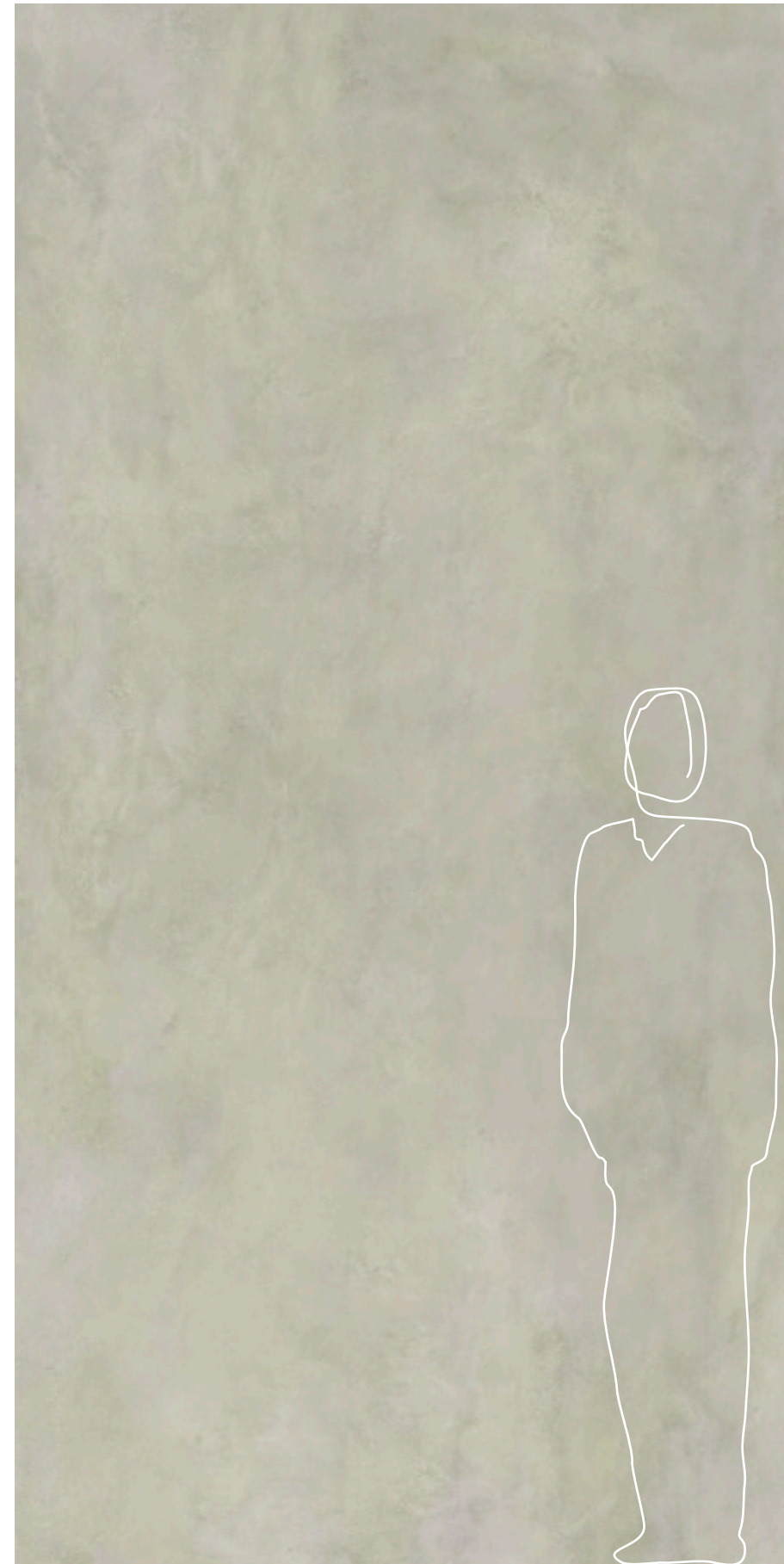

12 mm

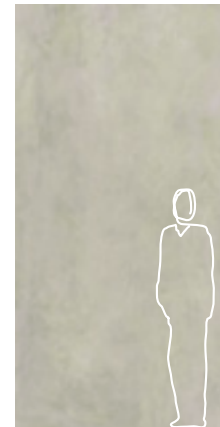

I30902
324x163 . 127"x64"
Nat.

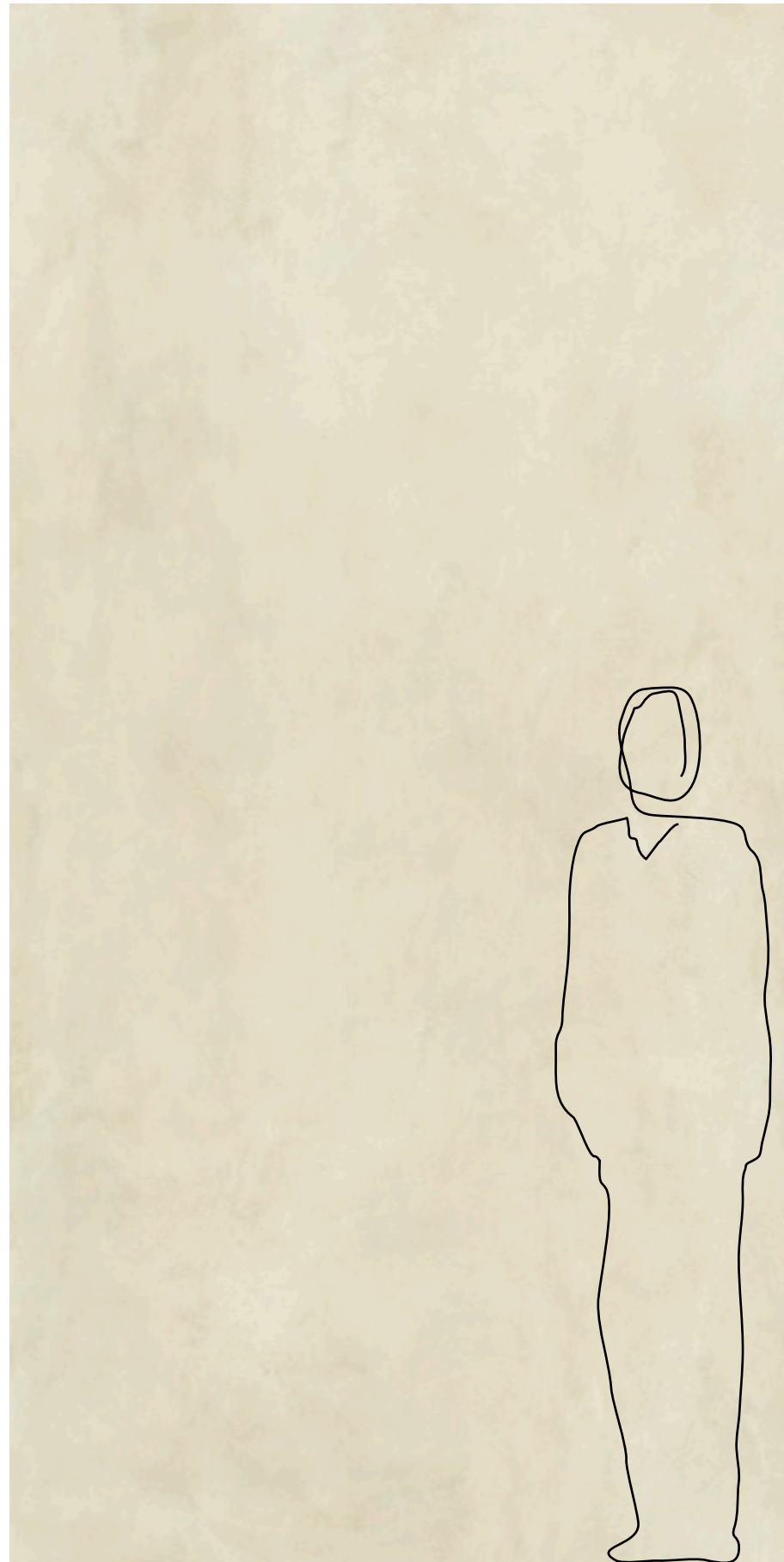

12 mm



I30901
324x163 . 127"x64"
Nat.

12 mm

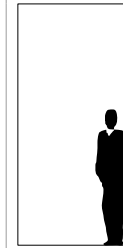

324x163
127"x64"
Nat.

ANSI A - 137.1: 2012
WET DYNAMIC COEFFICIENT OF FRICTION | DCOF ≥ 0,42

OSLO		I30903	
LONDON		I30902	
MADRID		I30901	
PREZZO PRICE	€ 154,00 m ²		
CODICE PREZZO PRICE CODE	M221		
	345x175	330x75	330x75
IMBALLO cm h. PACKING cm h.	37	193,5	193,5
Tara / Tare	150,00	229,00	259,00
N°	7	22	22
m ² x	5,28	116,16	116,16
Kg x	152,47	152,47	152,47
m ² x	36,96	116,16	116,16
Kg x	1.217	3.583	3.613



Cassa
Crate
Caisse
Kiste
Caja
Ящик



Cavalletto in legno
Wood A-Frame
Support en bois
Holzgestell
Caballote de madera
Деревянная подставка



Cavalletto in ferro
Iron A-Frame
Support en fer
Metallgestell
Caballote de hierro
Металлическая подставка



DISTRICT

NERO

GRIGIO

BIANCO

TORTORA

LASTRE IN GRES PORCELLANATO PRESSATE A SECCO . DRY-PRESSED PORCELAIN STONWARE SLABS .
 DALLES EN GRÈS CÉRAMÉ PRESSÉES À SEC . TROCKENGEPRESSTE PLATTEN AUS FEINSTEINZEUG .
 PLANCHAS EN GRES PORCELÁNICO PRENSADAS EN SECO . КЕРАМОГРАНИТНЫЕ ПЛИТЫ СУХОГО ПРЕССОВАНИЯ .
 UNI EN 14411-ISO 13006 - Appendice C - Gruppo BIa - UGL

100% DESIGN
AND PRODUCTION
OF ITALY

V2
SHADE SPECTRUM
MODERATE

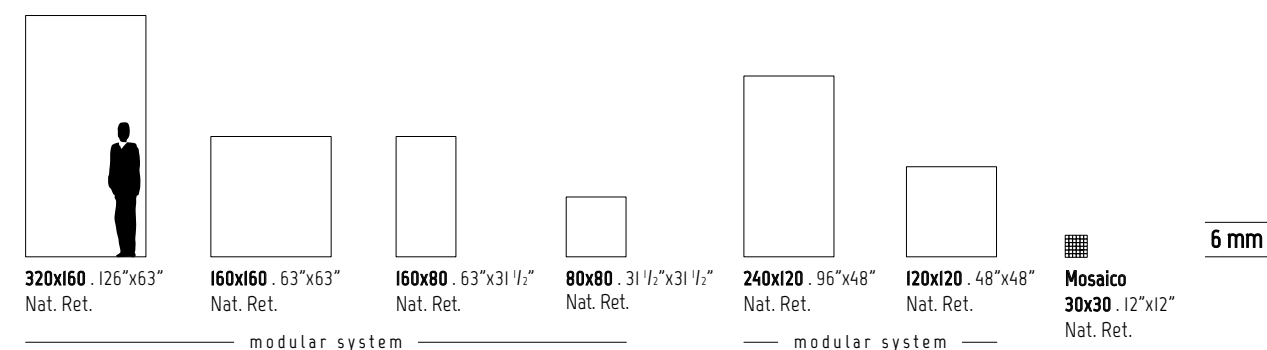

SVILUPPO GRAFICO PER FORMATO
 Pattern by size
 Développement graphique par format
 Grafischer Entwurf für Format
 Desarrollo gráfico por formato
 Варианты графики для каждого формата

320x160 6 mm	160x160 6 mm	160x80 6 mm	80x80 6 mm	240x120 6 mm	120x120 6 mm
7	14	28	56	9	18



Floor
Tortora 160x160 (63"x63") Nat. Ret.

DISTRICT

Wall
Bianco 320x160 (126"x63") Nat. Ret.

Banco bar / Bar counter
Bianco Nat. Ret.

Floor
Grigio 320x160 (126"x63") Nat. Ret.



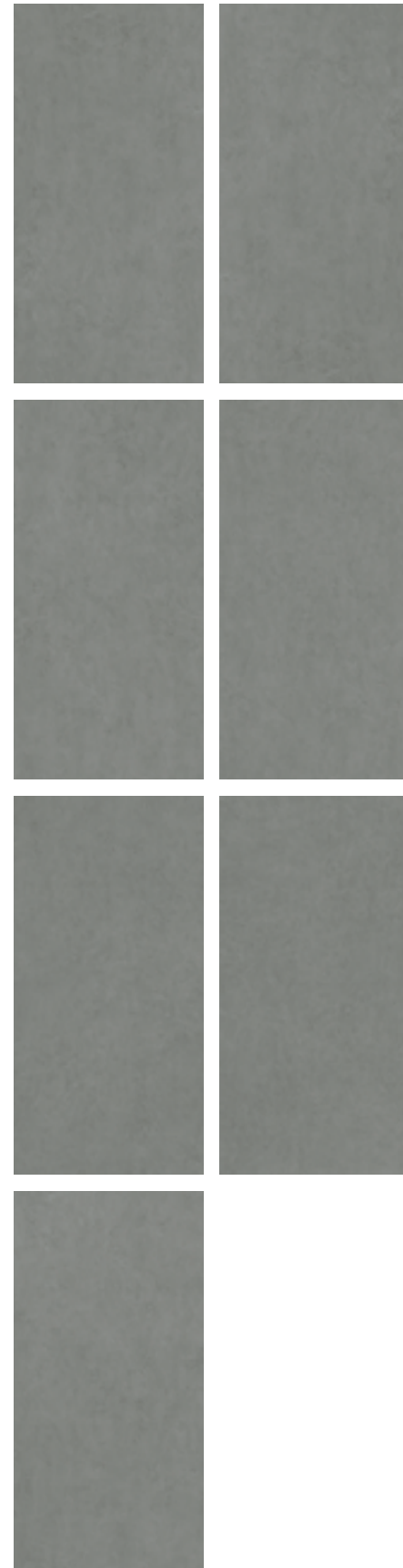

320x160
SVILUPPO GRAFICO PER FORMATO - 7 Pattern by size
7 Développement graphique par format - 7 Grafischer Entwurf für Format
7 Desarrollo gráfico por formato - 7 Варианты графики для каждого формата

6 mm

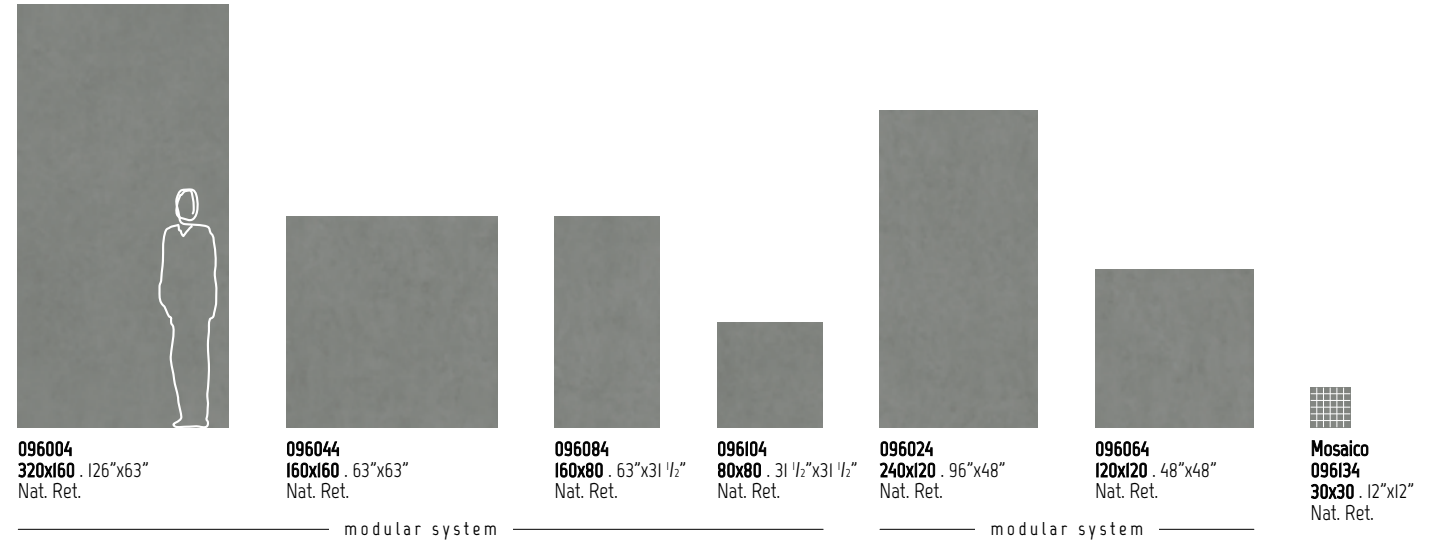

LA SERIE DISTRICT SI COMPLETA CON ALTRI FORMATI DEL CATALOGO LA FABBRICA: SERIE RESINE
The District series is completed with the other sizes which can be seen in the La Fabbrica catalogue: Resine series.
La série District est complétée par d'autres formats du catalogue La Fabbrica : série Resine.
Die Serie District wird durch andere Formate des Katalogs La Fabbrica: Serie Resine.
La serie District se completa con otros formatos del catálogo La Fabbrica: serie Resine.
Серия District дополняется другими форматами из каталога La Fabbrica: серия Resine.

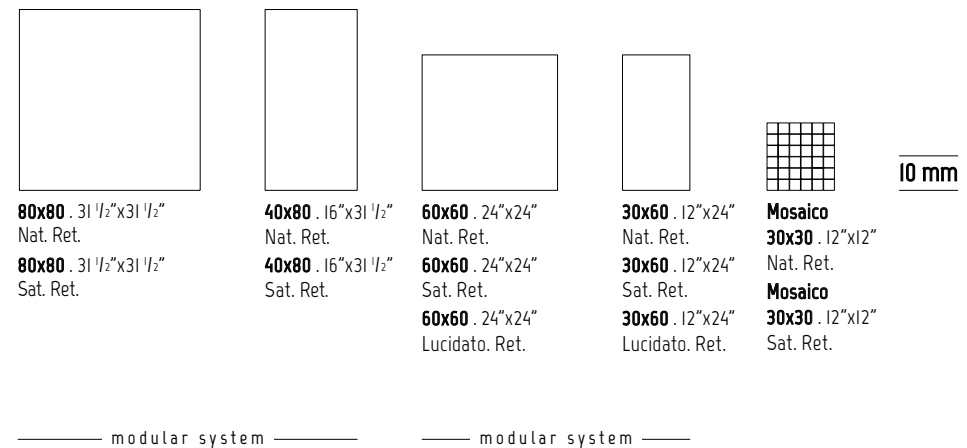

I VETTORIALI DEI FORMATI NON SONO IN SCALA CON QUELLI DI AVA
The vector images of the sizes shown here are not in scale with the AVA images.
Les vecteurs des formats présentés ici ne sont pas à l'échelle avec ceux d'AVA.
Die Vektorbilder der hier angegebenen Formate sind nicht maßstabsgetreu zu denen von AVA.
Los vectoriales de los formatos aquí indicados no están a escala con aquellos de AVA.
Масштаб векторных изображений указанных здесь форматов не совпадает с масштабом векторных изображений AVA.

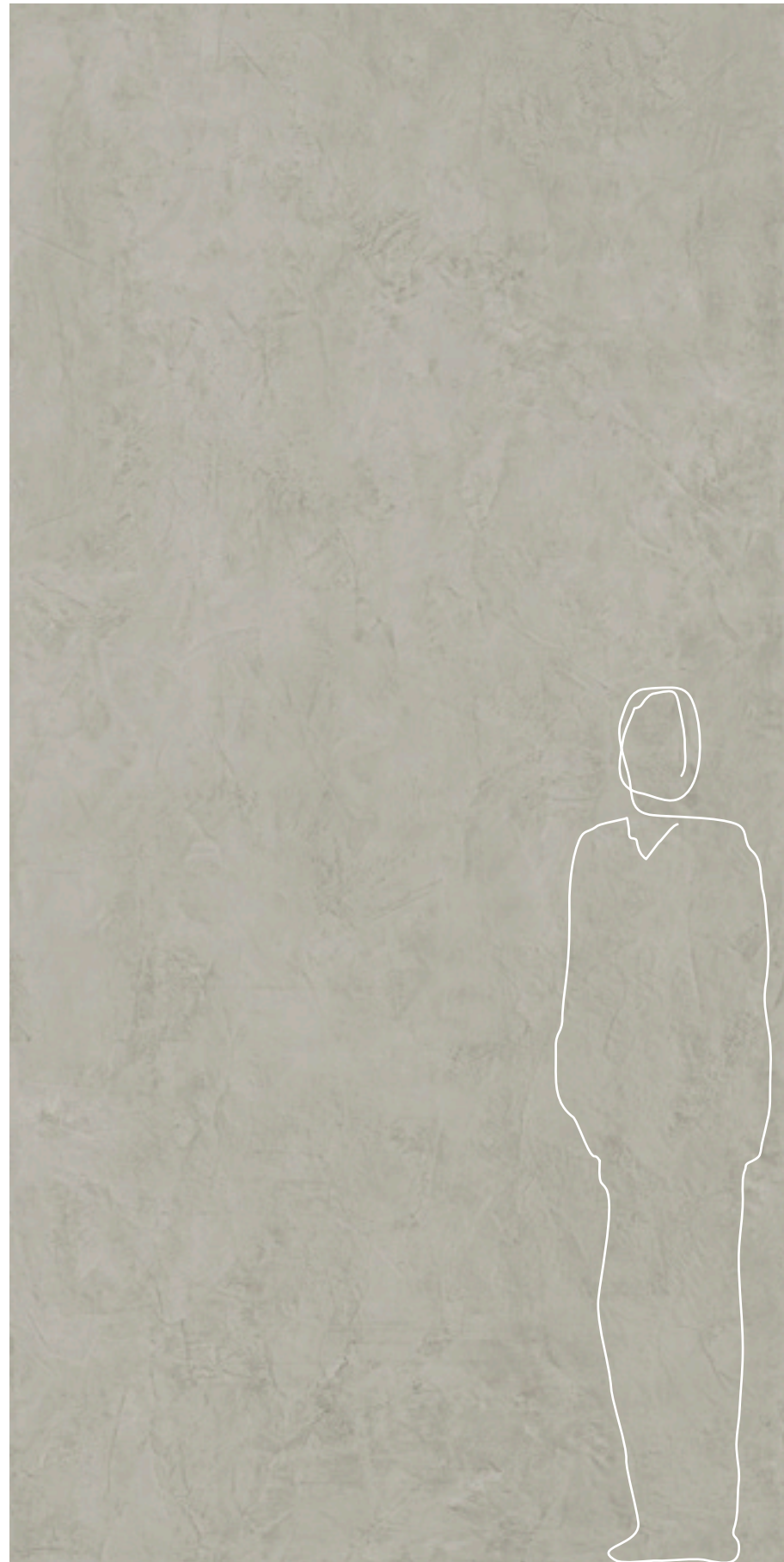

320x160
SVILUPPO GRAFICO PER FORMATO - 7 Pattern by size
 7 Développement graphique par format - 7 Grafischer Entwurf für Format
 7 Desarrollo gráfico por formato - 7 Варианты графики для каждого формата

6 mm

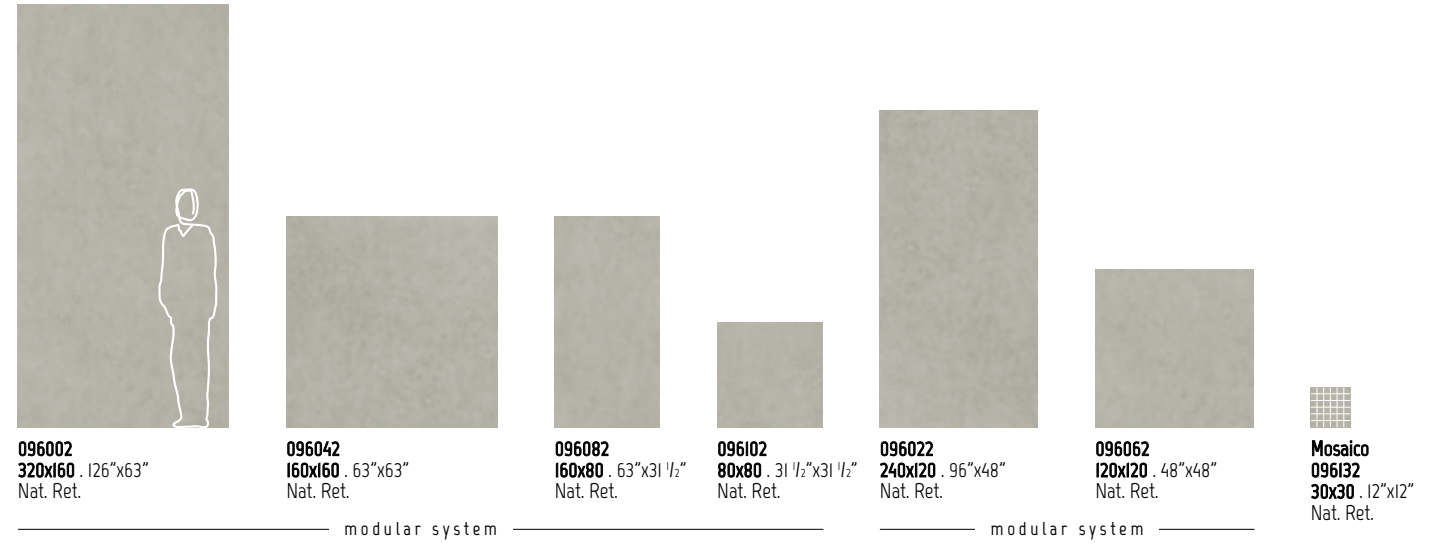

LA SERIE DISTRICT SI COMPLETA CON ALTRI FORMATI DEL CATALOGO LA FABBRICA: SERIE RESINE
 The District series is completed with the other sizes which can be seen in the La Fabbrica catalogue: Resine series.
 La série District est complétée par d'autres formats du catalogue La Fabbrica : série Resine.
 Die Serie District wird durch andere Formate des Katalogs La Fabbrica: Serie Resine.
 La serie District se completa con otros formatos del catálogo La Fabbrica: serie Resine.
 Серия District дополняется другими форматами из каталога La Fabbrica: серия Resine.

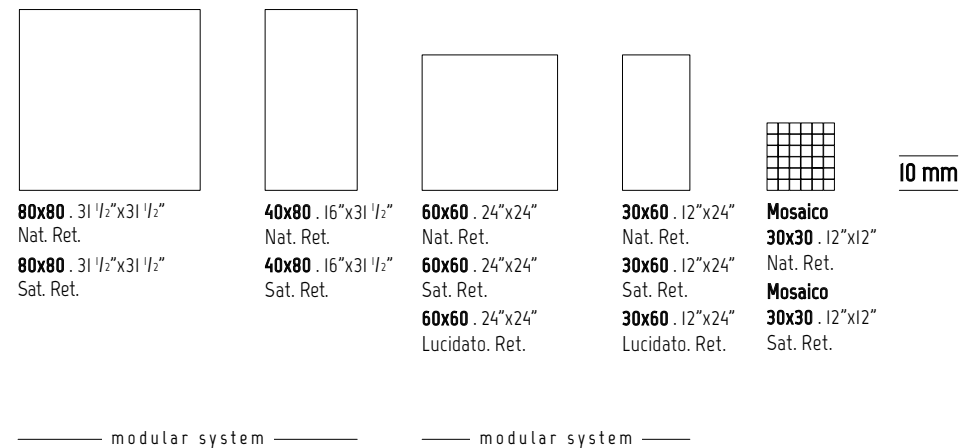

I VETTORIALI DEI FORMATI NON SONO IN SCALA CON QUELLI DI AVA
 The vector images of the sizes shown here are not in scale with the AVA images.
 Les vecteurs des formats présentés ici ne sont pas à l'échelle avec ceux d'AVA.
 Die Vektorbilder der hier angegebenen Formate sind nicht maßstabsgetreu zu denen von AVA.
 Los vectoriales de los formatos aquí indicados no están a escala con aquellos de AVA.
 Масштаб векторных изображений указанных здесь форматов не совпадает с масштабом векторных изображений AVA.



320x160
SVILUPPO GRAFICO PER FORMATO - 7 Pattern by size
 7 Développement graphique par format - 7 Grafischer Entwurf für Format
 7 Desarrollo gráfico por formato - 7 Варианты графики для каждого формата

6 mm

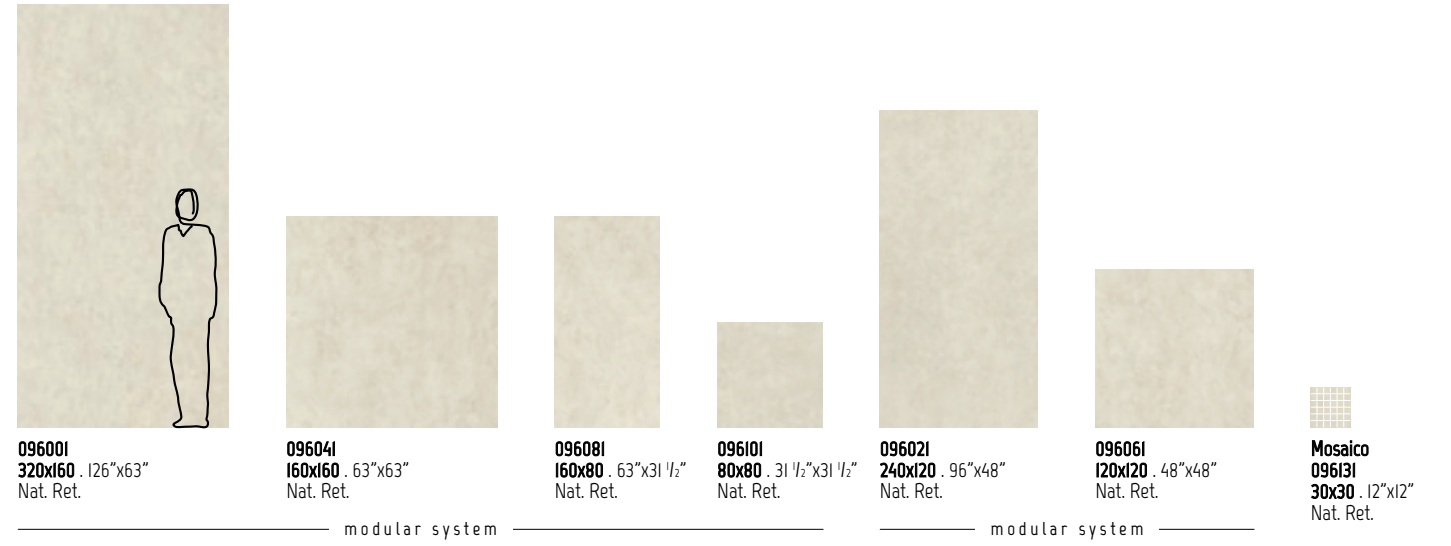

LA SERIE DISTRICT SI COMPLETA CON ALTRI FORMATI DEL CATALOGO LA FABBRICA: SERIE RESINE
 The District series is completed with the other sizes which can be seen in the La Fabbrica catalogue: Resine series.
 La série District est complétée par d'autres formats du catalogue La Fabbrica : série Resine.
 Die Serie District wird durch andere Formate des Katalogs La Fabbrica: Serie Resine.
 La serie District se completa con otros formatos del catálogo La Fabbrica: serie Resine.
 Серия District дополняется другими форматами из каталога La Fabbrica: серия Resine.

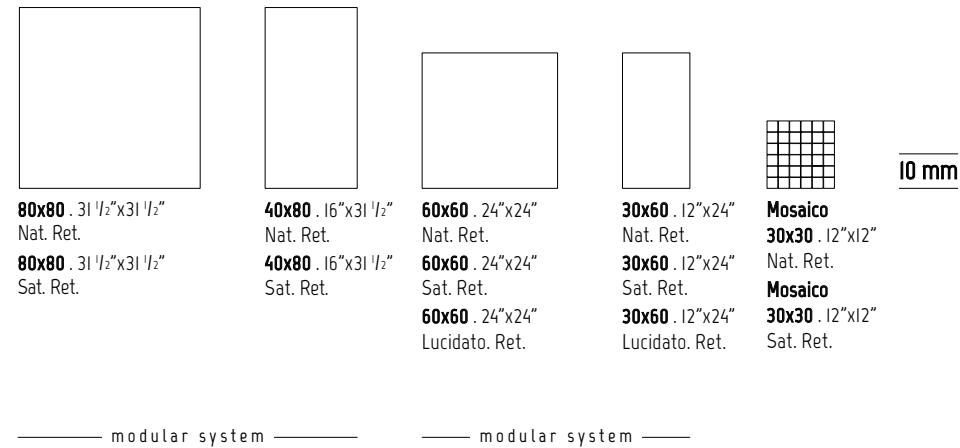

I VETTORIALI DEI FORMATI NON SONO IN SCALA CON QUELLI DI AVA
 The vector images of the sizes shown here are not in scale with the AVA images.
 Les vecteurs des formats présentés ici ne sont pas à l'échelle avec ceux d'AVA.
 Die Vektorbilder der hier angegebenen Formate sind nicht maßstabsgetreu zu denen von AVA.
 Los vectoriales de los formatos aquí indicados no están a escala con aquellos de AVA.
 Масштаб векторных изображений указанных здесь форматов не совпадает с масштабом векторных изображений AVA.

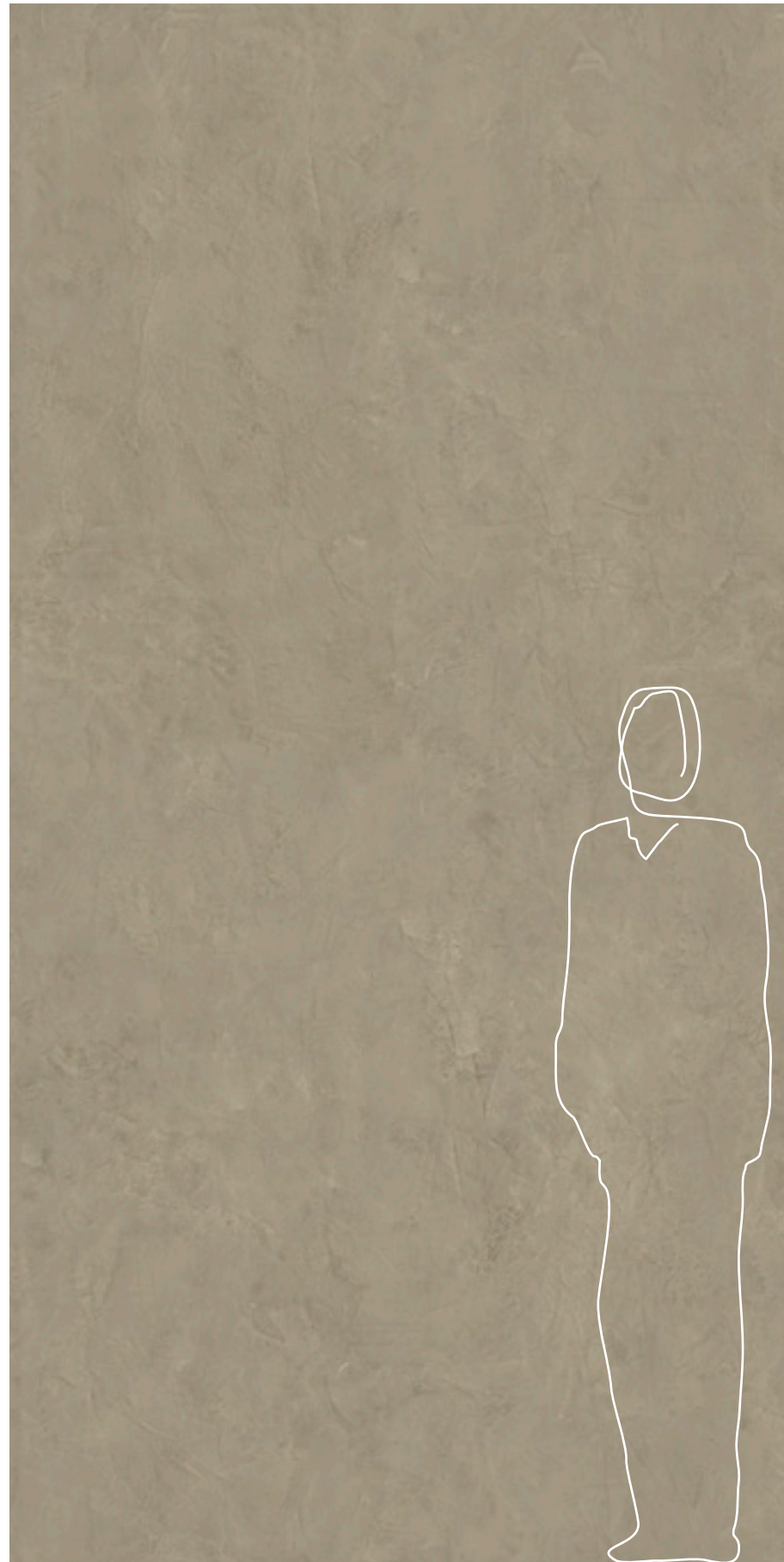

320x160
SVILUPPO GRAFICO PER FORMATO - 7 Pattern by size
 7 Développement graphique par format - 7 Grafischer Entwurf für Format
 7 Desarrollo gráfico por formato - 7 Варианты графики для каждого формата

6 mm

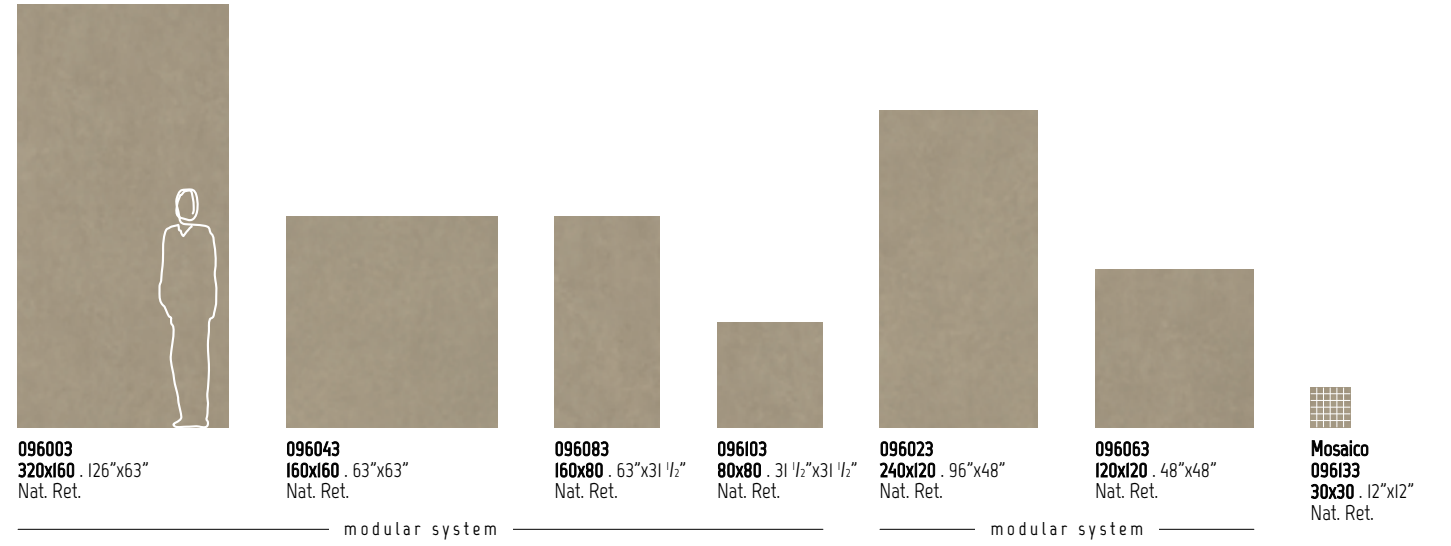

LA SERIE DISTRICT SI COMPLETA CON ALTRI FORMATI DEL CATALOGO LA FABBRICA: SERIE RESINE
 The District series is completed with the other sizes which can be seen in the La Fabbrica catalogue: Resine series.
 La série District est complétée par d'autres formats du catalogue La Fabbrica : série Resine.
 Die Serie District wird durch andere Formate des Katalogs La Fabbrica: Serie Resine.
 La serie District se completa con otros formatos del catálogo La Fabbrica: serie Resine.
 Серия District дополняется другими форматами из каталога La Fabbrica: серия Resine.

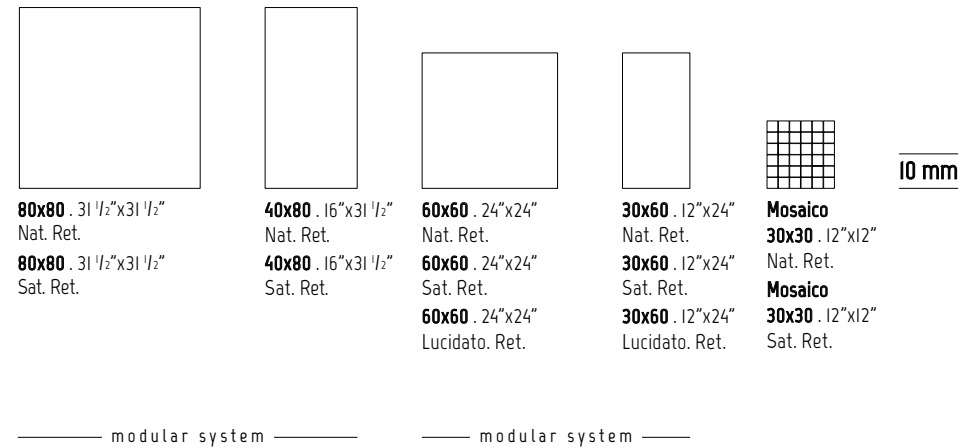

I VETTORIALI DEI FORMATI NON SONO IN SCALA CON QUELLI DI AVA
 The vector images of the sizes shown here are not in scale with the AVA images.
 Les vecteurs des formats présentés ici ne sont pas à l'échelle avec ceux d'AVA.
 Die Vektorbilder der hier angegebenen Formate sind nicht maßstabsgetreu zu denen von AVA.
 Los vectoriales de los formatos aquí indicados no están a escala con aquellos de AVA.
 Масштаб векторных изображений указанных здесь форматов не совпадает с масштабом векторных изображений AVA.

DISTRICT

6 mm

ANSI A - 137.1: 2012
WET DYNAMIC COEFFICIENT OF FRICTION
DCOF ≥ 0,42

	modular system					modular system					Mosaico Mosaic	Battiscopa Skirting	Scoretto Rabbeted riser	Gradino costa retta Straight nosed stair **			Gradino costa retta - Angolo SX / DX Straight-edge step - LH/RH corner **			Gradino Bordo Dritto Straight-edge step **			Gradino Bordo Dritto - Angolo SX / DX Straight-edge step - LH/RH corner **					
	320x160 126"x63" Nat. Ret.	160x160 63"x63" Nat. Ret.	160x80 63"x31 1/2" Nat. Ret.	80x80 31 1/2"x31 1/2" Nat. Ret.	240x120 96"x48" Nat. Ret.	120x120 48"x48" Nat. Ret.	30x30 12"x12" Nat. Ret.	8x80 3"x31 1/2" Nat. Ret.	20x160 8"x63" Nat. Ret.	20x80 8"x31 1/2" Nat. Ret.	33x160x3,2h 13"x63"x1 1/4" Nat. Ret.	33x120x3,2h 13"x48"x1 1/4" Nat. Ret.	33x80x3,2h 13"x31 1/2"x1 1/4" Nat. Ret.	33x160x3,2h 13"x63"x1 1/4" Nat. Ret.	33x120x3,2h 13"x48"x1 1/4" Nat. Ret.	33x80x3,2h 13"x31 1/2"x1 1/4" Nat. Ret.	30x160x4h 12"x63"x1 1/2" Nat. Ret.	30x120x4h 12"x48"x1 1/2" Nat. Ret.	30x80x4h 12"x31 1/2"x1 1/2" Nat. Ret.	30x160x4h 12"x63"x1 1/2" Nat. Ret.	30x120x4h 12"x48"x1 1/2" Nat. Ret.	30x80x4h 12"x31 1/2"x1 1/2" Nat. Ret.	30x160x4h 12"x63"x1 1/2" Nat. Ret.	30x120x4h 12"x48"x1 1/2" Nat. Ret.	30x80x4h 12"x31 1/2"x1 1/2" Nat. Ret.			
NERO	096004	096044	096084	096104	096024	096064	096134	096154	096163	096167	096204	096234	096251	096212 SX 096208 DX	096242 SX 096238 DX	096260 SX 096256 DX	096284	096276	096264	096292 SX 096288 DX	096296 SX 096280 DX	096272 SX 096268 DX						
GRIGIO	096002	096042	096082	096102	096022	096062	096132	096152	096161	096165	096202	096232	096252	096210 SX 096206 DX	096240 SX 096236 DX	096258 SX 096254 DX	096282	096274	096262	096290 SX 096286 DX	096294 SX 096278 DX	096270 SX 096266 DX						
BIANCO	096001	096041	096081	096101	096021	096061	096131	096151	096160	096164	096201	096231	096249	096209 SX 096205 DX	096239 SX 096235 DX	096257 SX 096253 DX	096281	096273	096261	096289 SX 096285 DX	096293 SX 096277 DX	096269 SX 096265 DX						
TORTORA	096003	096043	096083	096103	096023	096063	096133	096153	096162	096166	096203	096233	096250	096211 SX 096207 DX	096241 SX 096237 DX	096259 SX 096255 DX	096283	096275	096263	096291 SX 096287 DX	096295 SX 096279 DX	096271 SX 096267 DX						
PREZZO PRICE	€ 106,00 m ²	€ 94,00 m ²	€ 74,00 m ²	€ 62,00 m ²	€ 86,00 m ²	€ 74,00 m ²	€ 126,00 m ²	€ 7,00 PZ/PCE	€ 30,00 PZ/PCE	€ 22,00 PZ/PCE	€ 272,00 PZ/PCE	€ 176,00 PZ/PCE	€ 100,00 PZ/PCE	€ 304,00 PZ/PCE	€ 212,00 PZ/PCE	€ 136,00 PZ/PCE	€ 178,00 PZ/PCE	€ 126,00 PZ/PCE	€ 68,00 PZ/PCE	€ 240,00 PZ/PCE	€ 178,00 PZ/PCE	€ 116,00 PZ/PCE						
CODICE PREZZO PRICE CODE	M173	M161	M141	M129	M153	M141	M193	P025	P077	P061	P303	P243	P167	P319	P273	P203	P245	P193	P135	P287	P245	P183						
IMBALLO cm h. PACKING cm h.																												
Tara / Tare	140,00	210,00	71,80	210,00	-	20	100,00	158,00	-	158,00	-	-	-	-	-	-	-	-	-	-	-	-	-	-	-	-	-	
N°	14	44	24	88	-	-	20	44	-	88	-	-	-	-	-	-	-	-	-	-	-	-	-	-	-	-	-	
m ² x	5,12	5,12	2,56	2,56	-	-	2,88	2,88	-	1,44	-	-	-	-	-	-	-	-	-	-	-	-	-	-	-	-	-	
Kg x	74,14	74,14	37,07	37,07	-	-	41,70	41,70	-	20,85	-	-	-	-	-	-	-	-	-	-	-	-	-	-	-	-	-	
m ² x	-	-	-	-	2	3	-	-	2	-	-	12	1	1	1	2	2	1	1	1	1	2	2	1	1	1	1	
Kg x	-	-	-	-	37,2	27,90	-	-	41,70	-	-	11,50	5	3	9	14	10	10	10	7	6	8,5	13,5	9	9	9,5	7	5
m ² x	71,68	225,28	61,44	225,28	38,40	76,80	57,60	126,72	69,12	126,72	-	-	-	-	-	-	-	-	-	-	-	-	-	-	-	-	-	
Kg x	1.178	3.472	962	3.472	648	1.141	934	1.993	1.057	1.993	-	-	-	-	-	-	-	-	-	-	-	-	-	-	-	-	-	



Cavalletto in legno
Wood A-Frame
Support en bois
Holzgestell
Caballete de madera
Деревянная подставка



Cassa
Crate
Caisse
Kiste
Caja
Ящик



Pallet speciale con sponde
Special pallet with sides
Palette spéciale avec bords
Spezial-Palette mit Wandungen
Palet especial con bordes
Специальный поддон с боковинами

** PEZZI SPECIALI - A disposizione solo su richiesta. Tempi di consegna: 30gg.
TRIMS - Available upon request only. Delivery terms: 30 days.
PIÈCES SPECIALES - Disponible seulement sur requête. Délais de livraison: 30 jours.
FORMSTÜCKE - Verfügbar auf Anfrage. Lieferzeit: 30 Tage.
PIEZAS ESPECIALES - Disponible sólo bajo pedido. Plazo de entrega: 30 días.
СПЕЦИАЛЬНЫЕ ЭЛЕМЕНТЫ - Изготавливается только по специальной заявке. Срок поставки: 30 дней.

METAL

BLADE

CORTEN

GREIGE

PEARL

LASTRE IN GRES PORCELLANATO PRESSATE A SECCO . DRY-PRESSED PORCELAIN STONWARE SLABS .
 DALLES EN GRES CÉRAMÉ PRESSÉES À SEC . TROCKENGEPRESSTE PLATTEN AUS FEINSTEINZEUG .
 PLANCHAS EN GRES PORCELÁNICO PRENSADAS EN SECO . КЕРАМОГРАНИТНЫЕ ПЛИТЫ СУХОГО ПРЕССОВАНИЯ .
 UNI EN 14411-ISO 13006 - Appendice C - Gruppo BIa - UGL

100% DESIGN
AND PRODUCTION
OF ITALY

V2
SHADE SPECTRUM
MODERATE

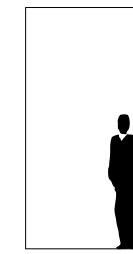

320x160 . 126"x63"
Nat. Ret.

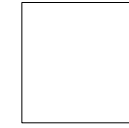

160x160 . 63"x63"
Nat. Ret.



160x80 . 63"x31 1/2"
Nat. Ret.



80x80 . 31 1/2"x31 1/2"
Nat. Ret.



280x120 . 110"x48"
Nat. Ret.



Mosaico
30x30 . 12"x12"
Nat. Ret.

6 mm

modular system

INDOOR



120x60 . 48"x24"
Nat. Ret.

10 mm

SVILUPPO GRAFICO PER FORMATO
 Pattern by size
 Développement graphique par format
 Grafischer Entwurf für Format
 Desarrollo gráfico por formato
 Варианты графики для каждого формата

320x160
6 mm

160x160
6 mm

160x80
6 mm

80x80
6 mm

280x120
6 mm

120x60
10 mm

7

14

28

56

11

16

METAL

Wall
Corten 320x160 (126"x63") Nat. Ret.
La Fabbrica: Sahara Noir 120x60 (48"x24") Nat. Ret.

Floor
Pearl 160x160 (63"x63") Nat. Ret.





Wall
Corten 280x120 (110"x48") Nat. Ret.
Greige 280x120 (110"x48") Nat. Ret.
Mosaico Corten 30x30 (12"x12") Nat. Ret.

Floor
Corten 280x120 (110"x48") Nat. Ret.

Elementi sospesi / Hanging
Blade, Collection Marmi: Statuario

Floor
Blade 320x160 (126"x63") Nat. Ret.



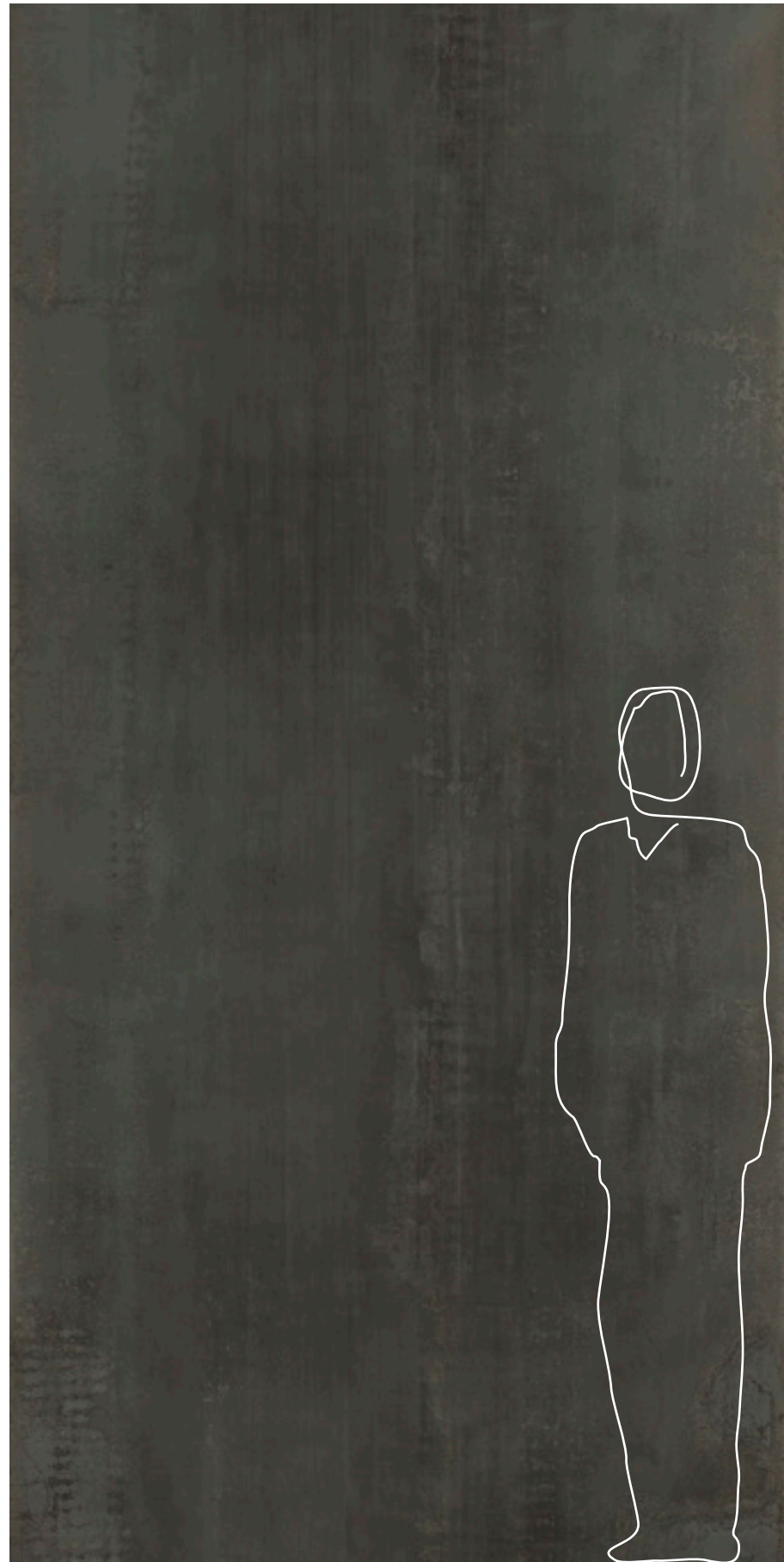

320x160
 SVILUPPO GRAFICO PER FORMATO - 7 Pattern by size
 7 Développement graphique par format - 7 Grafischer Entwurf für Format
 7 Desarrollo gráfico por formato - 7 Варианты графики для каждого формата

6 mm



I40004
320x160 . 126"x63"
 Nat. Ret.

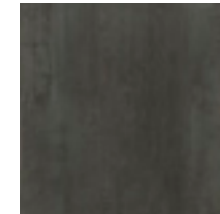

I40044
160x160 . 63"x63"
 Nat. Ret.



I40084
160x80 . 63"x31 1/2"
 Nat. Ret.

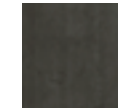

I40104
80x80 . 31 1/2"x31 1/2"
 Nat. Ret.



I40024
280x120 . 110"x48"
 Nat. Ret.



Mosaico
I40304
30x30 . 12"x12"
 Nat. Ret.

modular system

INDOOR

10 mm

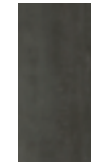

I40124
120x60 . 48"x24"
 Nat. Ret.



320x160
 SVILUPPO GRAFICO PER FORMATO - 7 Pattern by size
 7 Développement graphique par format - 7 Grafischer Entwurf für Format
 7 Desarrollo gráfico por formato - 7 Варианты графики для каждого формата

6 mm



I40003
320x160 . 126"x63"
 Nat. Ret.



I40043
160x160 . 63"x63"
 Nat. Ret.



I40083
160x80 . 63"x31 1/2"
 Nat. Ret.

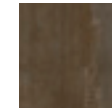

I40103
80x80 . 31 1/2"x31 1/2"
 Nat. Ret.



I40023
280x120 . 110"x48"
 Nat. Ret.



Mosaico
I40303
30x30 . 12"x12"
 Nat. Ret.

modular system

INDOOR

10 mm

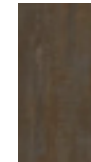

I40123
120x60 . 48"x24"
 Nat. Ret.



320x160
 SVILUPPO GRAFICO PER FORMATO - 7 Pattern by size
 7 Développement graphique par format - 7 Grafischer Entwurf für Format
 7 Desarrollo gráfico por formato - 7 Варианты графики для каждого формата

6 mm



I40002
320x160 . 126"x63"
 Nat. Ret.

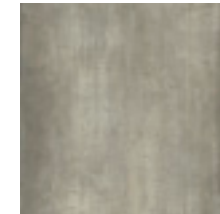

I40042
160x160 . 63"x63"
 Nat. Ret.



I40082
160x80 . 63"x31 1/2"
 Nat. Ret.

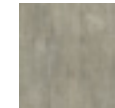

I40102
80x80 . 31 1/2"x31 1/2"
 Nat. Ret.



I40022
280x120 . 110"x48"
 Nat. Ret.



Mosaico
I40302
30x30 . 12"x12"
 Nat. Ret.

modular system

INDOOR

10 mm



I40122
120x60 . 48"x24"
 Nat. Ret.



320x160
 SVILUPPO GRAFICO PER FORMATO - 7 Pattern by size
 7 Développement graphique par format - 7 Grafischer Entwurf für Format
 7 Desarrollo gráfico por formato - 7 Варианты графики для каждого формата

6 mm

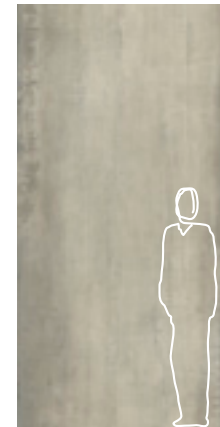

140001
320x160 . 126"x63"
 Nat. Ret.

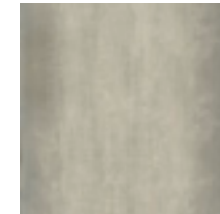

140041
160x160 . 63"x63"
 Nat. Ret.



140081
160x80 . 63"x31 1/2"
 Nat. Ret.



140101
80x80 . 31 1/2"x31 1/2"
 Nat. Ret.



140021
280x120 . 110"x48"
 Nat. Ret.



Mosaico
140301
30x30 . 12"x12"
 Nat. Ret.

modular system

INDOOR

10 mm













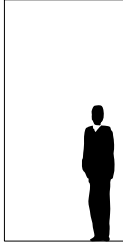

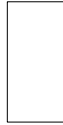

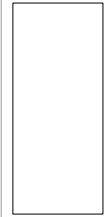

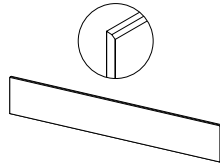

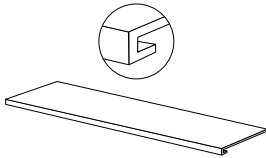
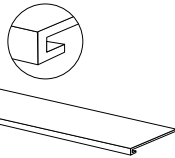
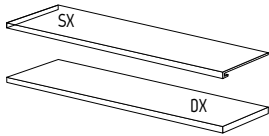
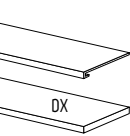
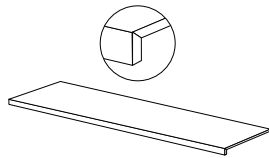

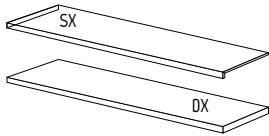
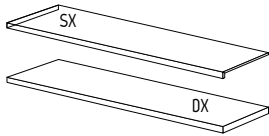









140121
120x60 . 48"x24"
 Nat. Ret.

METAL

6 mm

modular system

ANSI A - 137.1: 2012
WET DYNAMIC COEFFICIENT OF FRICTION | DCOF ≥ 0,42

	modular system				Mosaico Mosaic	Battiscopa Skirting	Scuretto Rabbeted riser	Gradino costa retta Straight nosed stair **	Gradino costa retta - Angolo SX / DX Straight-edge step - LH/RH corner **	Gradino Bordo Dritto Straight-edge step **	Gradino Bordo Dritto - Angolo SX / DX Straight-edge step - LH/RH corner **									
	 320x160 126"x63" Nat. Ret.	 160x160 63"x63" Nat. Ret.	 160x80 63"x31 1/2" Nat. Ret.	 80x80 31 1/2"x31 1/2" Nat. Ret.	 280x120 110"x48" Nat. Ret.	 30x30 12"x12" Nat. Ret.	 8x80 3"x31 1/2" Nat. Ret.	 20x160 8"x63" Nat. Ret.	 20x80 8"x31 1/2" Nat. Ret.	 33x160x3,2h 13"x63"x1 1/4" Nat. Ret.	 33x80x3,2h 13"x31 1/2"x1 1/4" Nat. Ret.	 33x160x3,2h 13"x63"x1 1/4" Nat. Ret.	 33x80x3,2h 13"x31 1/2"x1 1/4" Nat. Ret.	 30x160x4h 12"x63"x1 1/2" Nat. Ret.	 30x80x4h 12"x31 1/2"x1 1/2" Nat. Ret.	 30x160x4h 12"x63"x1 1/2" Nat. Ret.	 30x80x4h 12"x31 1/2"x1 1/2" Nat. Ret.			
	BLADE	CORTEN	GREIGE	PEARL	PREZZO PRICE	CODICE PREZZO PRICE CODE														
	140004	140044	140084	140104	140024	140304	140212	140220	140236	140324	140348	140340 SX 140332 DX	140364 SX 140356 DX	140396	140420	140412 SX 140404 DX	140436 SX 140428 DX			
	140003	140043	140083	140103	140023	140303	140211	140219	140235	140323	140347	140339 SX 140331 DX	140363 SX 140355 DX	140395	140419	140411 SX 140403 DX	140435 SX 140427 DX			
	140002	140042	140082	140102	140022	140302	140210	140218	140234	140322	140346	140338 SX 140330 DX	140362 SX 140354 DX	140394	140418	140410 SX 140402 DX	140434 SX 140426 DX			
	140001	140041	140081	140101	140021	140301	140209	140217	140233	140321	140345	140337 SX 140329 DX	140361 SX 140353 DX	140393	140417	140409 SX 140401 DX	140433 SX 140425 DX			
	€ 106,00 m ²	€ 94,00 m ²	€ 74,00 m ²	€ 62,00 m ²	€ 86,00 m ²	€ 126,00 m ²	€ 7,00 PZ/PCE	€ 30,00 PZ/PCE	€ 22,00 PZ/PCE	€ 272,00 PZ/PCE	€ 100,00 PZ/PCE	€ 304,00 PZ/PCE	€ 136,00 PZ/PCE	€ 178,00 PZ/PCE	€ 68,00 PZ/PCE	€ 240,00 PZ/PCE	€ 116,00 PZ/PCE			
	M173	M161	M141	M129	M153	M193	P025	P077	P061	P303	P167	P319	P203	P245	P135	P287	P183			
	 345x175	 330x75	 182,6x173,6	 330x75	 168x97	EPAL 80x120	 302x136	 330x75	EPAL 80x120	Pallet 80x120	 168x97	Pallet 80x120	 168x97	Pallet 80x120	 168x97	Pallet 80x120	 168x97	Pallet 80x120	 168x97	Pallet 80x120
IMBALLO cm h. PACKING cm h.	37	193,5	40,4	193,5	40,9	-	33,8	193,5	-	-	40,9	-	40,9	-	40,9	-	40,9	-	-	-
Tara / Tare	140,00	210,00	71,80	210,00	-	20	108,00	210,00	-	-	-	-	-	-	-	-	-	-	-	-
N°	14	44	24	88	-	-	20	44	-	-	-	-	-	-	-	-	-	-	-	-
m ² x	5,12	5,12	2,56	2,56	-	-	3,36	3,36	-	-	-	-	-	-	-	-	-	-	-	-
Kg x	74,14	74,14	37,07	37,07	-	-	48,65	48,65	-	-	-	-	-	-	-	-	-	-	-	-
 x 	-	-	-	-	2	3	-	-	-	12	1	1	1	2	1	1	1	2	1	1
m ² x 	-	-	-	-	2,56	1,92	-	-	-	0,77	-	-	-	-	-	-	-	-	-	-
Kg x 	-	-	-	-	37,2	27,90	-	-	-	11,50	5	3	9	10	10	6	8,5	9	9,5	5
 x 	-	-	-	-	15	40	-	-	-	-	-	-	-	-	-	-	-	-	-	-
m ² x 	71,68	225,28	61,44	225,28	38,40	76,80	67,2	147,84	-	-	-	-	-	-	-	-	-	-	-	-
Kg x 	1.178	3.472	962	3.472	648	1.141	1.081	2.350	-	-	-	-	-	-	-	-	-	-	-	-



Cavalletto in legno
Wood A-Frame
Support en bois
Holzgestell
Caballete de madera
Деревянная подставка



Cassa
Crate
Caisse
Kiste
Caja
Ящик















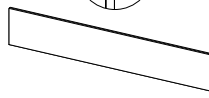
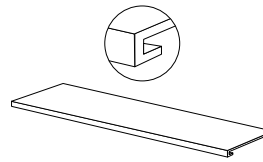
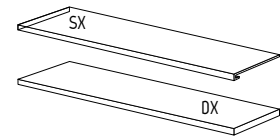
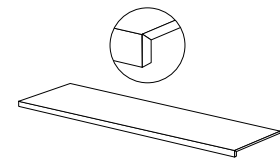
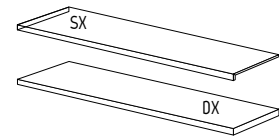

Pallet speciale con sponde
Special pallet with sides
Palette spéciale avec bords
Spezial-Palette mit Wandungen
Palet especial con bordes
Специальный поддон с боковинами

** PEZZI SPECIALI - A disposizione solo su richiesta. Tempi di consegna: 30gg.
TRIMS - Available upon request only. Delivery terms: 30 days.
PIÈCES SPECIALES - Disponible seulement sur requête. Délais de livraison: 30 jours.
FORMSTÜCKE - Verfügbar auf Anfrage. Lieferzeit: 30 Tage.
PIEZAS ESPECIALES - Disponible sólo bajo pedido. Plazo de entrega: 30 días.
СПЕЦИАЛЬНЫЕ ЭЛЕМЕНТЫ - Изготавливается только по специальной заявке. Срок поставки: 30 дней.

METAL INDOOR

10 mm

ANSI A - 137.1: 2012
WET DYNAMIC COEFFICIENT OF FRICTION | DCOF ≥ 0,42

	 120x60 48"x24" Nat. Ret.	 6,5x120 2 1/2"x48" Nat. Ret.	 20x120 8"x48" Nat. Ret.	 33x120x3,2h 13"x48"x1 1/4"h Nat. Ret.	 33x120x3,2h 13"x48"x1 1/4"h Nat. Ret.	 30x120x4h 12"x48"x1 1/2"h Nat. Ret.	 30x120x4h 12"x48"x1 1/2"h Nat. Ret.
BLADE 	I40124	I40204	I40228	I40372	I40388 SX I40380 DX	I40444	I42461 SX I42453 DX
CORTEN 	I40123	I40203	I40227	I40371	I40387 SX I40379 DX	I40443	I42460 SX I42452 DX
GREIGE 	I40122	I40202	I40226	I40370	I40386 SX I40378 DX	I40442	I42459 SX I42451 DX
PEARL 	I40121	I40201	I40225	I40369	I40385 SX I40377 DX	I40441	I42458 SX I42450 DX
PREZZO PRICE	€ 46,00 m ²	€ 8,00 PZ/PCE	€ 26,00 PZ/PCE	€ 140,00 PZ/PCE	€ 164,00 PZ/PCE	€ 106,00 PZ/PCE	€ 134,00 PZ/PCE
CODICE PREZZO PRICE CODE	M109	P029	P069	P207	P231	P173	P201
	EPAL 80x120	Pallet 80x120	Pallet 80x120	Pallet 80x120	Pallet 80x120	Pallet 80x120	Pallet 80x120
IMBALLO cm h. PACKING cm h.	-	-	-	-	-	-	-
Tara / Tare	20	-	-	-	-	-	-
 x 	2	6	1	2	1	2	1
m ² x 	1,44	-	-	-	-	-	-
Kg x 	33,41	11,4	12	22	11	22	11
 x 	30	-	-	-	-	-	-
m ² x 	43,2	-	-	-	-	-	-
Kg x 	1.025	-	-	-	-	-	-

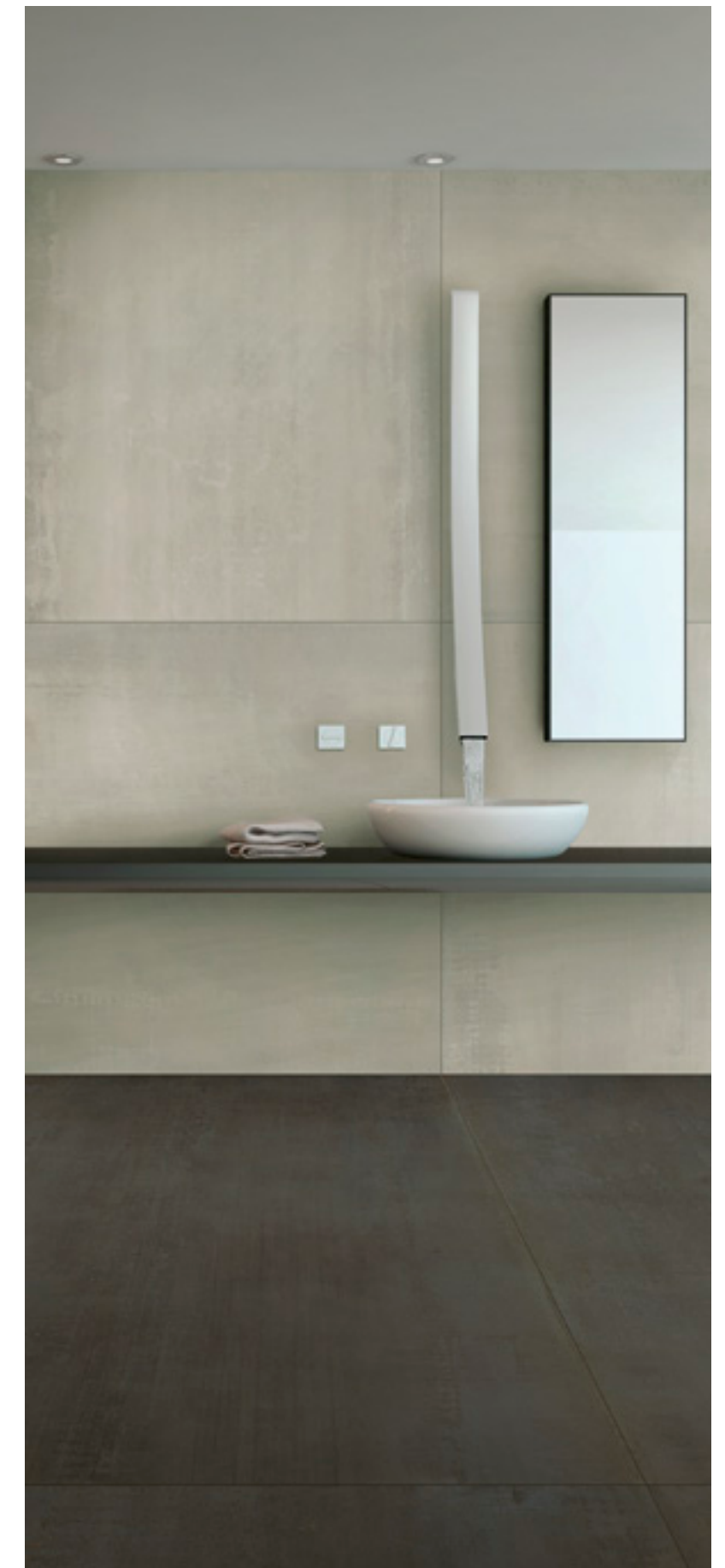

Wall
Pearl 160x160 (63"x63") Nat. Ret.

Floor
Blade 320x160 (126"x63") Nat. Ret.

**

PEZZI SPECIALI - A disposizione solo su richiesta. Tempi di consegna: 30gg.

TRIMS - Available upon request only. Delivery terms: 30 days.

PIÈCES SPECIALES - Disponible seulement sur requête. Délais de livraison: 30 jours.

FORMSTÜCKE - Verfügbar auf Anfrage. Lieferzeit: 30 Tage.

PIEZAS ESPECIALES - Disponible sólo bajo pedido. Plazo de entrega: 30 días.

СПЕЦИАЛЬНЫЕ ЭЛЕМЕНТЫ - Изготавливается только по специальной заявке. Срок поставки: 30 дней.

SKYLINE

ANTRACITE

FUMO

CHIACCIO

BEIGE

LASTRE IN GRES PORCELLANATO PRESSATE A SECCO . DRY-PRESSED PORCELAIN STONEWARE SLABS .
 DALLES EN GRÈS CÉRAME PRESSÉES À SEC . TROCKENGEPRESSTE PLATTEN AUS FEINSTEINZEUG .
 PLANCHAS EN GRÈS PORCELÁNICO PRENSADAS EN SECO . КЕРАМОГРАНИТНЫЕ ПЛИТЫ СУХОГО ПРЕССОВАНИЯ .
 UNI EN 14411-ISO 13006 - Appendice C - Gruppo BIa - UGL

100% DESIGN
AND PRODUCTION
OF ITALY

V2
SHADE SPECTRUM
MODERATE

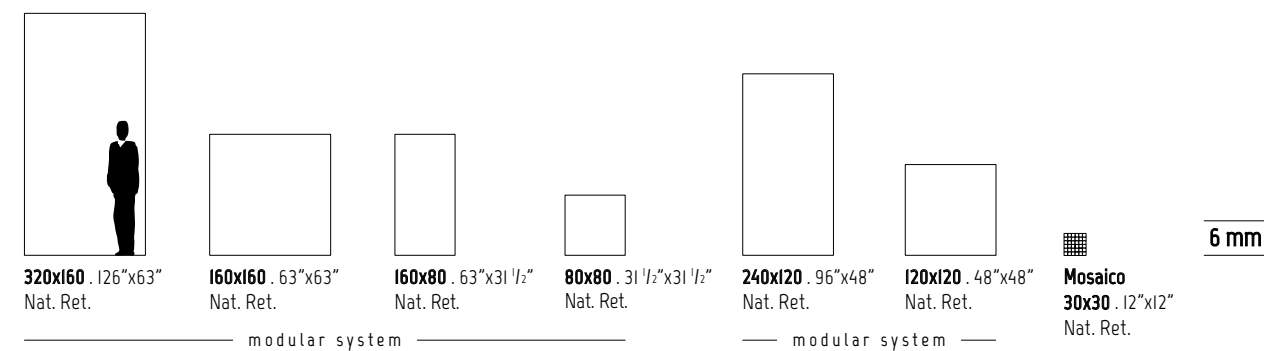

INDOOR

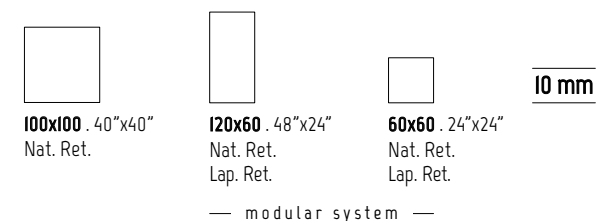

OUTDOOR R11-C

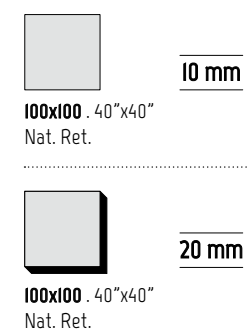

SVILUPPO GRAFICO PER FORMATO Pattern by size Développement graphique par format Grafischer Entwurf für Format Desarrollo gráfico por formato Варианты графики для каждого формата	320x160 6 mm	160x160 6 mm	160x80 6 mm	80x80 6 mm	240x120 6 mm	120x120 6 mm	100x100 10 mm 20 mm	120x60 10 mm	60x60 10 mm
	7	14	28	56	11	22	14	23	56



Wall
Fumo 240x120 (96"x48") Nat. Ret.
Beige 240x120 (96"x48") Nat. Ret.

Floor
Beige 240x120 (96"x48") Nat. Ret.



< Wall
 Beige 320x160 (126"x63") Nat. Ret.
 Floor
 Beige 100x100 (40"x40") Nat. Ret.

Wall
 Antracite 320x160 (126"x63") Nat. Ret.
 Chiaccio 320x160 (126"x63") Nat. Ret.
 Counter
 Chiaccio 320x160 (126"x63") Nat. Ret.
 Floor
 Antracite 320x160 (126"x63") Nat. Ret.

Floor
Fumo 320x160 (126"x63") Nat. Ret.



ANTRACITE

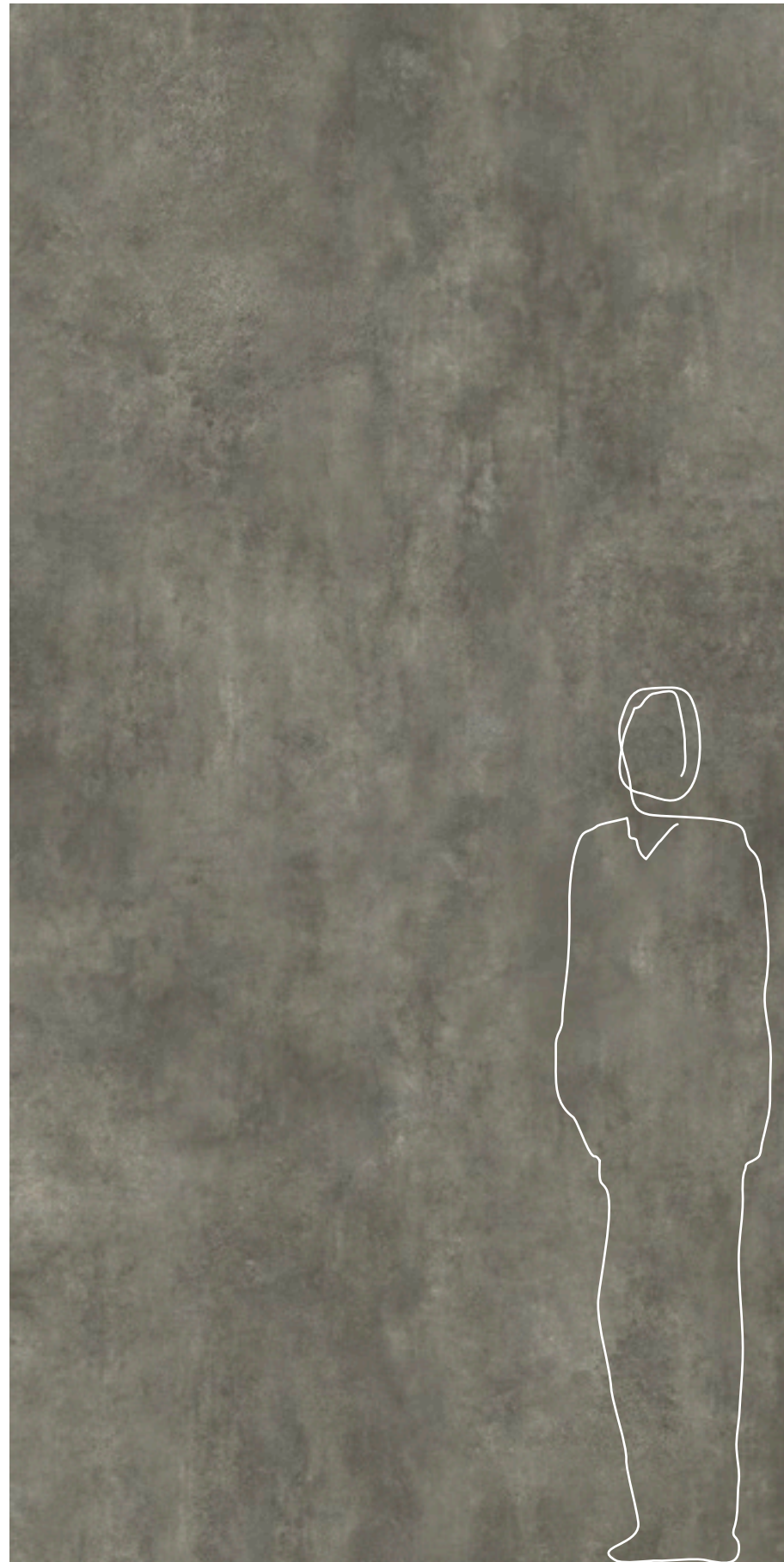

320x160
SVILUPPO GRAFICO PER FORMATO - 7 Pattern by size
7 Développement graphique par format - 7 Grafischer Entwurf für Format
7 Desarrollo gráfico por formato - 7 Варианты графики для каждого формата

6 mm



082010
320x160 . 126"x63"
Nat. Ret.



082050
160x160 . 63"x63"
Nat. Ret.

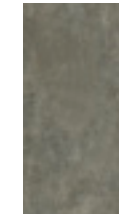

082090
160x80 . 63"x31 1/2"
Nat. Ret.

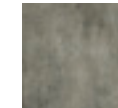

082110
80x80 . 31 1/2"x31 1/2"
Nat. Ret.



082030
240x120 . 96"x48"
Nat. Ret.



082070
120x120 . 48"x48"
Nat. Ret.



Mosaic
082189
30x30 . 12"x12"
Nat. Ret.

modular system

modular system

INDOOR

10 mm

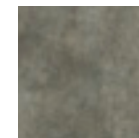

082094
100x100 . 40"x40"
Nat. Ret.



082130
120x60 . 48"x24"
Nat. Ret.



082150
60x60 . 24"x24"
Nat. Ret.

082131
120x60 . 48"x24"
Lap. Ret.

082151
60x60 . 24"x24"
Lap. Ret.

modular system

OUTDOOR

10 mm RII-C

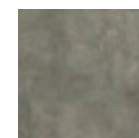

082098
100x100 . 40"x40"
Nat. Ret.

20 mm RII-C

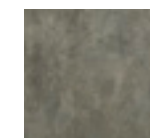

082114
100x100 . 40"x40"
Nat. Ret.

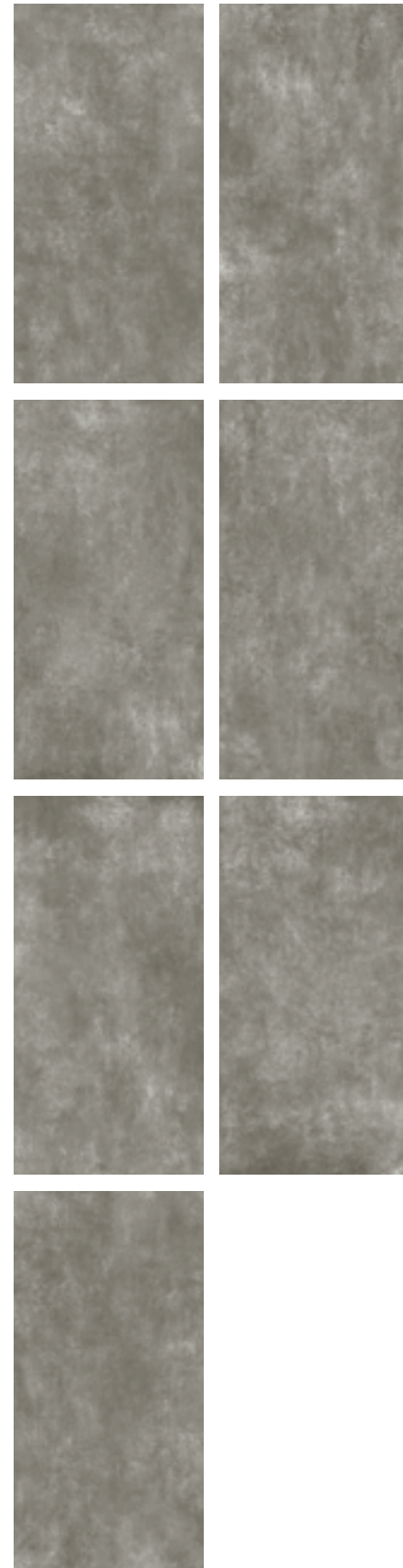

320x160
 SVILUPPO GRAFICO PER FORMATO - 7 Pattern by size
 7 Développement graphique par format - 7 Grafischer Entwurf für Format
 7 Desarrollo gráfico por formato - 7 Варианты графики для каждого формата

6 mm



082007
320x160 . 126"x63"
 Nat. Ret.



082047
160x160 . 63"x63"
 Nat. Ret.



082087
160x80 . 63"x31 1/2"
 Nat. Ret.

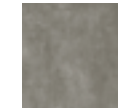

082107
80x80 . 31 1/2"x31 1/2"
 Nat. Ret.



082027
240x120 . 96"x48"
 Nat. Ret.



082067
120x120 . 48"x48"
 Nat. Ret.



Mosaico
082185
30x30 . 12"x12"
 Nat. Ret.

modular system

modular system

INDOOR

10 mm



082091
100x100 . 40"x40"
 Nat. Ret.



082127
120x60 . 48"x24"
 Nat. Ret.



082147
60x60 . 24"x24"
 Nat. Ret.

082128
120x60 . 48"x24"
 Lap. Ret.

082148
60x60 . 24"x24"
 Lap. Ret.

— modular system —

OUTDOOR

10 mm RII-C



082095
100x100 . 40"x40"
 Nat. Ret.

20 mm RII-C



082111
100x100 . 40"x40"
 Nat. Ret.

GHIACCIO



320x160
SVILUPPO GRAFICO PER FORMATO - 7 Pattern by size
 7 Développement graphique par format - 7 Grafischer Entwurf für Format
 7 Desarrollo gráfico por formato - 7 Варианты графики для каждого формата

6 mm

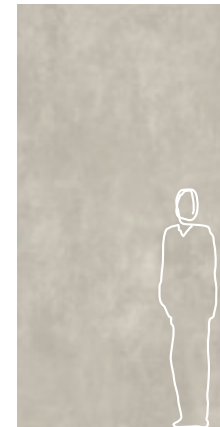

082001
320x160 . 126"x63"
 Nat. Ret.

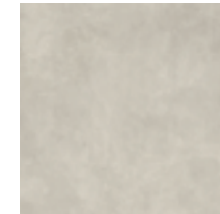

082041
160x160 . 63"x63"
 Nat. Ret.

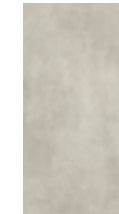

082081
160x80 . 63"x31 1/2"
 Nat. Ret.



082101
80x80 . 31 1/2"x31 1/2"
 Nat. Ret.



082021
240x120 . 96"x48"
 Nat. Ret.



082061
120x120 . 48"x48"
 Nat. Ret.



Mosaico
082181
30x30 . 12"x12"
 Nat. Ret.

modular system

modular system

INDOOR

10 mm



082093
100x100 . 40"x40"
 Nat. Ret.



082121
120x60 . 48"x24"
 Nat. Ret.



082141
60x60 . 24"x24"
 Nat. Ret.

082122
120x60 . 48"x24"
 Lap. Ret.

082142
60x60 . 24"x24"
 Lap. Ret.

modular system

OUTDOOR

10 mm RII-C



082097
100x100 . 40"x40"
 Nat. Ret.

20 mm RII-C

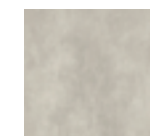

082113
100x100 . 40"x40"
 Nat. Ret.



320x160
 SVILUPPO GRAFICO PER FORMATO - 7 Pattern by size
 7 Développement graphique par format - 7 Grafischer Entwurf für Format
 7 Desarrollo gráfico por formato - 7 Варианты графики для каждого формата

6 mm

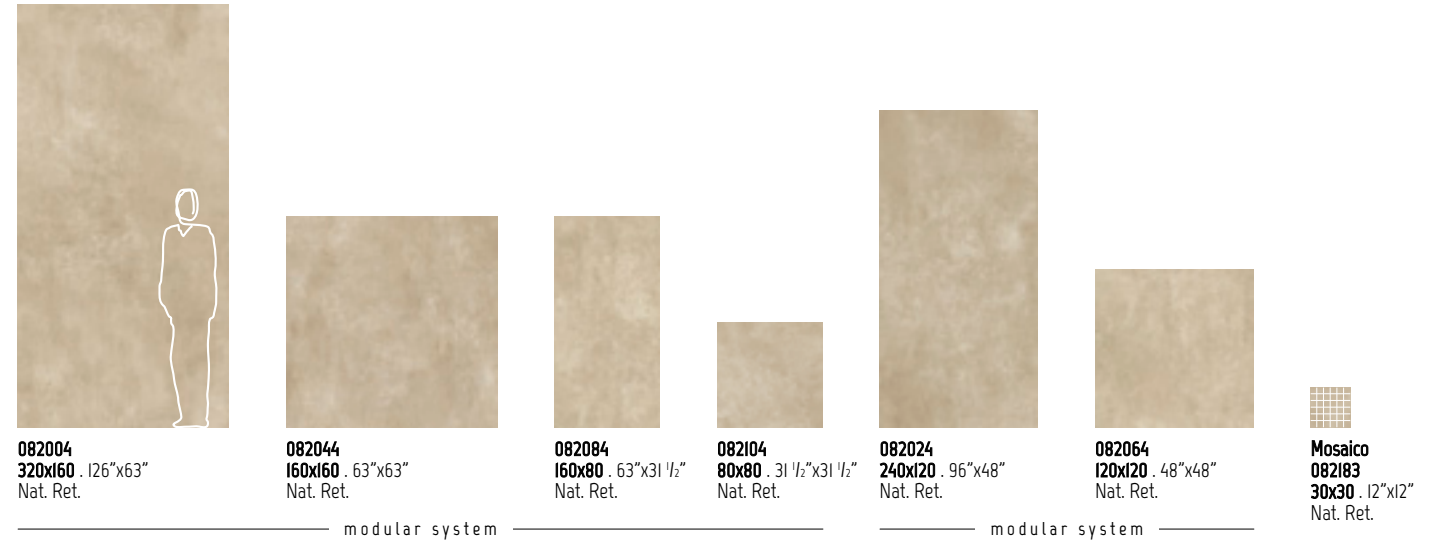

INDOOR

10 mm

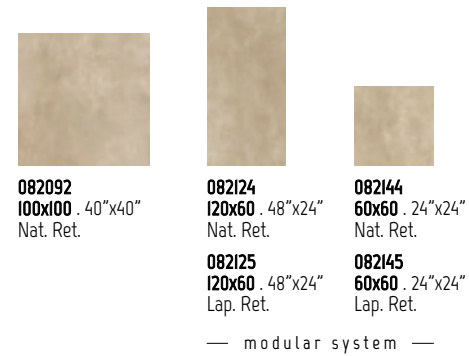

OUTDOOR

10 mm RII-C



082096
 100x100 . 40"x40"
 Nat. Ret.

20 mm RII-C



082112
 100x100 . 40"x40"
 Nat. Ret.

6 mm

ANSI A - 137.1: 2012
WET DYNAMIC COEFFICIENT OF FRICTION
DCOF ≥ 0,42

	modular system				modular system				Mosaico Mosaic	Battiscopa Skirting	Scretto Rabbeted riser	Gradino costa retta Straight nosed stair **			Gradino costa retta - Angolo SX / DX Straight-edge step - LH/RH corner **			Gradino Bordo Dritto Straight-edge step **			Gradino Bordo Dritto - Angolo SX / DX Straight-edge step - LH/RH corner **			
	320x160 126"x63" Nat. Ret.	160x160 63"x63" Nat. Ret.	160x80 63"x31 1/2" Nat. Ret.	80x80 31 1/2"x31 1/2" Nat. Ret.	240x120 96"x48" Nat. Ret.	120x120 48"x48" Nat. Ret.	30x30 12"x12" Nat. Ret.	8x80 3"x31 1/2" Nat. Ret.	20x160 8"x63" Nat. Ret.	20x80 8"x31 1/2" Nat. Ret.	33x160x3,2h 13"x63"x1 1/4" Nat. Ret.	33x120x3,2h 13"x48"x1 1/4" Nat. Ret.	33x80x3,2h 13"x31 1/2"x1 1/4" Nat. Ret.	33x160x3,2h 13"x63"x1 1/4" Nat. Ret.	33x120x3,2h 13"x48"x1 1/4" Nat. Ret.	33x80x3,2h 13"x31 1/2"x1 1/4" Nat. Ret.	30x160x4h 12"x63"x1 1/2" Nat. Ret.	30x120x4h 12"x48"x1 1/2" Nat. Ret.	30x80x4h 12"x31 1/2"x1 1/2" Nat. Ret.	30x160x4h 12"x63"x1 1/2" Nat. Ret.	30x120x4h 12"x48"x1 1/2" Nat. Ret.	30x80x4h 12"x31 1/2"x1 1/2" Nat. Ret.		
ANTRACITE	082010	082050	082090	082110	082030	082070	082189	082204	082220	082228	082244	082252	082260	082308 SX 082276 DX	082316 SX 082284 DX	082324 SX 082292 DX	082340	082348	082356	082404 SX 082372 DX	082412 SX 082380 DX	082420 SX 082388 DX		
FUMO	082007	082047	082087	082107	082027	082067	082185	082203	082219	082227	082207	082251	082259	082307 SX 082275 DX	082315 SX 082283 DX	082323 SX 082291 DX	082339	082347	082355	082403 SX 082371 DX	082411 SX 082379 DX	082419 SX 082387 DX		
GHIACCIO	082001	082041	082081	082101	082021	082061	082181	082201	082217	082225	082205	082249	082257	082305 SX 082273 DX	082313 SX 082281 DX	082321 SX 082289 DX	082337	082345	082353	082401 SX 082369 DX	082409 SX 082377 DX	082417 SX 082385 DX		
BEIGE	082004	082044	082084	082104	082024	082064	082183	082202	082218	082226	082206	082250	082258	082306 SX 082274 DX	082314 SX 082282 DX	082322 SX 082290 DX	082338	082346	082354	082402 SX 082370 DX	082410 SX 082378 DX	082418 SX 082386 DX		
PREZZO PRICE	€ 106,00 m ²	€ 94,00 m ²	€ 74,00 m ²	€ 62,00 m ²	€ 86,00 m ²	€ 74,00 m ²	€ 126,00 m ²	€ 7,00 PZ/PCE	€ 30,00 PZ/PCE	€ 22,00 PZ/PCE	€ 272,00 PZ/PCE	€ 176,00 PZ/PCE	€ 100,00 PZ/PCE	€ 304,00 PZ/PCE	€ 212,00 PZ/PCE	€ 136,00 PZ/PCE	€ 178,00 PZ/PCE	€ 126,00 PZ/PCE	€ 68,00 PZ/PCE	€ 240,00 PZ/PCE	€ 178,00 PZ/PCE	€ 116,00 PZ/PCE		
CODICE PREZZO PRICE CODE	M173	M161	M141	M129	M153	M141	M193	P025	P077	P061	P303	P243	P167	P319	P273	P203	P245	P193	P135	P287	P245	P183		
IMBALLO cm h. PACKING cm h.	37	193,5	40,4	193,5	40,9	-	40	153,5	64,7	153,5	-	-	40,9	-	-	-	40,9	-	-	40,9	-	-	-	
Tara / Tare	140,00	210,00	71,80	210,00	-	20	100,00	158,00	-	158,00	-	-	-	-	-	-	-	-	-	-	-	-	-	
N°	14	44	24	88	-	-	20	44	-	88	-	-	-	-	-	-	-	-	-	-	-	-	-	
m ² x	5,12	5,12	2,56	2,56	-	-	2,88	2,88	-	1,44	-	-	-	-	-	-	-	-	-	-	-	-	-	
Kg x	74,14	74,14	37,07	37,07	-	-	41,70	41,70	-	20,85	-	-	-	-	-	-	-	-	-	-	-	-	-	
x	-	-	-	-	2	3	-	-	2	-	-	12	1	1	1	2	2	1	1	1	1	2	2	1
m ² x	-	-	-	-	2,56	1,92	-	-	2,88	-	-	0,77	-	-	-	-	-	-	-	-	-	-	-	-
Kg x	-	-	-	-	37,2	27,90	-	-	41,70	-	-	11,50	5	3	9	14	10	10	7	6	8,5	13,5	9	9,5
x	-	-	-	-	15	40	-	-	24	-	-	-	-	-	-	-	-	-	-	-	-	-	-	-
m ² x	71,68	225,28	61,44	225,28	38,40	76,80	57,60	126,72	69,12	126,72	-	-	-	-	-	-	-	-	-	-	-	-	-	-
Kg x	1.178	3.472	962	3.472	648	1.141	934	1.993	1.057	1.993	-	-	-	-	-	-	-	-	-	-	-	-	-	-



Cavalletto in legno
Wood A-Frame
Support en bois
Holzgestell
Caballete de madera
Деревянная подставка



Cassa
Crate
Caisse
Kiste
Caja
Ящик



Pallet speciale con sponde
Special pallet with sides
Palette spéciale avec bords
Spezial-Palette mit Wandungen
Palet especial con bordes
Специальный поддон с боковинами

** PEZZI SPECIALI - A disposizione solo su richiesta. Tempi di consegna: 30gg.
TRIMS - Available upon request only. Delivery terms: 30 days.
PIÈCES SPECIALES - Disponible seulement sur requête. Délais de livraison: 30 jours.
FORMSTÜCKE - Verfügbar auf Anfrage. Lieferzeit: 30 Tage.
PIEZAS ESPECIALES - Disponible sólo bajo pedido. Plazo de entrega: 30 días.
СПЕЦИАЛЬНЫЕ ЭЛЕМЕНТЫ - Изготавливается только по специальной заявке. Срок поставки: 30 дней.

SKYLINE INDOOR

10 mm

ANSI A - 137.1: 2012
WET DYNAMIC COEFFICIENT OF FRICTION | DCOF ≥ 0,42

	modular system					Battiscopa Skirting			Scretto Rabbeted riser		Gradino costa retta Straight nosed stair **			Gradino costa retta - Angolo SX / DX Straight-edge step - LH/RH corner **			Gradino Bordo Dritto Straight-edge step **		Gradino Bordo Dritto - Angolo SX / DX Straight-edge step - LH/RH corner **	
																				
	100x100 40"x40" Nat. Ret.	120x60 48"x24" Nat. Ret.	120x60 48"x24" Lap. Ret.	60x60 24"x24" Nat. Ret.	60x60 24"x24" Lap. Ret.	6,5x120 2 1/2"x48" Nat. Ret.	6,5x120 2 1/2"x48" Lap. Ret.	7x100 2 3/4"x40" Nat. Ret.	20x120 8"x48" Nat. Ret.	20x120 8"x48" Lap. Ret.	33x120x3,2h 13"x48"x1 1/4" Nat. Ret.	33x120x3,2h 13"x48"x1 1/4" Lap. Ret.	33x100x3,2h 13"x40"x1 1/4" Nat. Ret.	33x120x3,2h 13"x48"x1 1/4" Nat. Ret.	33x120x3,2h 13"x48"x1 1/4" Lap. Ret.	33x100x3,2h 13"x40"x1 1/4" Nat. Ret.	30x120x4h 12"x48"x1 1/2" Nat. Ret.	30x120x4h 12"x48"x1 1/2" Lap. Ret.	30x120x4h 12"x48"x1 1/2" Nat. Ret.	30x120x4h 12"x48"x1 1/2" Lap. Ret.
ANTRACITE 	082094	082130	082131	082150	082151	082212	082436	082120	082236	082243	082268	082452	082248	082332 SX 082300 DX	082468 SX 082460 DX	082312 SX 082280 DX	082364	082476	082428 SX 082396 DX	082492 SX 082484 DX
FUMO 	082091	082127	082128	082147	082148	082211	082435	082117	082237	082242	082267	082451	082245	082331 SX 082299 DX	082467 SX 082459 DX	082309 SX 082277 DX	082363	082475	082427 SX 082395 DX	082491 SX 082483 DX
GHIACCIO 	082093	082121	082122	082141	082142	082209	082433	082119	082239	082240	082265	082449	082247	082329 SX 082297 DX	082465 SX 082457 DX	082311 SX 082279 DX	082361	082473	082425 SX 082393 DX	082489 SX 082481 DX
BEIGE 	082092	082124	082125	082144	082145	082210	082434	082118	082238	082241	082266	082450	082246	082330 SX 082298 DX	082466 SX 082458 DX	082310 SX 082278 DX	082362	082474	082426 SX 082394 DX	082490 SX 082482 DX
PREZZO PRICE	€ 46,00 m ²	€ 46,00 m ²	€ 58,00 m ²	€ 36,00 m ²	€ 48,00 m ²	€ 8,00 PZ/PCE	€ 9,00 PZ/PCE	€ 8,00 PZ/PCE	€ 26,00 PZ/PCE	€ 28,00 PZ/PCE	€ 140,00 PZ/PCE	€ 148,00 PZ/PCE	€ 140,00 PZ/PCE	€ 164,00 PZ/PCE	€ 176,00 PZ/PCE	€ 152,00 PZ/PCE	€ 106,00 PZ/PCE	€ 112,00 PZ/PCE	€ 134,00 PZ/PCE	€ 134,00 PZ/PCE
CODICE PREZZO PRICE CODE	M109	M109	M125	M089	M113	P029	P033	P029	P069	P073	P207	P215	P207	P231	P243	P219	P173	P179	P201	P201
		EPAL 80x120		EPAL 80x120		Pallet 80x120		Pallet 103x103	Pallet 80x120		Pallet 80x120		Pallet 103x103	Pallet 80x120		Pallet 103x103	Pallet 80x120		Pallet 80x120	
IMBALLO cm h. PACKING cm h.	75	-		-		-		-	-		-		-	-		-	-		-	
Tara / Tare	-	20		20		-		-	-		-		-	-		-	-		-	
 x 	2	2		3		6		6	1		2		2	1		1	2		1	
m ² x 	2	1,44		1,08		-		-	-		-		-	-		-	-		-	
Kg x 	40,75	33,41		24,80		11,4		9	12		22		14	11		9	22		11	
 x 	24	30		40		-		-	-		-		-	-		-	-		-	
m ² x 	48	43,2		43,2		-		-	-		-		-	-		-	-		-	
Kg x 	1.023	1.025		1.012		-		-	-		-		-	-		-	-		-	











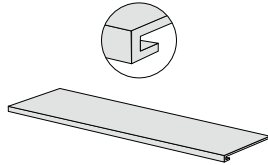
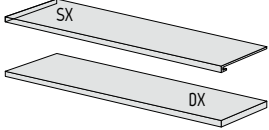





Pallet speciale con sponde
Special pallet with sides
Palette spéciale avec bords
Spezial-Palette mit Wandungen
Palet especial con bordes
Специальный поддон с боковинами

SKYLINE OUTDOOR

10 mm RII-C

ANSI A - 137.1: 2012
WET DYNAMIC COEFFICIENT OF FRICTION | DCOF ≥ 0,42

		Gradino costa retta Straight nosed stair **	Gradino costa retta - Angolo SX / DX Straight-edge step - LH/RH corner **
			
	100x100 40"x40" Nat. Ret.	33x100x3,2h 13"x40"x1 1/4"h Nat. Ret.	33x100x3,2h 13"x40"x1 1/4"h Nat. Ret.
ANTRACITE 	082098	082256	082320 SX 082288 DX
FUMO 	082095	082253	082317 SX 082285 DX
GHIACCIO 	082097	082255	082319 SX 082287 DX
BEIGE 	082096	082254	082318 SX 082286 DX
PREZZO PRICE	€ 46,00 m ²	€ 140,00 PZ/PCE	€ 152,00 PZ/PCE
CODICE PREZZO PRICE CODE	M109	P207	P219
		Pallet 103x103	Pallet 103x103
IMBALLO cm h. PACKING cm h.	75	-	-
Tara / Tare	-	-	-
 x 	2	2	1
m ² x 	2	-	-
Kg x 	40,75	14	9
 x 	24	-	-
m ² x 	48	-	-
Kg x 	1.023	-	-

**
PEZZI SPECIALI - A disposizione solo su richiesta. Tempi di consegna: 30gg.
TRIMS - Available upon request only. Delivery terms: 30 days.
PIÈCES SPECIALES - Disponible seulement sur requête. Délais de livraison: 30 jours.
FORMSTÜCKE - Verfügbar auf Anfrage. Lieferzeit: 30 Tage.
PIEZAS ESPECIALES - Disponible sólo bajo pedido. Plazo de entrega: 30 días.
СПЕЦИАЛЬНЫЕ ЭЛЕМЕНТЫ - Изготавливается только по специальной заявке. Срок поставки: 30 дней.







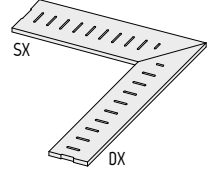
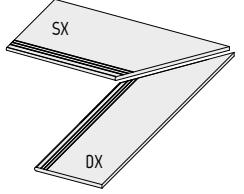
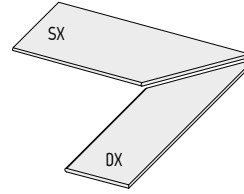

Pallet speciale con sponde
Special pallet with sides
Palette spéciale avec bords
Spezial-Palette mit Wandungen
Palet especial con bordes
Специальный поддон с боковинами

Floor
Antracite 100x100 (40"x40") Nat. Ret. 20mm RII
Griglia 20x100 (18"x40") Nat. Ret. 20mm RII
Gradone bordo 50 100x50 (40"x20") Nat. Ret. 20mm RII

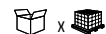

20 mm RII-C

ANSI A - 137.1: 2012
WET DYNAMIC COEFFICIENT OF FRICTION | DCOF ≥ 0,42

		Griglia 20 Drainage grid 20	Griglia 20 - Angolo SX / DX Drainage grid 20 - LH/RH corner	Gradone bordo 50 grip Large step with anti-slip border	Gradone bordo 50 grip - Angolo SX / DX Large step with anti-slip border - LH/RH corner	Gradone bordo 50 Large step 50	Gradone bordo 50 - Angolo SX / DX Large step 50 - LH/RH corner				
											
	100x100 40"x40" Nat. Ret.	20x100 8"x40" Nat. Ret.	20x100 8"x40" Nat. Ret.	50x100 20"x40" Nat. Ret.	50x100 20"x40" Nat. Ret.	50x100 20"x40" Nat. Ret.	50x100 20"x40" Nat. Ret.				
ANTRACITE		082114	082664	082700	082688	082616	082604	082708 SX 082704 DX	082696 SX 082692 DX	082624 SX 082620 DX	082612 SX 082608 DX
FUMO		082111	082661	082697	082685	082613	082601	082705 SX 082701 DX	082693 SX 082689 DX	082621 SX 082617 DX	082609 SX 082605 DX
CHIACCIO		082113	082663	082699	082687	082615	082603	082707 SX 082703 DX	082695 SX 082691 DX	082623 SX 082619 DX	082611 SX 082607 DX
BEIGE		082112	082662	082698	082686	082614	082602	082706 SX 082702 DX	082694 SX 082690 DX	082622 SX 082618 DX	082610 SX 082606 DX
PREZZO PRICE	€ 76,00 m ²	€ 248,00 PZ/PCE	€ 248,00 PZ/PCE	€ 160,00 PZ/PCE	€ 140,00 PZ/PCE	€ 136,00 PZ/PCE	€ 118,00 PZ/PCE	€ 178,00 PZ/PCE	€ 158,00 PZ/PCE	€ 154,00 PZ/PCE	€ 136,00 PZ/PCE
CODICE PREZZO PRICE CODE	M143	P291	P291	P227	P207	P203	P185	P245	P225	P221	P203
	Pallet 103x103	Pallet 103x103	Pallet 103x103	Pallet 103x103	Pallet 103x103	Pallet 103x103	Pallet 103x103	Pallet 103x103	Pallet 103x103	Pallet 103x103	Pallet 103x103
IMBALLO cm h. PACKING cm h.	73	-	-	-	-	-	-	-	-	-	-
Tara / Tare	-	-	-	-	-	-	-	-	-	-	-
 x 	1	-	-	-	-	-	-	-	-	-	-
m ² x 	1	1	1	1	1	1	1	1	1	1	1
Kg x 	39,85	-	-	-	-	-	-	-	-	-	-
 x 	24	8	8	15	15	15	15	15	15	15	15
m ² x 	24	-	-	-	-	-	-	-	-	-	-
Kg x 	982	-	-	-	-	-	-	-	-	-	-

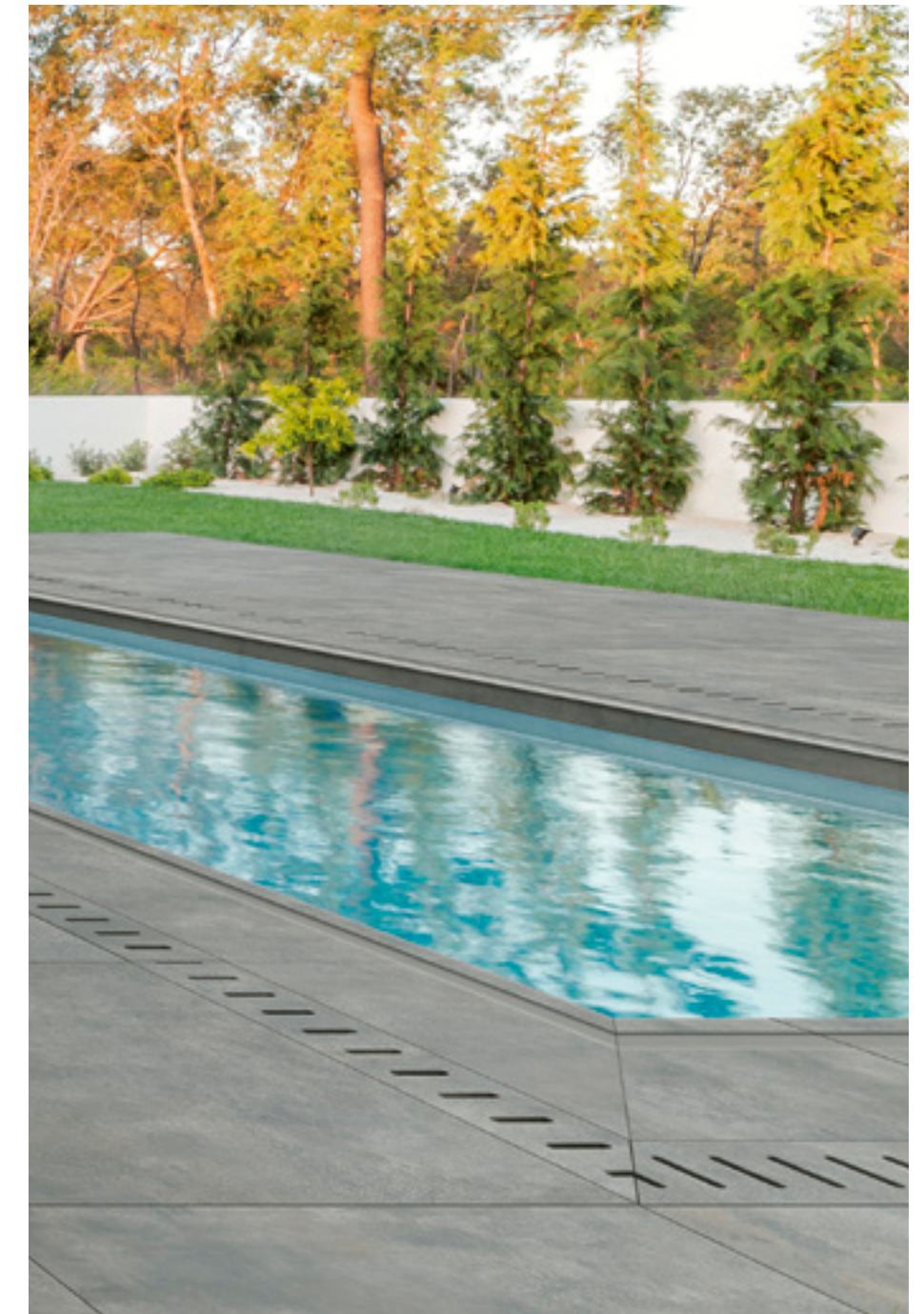

Tra i fondi di spessore 10 e 20 mm non si garantisce l'abbinabilità.
We cannot guarantee tonal matches between the same background tiles with different thickness (10 or 20 mm).
Les assortiments des tons ne sont pas garantis pour les fonds d'une épaisseur de 10 et 20 mm.
Bei Bodenfliesen mit einer Stärke von 10 und 20 mm wird keine Einheitlichkeit der Farbtöne garantiert.
Para los fondos de espesor 10 y 20 mm no se garantiza la combinabilidad de tonalidades.
Для фоновой плитки толщиной 10 и 20 мм не гарантирована цветовая сочетаемость.

Per il gradino non si garantisce la stessa tonalità del fondo.
We cannot guarantee that the shade of the stair tile will be the same as the background tile.
Pour la marche, nous ne garantissons pas la même tonalité du fond.
Für die Stufe wird nicht der gleiche Farbton der Grundfliese garantiert.
Para el peldaño no se garantiza el mismo tono del fondo.
Для ступени не гарантирована одинаковость тона с фоном.



Costa toro.
Bullnose edge.
Bord boudin.
Abgerundete Kante.
Canto redondo.
Закругленная кромка.



Costa retta.
Straight edge.
Bord droit.
Gerade Kante.
Canto recto.
Прямоугольная кромка.

ATTENZIONE: Per particolari installazioni potrebbero essere necessari articoli ed accessori specifici non presenti in questo catalogo. Per queste esigenze prego riferirsi direttamente al referente commerciale La Fabbrica.
N.B. Particular items and accessories not listed in this catalogue may be required for certain laying methods. For these needs, please contact the La Fabbrica sales directly.
ATTENTION: Pour les installations particulières, certains articles et accessoires particuliers qui ne sont pas indiqués dans ce catalogue pourraient être nécessaires. Dans ces cas-là, nous vous prions de vous référer directement à la référence commerciale La Fabbrica.
ACHTUNG: Für besondere Installationen können besondere Artikel oder Sonderzubehör notwendig sein, die nicht im vorliegenden Katalog aufgeführt sind. Wenden Sie sich bitte in diesen Fällen direkt an den Vertrieb von La Fabbrica.
ATENCIÓN: para instalaciones particulares podrían requerirse artículos y accesorios específicos que no están presentes en este catálogo. Para tales casos rogamos contactar directamente al representante comercial de La Fabbrica.
ВНИМАНИЕ: Для особых применений могут быть необходимы специальные артикулы и аксессуары, не представленные в данном каталоге. По поводу этих вопросов просим вас обращаться непосредственно к менеджеру коммерческого отдела компании La Fabbrica.



DESIGN

Design . Design . Design . Diseños . Дизайн .

INDOOR

SCRATCH..... 382

SCRATCH

Designers: Doriana and Massimiliano **FUKSAS**

MOONLIGHT

SUPERLUNA

ECLIPSE

MILKY WAY

LIGHT GRAFFITI

DARK GRAFFITI

LASTRE IN GRES PORCELLANATO PRESSATE A SECCO . DRY-PRESSED PORCELAIN STONWARE SLABS .
 DALLES EN GRÈS CÉRAME PRESSÉES À SEC . TROCKENGEPRESSTE PLATTEN AUS FEINSTEINZEUG .
 PLANCHAS EN GRÈS PORCELÁNICO PRENSADAS EN SECO . КЕРАМОГРАНИТНЫЕ ПЛИТЫ СУХОГО ПРЕССОВАНИЯ .
 UNI EN 14411-ISO 13006 - Appendice C - Gruppo BIa - UGL

100% DESIGN
AND PRODUCTION
OF ITALY

V2
SHADE SPECTRUM
MODERATE

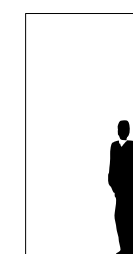

320x160 . 126"x63"
Nat. Ret.

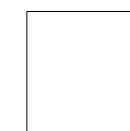

160x160 . 63"x63"
Nat. Ret.



160x80 . 63"x31 1/2"
Nat. Ret.



80x80 . 31 1/2"x31 1/2"
Nat. Ret.

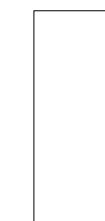

280x120 . 110"x48"
Nat. Ret.



Mosaico
30x30 . 12"x12"
Nat. Ret.

6 mm

modular system

INDOOR



120x60 . 48"x24"
Nat. Ret.

10 mm

SVILUPPO GRAFICO PER FORMATO
 Pattern by size
 Développement graphique par format
 Grafischer Entwurf für Format
 Desarrollo gráfico por formato
 Варианты графики для каждого формата

320x160
6 mm

160x160
6 mm

160x80
6 mm

80x80
6 mm

280x120
6 mm

120x60
10 mm

7

14

28

56

11

9



Wall
Light Graffiti 320x160 (126"x63") Nat. Ret.

Floor
Milky Way 160x160 (63"x63") Nat. Ret.



Wall
Supertuna 320x160 (126"x63") Nat. Ret.

Floor
Light Craffiti 160x160 (63"x63") Nat. Ret.

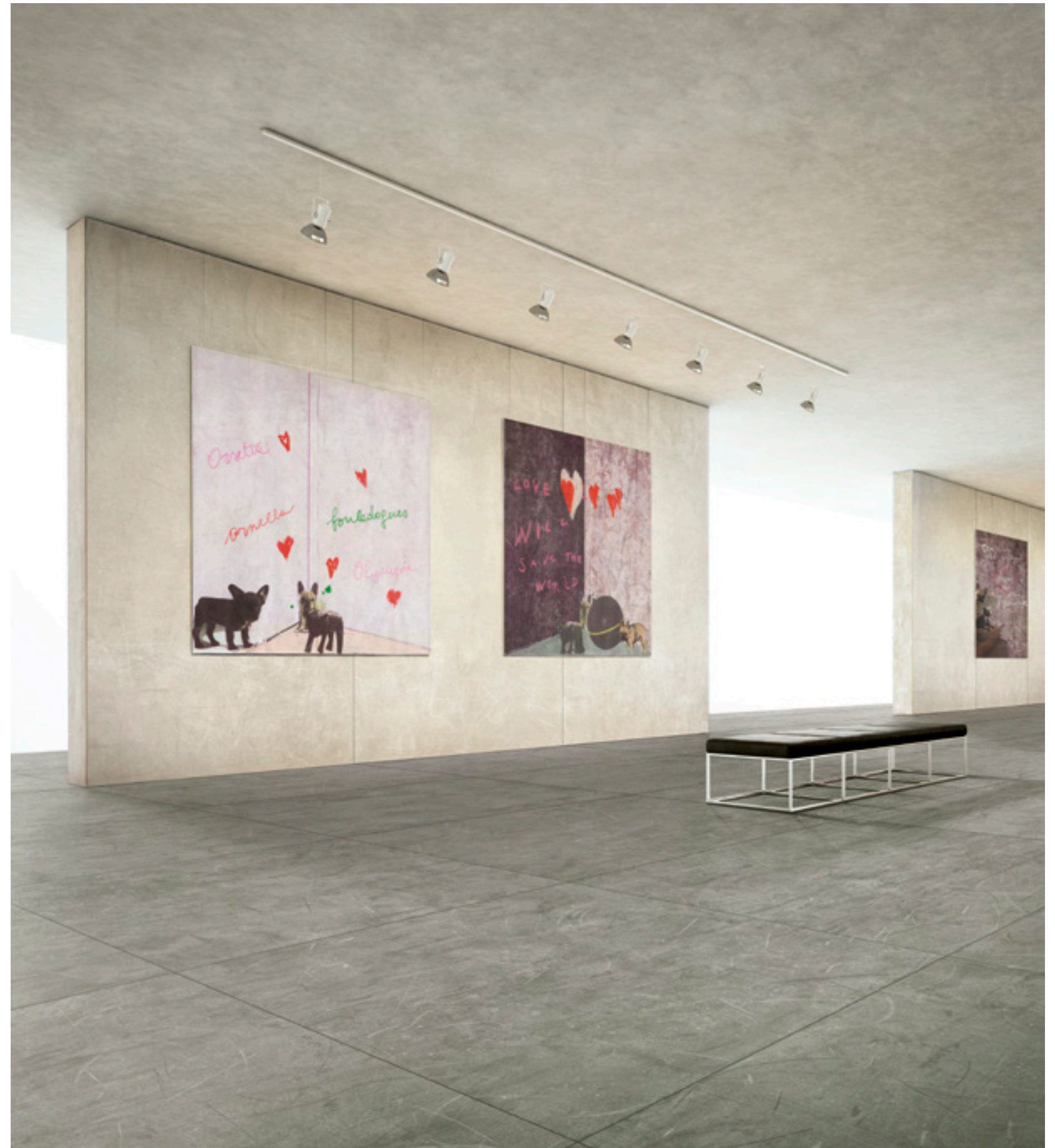

Wall >
Milky Way 320x160 (126"x63") Nat. Ret.

Floor
Eclipse 160x160 (63"x63") Nat. Ret.



320x160
 SVILUPPO GRAFICO PER FORMATO - 7 Pattern by size
 7 Développement graphique par format - 7 Grafischer Entwurf für Format
 7 Desarrollo gráfico por formato - 7 Варианты графики для каждого формата

6 mm



149004
320x160 . 126"x63"
 Nat. Ret.

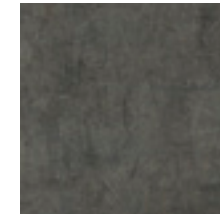

149044
160x160 . 63"x63"
 Nat. Ret.



149084
160x80 . 63"x31 1/2"
 Nat. Ret.



149104
80x80 . 31 1/2"x31 1/2"
 Nat. Ret.

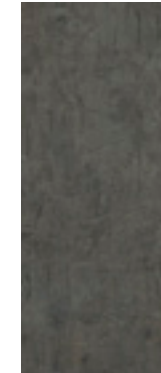

149024
280x120 . 110"x48"
 Nat. Ret.



Mosaico
149433
30x30 . 12"x12"
 Nat. Ret.

modular system

INDOOR

10 mm

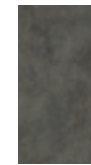

149124
120x60 . 48"x24"
 Nat. Ret.



320x160
 SVILUPPO GRAFICO PER FORMATO - 7 Pattern by size
 7 Développement graphique par format - 7 Grafischer Entwurf für Format
 7 Desarrollo gráfico por formato - 7 Варианты графики для каждого формата

6 mm



149003
320x160 . 126"x63"
 Nat. Ret.

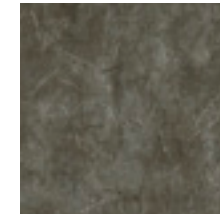

149043
160x160 . 63"x63"
 Nat. Ret.



149083
160x80 . 63"x31 1/2"
 Nat. Ret.

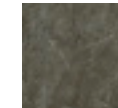

149103
80x80 . 31 1/2"x31 1/2"
 Nat. Ret.

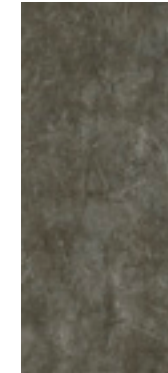

149023
280x120 . 110"x48"
 Nat. Ret.



Mosaico
149432
30x30 . 12"x12"
 Nat. Ret.

modular system

INDOOR

10 mm



149123
120x60 . 48"x24"
 Nat. Ret.



320x160
SVILUPPO GRAFICO PER FORMATO - 7 Pattern by size
 7 Développement graphique par format - 7 Grafischer Entwurf für Format
 7 Desarrollo gráfico por formato - 7 Варианты графики для каждого формата

6 mm

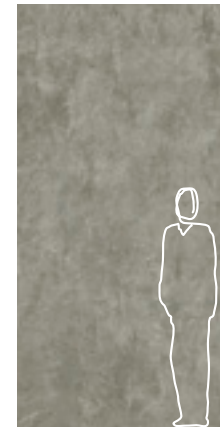

I49002
320x160 . 126"x63"
 Nat. Ret.

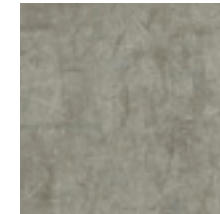

I49042
160x160 . 63"x63"
 Nat. Ret.



I49082
160x80 . 63"x31 1/2"
 Nat. Ret.



I49102
80x80 . 31 1/2"x31 1/2"
 Nat. Ret.



I49022
280x120 . 110"x48"
 Nat. Ret.



Mosaico
I49431
30x30 . 12"x12"
 Nat. Ret.

modular system

INDOOR

10 mm

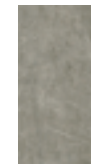

I49122
120x60 . 48"x24"
 Nat. Ret.



320x160
SVILUPPO GRAFICO PER FORMATO - 7 Pattern by size
7 Développement graphique par format - 7 Grafischer Entwurf für Format
7 Desarrollo gráfico por formato - 7 Варианты графики для каждого формата

6 mm



149001
320x160 . 126"x63"
Nat. Ret.



149041
160x160 . 63"x63"
Nat. Ret.

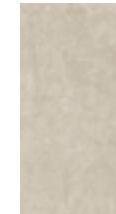

149081
160x80 . 63"x31 1/2"
Nat. Ret.



149101
80x80 . 31 1/2"x31 1/2"
Nat. Ret.

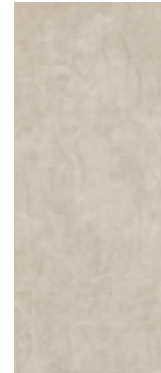

149021
280x120 . 110"x48"
Nat. Ret.



Mosaico
149430
30x30 . 12"x12"
Nat. Ret.

modular system

INDOOR

10 mm



149121
120x60 . 48"x24"
Nat. Ret.

LIGHT GRAFFITI

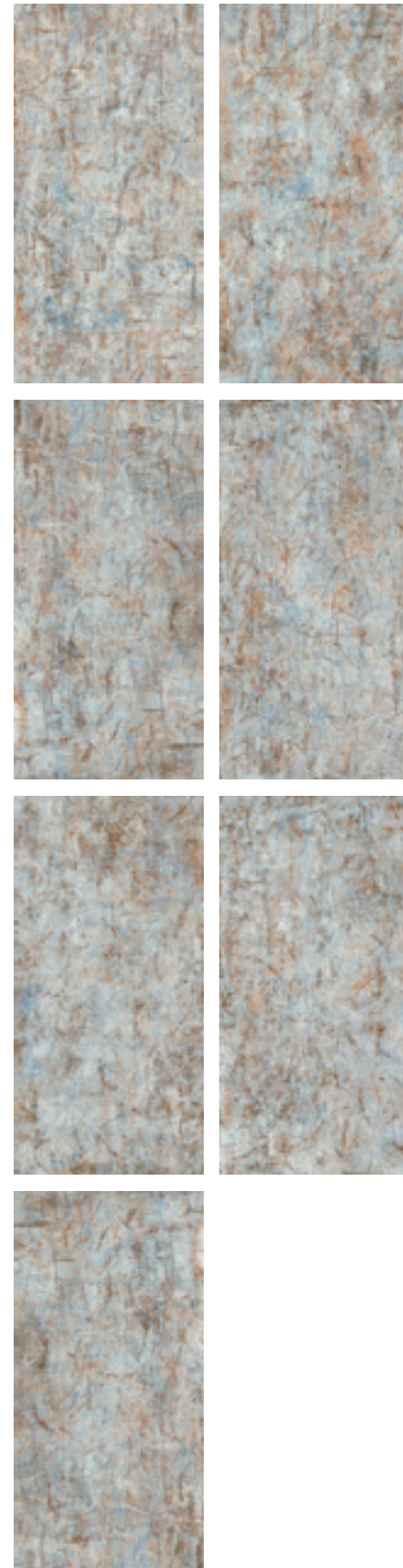

320x160
SVILUPPO GRAFICO PER FORMATO - 7 Pattern by size
7 Développement graphique par format - 7 Grafischer Entwurf für Format
7 Desarrollo gráfico por formato - 7 Варианты графики для каждого формата

6 mm



149005
320x160 . 126"x63"
Nat. Ret.



149045
160x160 . 63"x63"
Nat. Ret.



149085
160x80 . 63"x31 1/2"
Nat. Ret.



149105
80x80 . 31 1/2"x31 1/2"
Nat. Ret.



149025
280x120 . 110"x48"
Nat. Ret.



Mosaico
149434
30x30 . 12"x12"
Nat. Ret.

modular system

INDOOR

10 mm



149125
120x60 . 48"x24"
Nat. Ret.

SCRATCH

DARK GRAFFITI

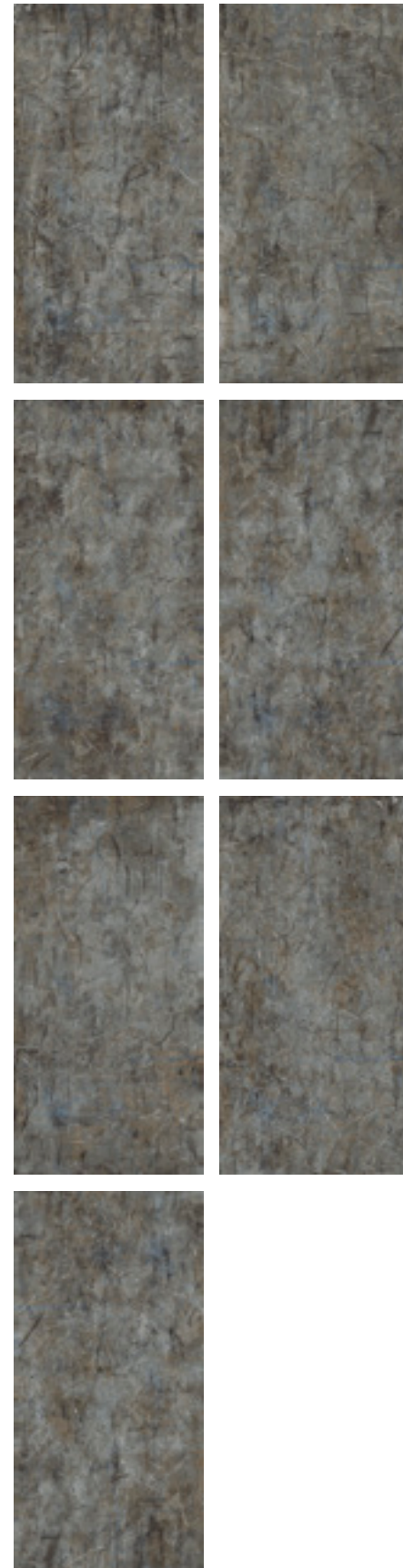
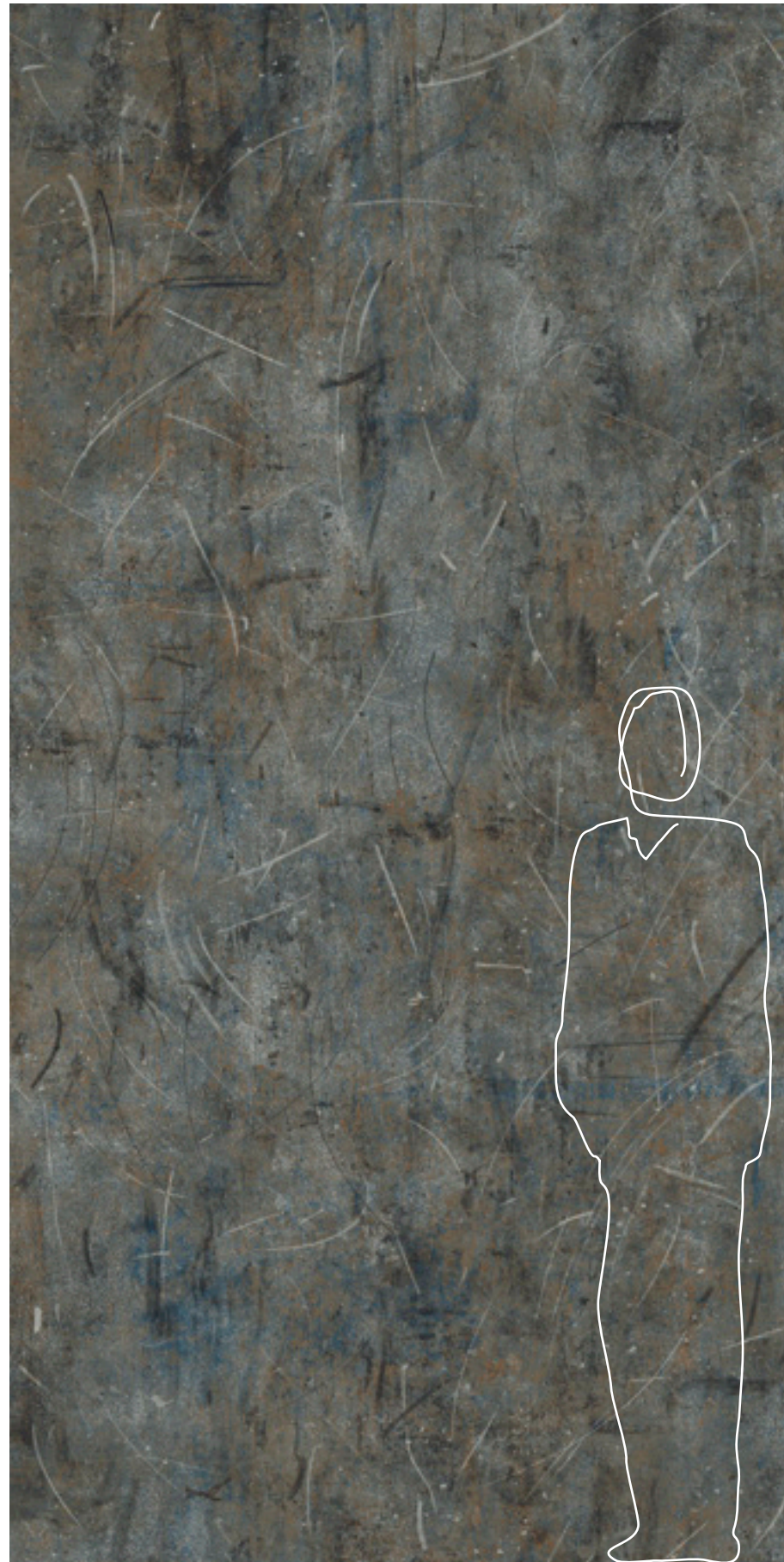

320x160
SVILUPPO GRAFICO PER FORMATO - 7 Pattern by size
7 Développement graphique par format - 7 Grafischer Entwurf für Format
7 Desarrollo gráfico por formato - 7 Варианты графики для каждого формата

6 mm



149006
320x160 . 126"x63"
Nat. Ret.

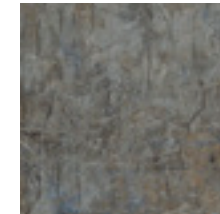

149046
160x160 . 63"x63"
Nat. Ret.



149086
160x80 . 63"x31 1/2"
Nat. Ret.



149106
80x80 . 31 1/2"x31 1/2"
Nat. Ret.



149026
280x120 . 110"x48"
Nat. Ret.



Mosaico
149435
30x30 . 12"x12"
Nat. Ret.

modular system

INDOOR

10 mm

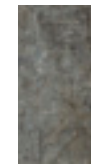

149126
120x60 . 48"x24"
Nat. Ret.

SCRATCH

6 mm

modular system

ANSI A - 137.1: 2012
WET DYNAMIC COEFFICIENT OF FRICTION | DCOF ≥ 0,42

	modular system				Mosaico Mosaic	Battiscopa Skirting	Scuretto Rabbeted riser	Gradino costa retta Straight nosed stair **	Gradino costa retta - Angolo SX / DX Straight-edge step - LH/RH corner **	Gradino Bordo Dritto Straight-edge step **	Gradino Bordo Dritto - Angolo SX / DX Straight-edge step - LH/RH corner **							
	320x160 126"x63" Nat. Ret.	160x160 63"x63" Nat. Ret.	160x80 63"x31 1/2" Nat. Ret.	80x80 31 1/2"x31 1/2" Nat. Ret.	280x120 110"x48" Nat. Ret.	30x30 12"x12" Nat. Ret.	8x80 3"x31 1/2" Nat. Ret.	20x160 8"x63" Nat. Ret.	20x80 8"x31 1/2" Nat. Ret.	33x160x3,2h 13"x63"x1 1/4" Nat. Ret.	33x80x3,2h 13"x31 1/2"x1 1/4" Nat. Ret.	33x160x3,2h 13"x63"x1 1/4" Nat. Ret.	33x80x3,2h 13"x31 1/2"x1 1/4" Nat. Ret.	30x160x4h 12"x63"x1 1/2" Nat. Ret.	30x80x4h 12"x31 1/2"x1 1/2" Nat. Ret.	30x160x4h 12"x63"x1 1/2" Nat. Ret.	30x80x4h 12"x31 1/2"x1 1/2" Nat. Ret.	
MOONLIGHT	149004	149044	149084	149104	149024	149433	149213	149223	149243	149253	149283	149273 SX 149263 DX	149303 SX 149293 DX	149343	149373	149363 SX 149353 DX	149393 SX 149383 DX	
SUPERLUNA	149003	149043	149083	149103	149023	149432	149212	149222	149242	149252	149282	149272 SX 149262 DX	149302 SX 149292 DX	149342	149372	149362 SX 149352 DX	149392 SX 149382 DX	
ECLIPSE	149002	149042	149082	149102	149022	149431	149211	149221	149241	149251	149281	149271 SX 149261 DX	149301 SX 149291 DX	149341	149371	149361 SX 149351 DX	149391 SX 149381 DX	
MILKY WAY	149001	149041	149081	149101	149021	149430	149210	149220	149240	149250	149280	149270 SX 149260 DX	149300 SX 149290 DX	149340	149370	149360 SX 149350 DX	149390 SX 149380 DX	
LIGHT GRAFFITI	149005	149045	149085	149105	149025	149434	149215	149225	149245	149255	149284	149274 SX 149264 DX	149304 SX 149294 DX	149344	149374	149364 SX 149354 DX	149394 SX 149384 DX	
DARK GRAFFITI	149006	149046	149086	149106	149026	149435	149214	149224	149244	149254	149285	149275 SX 149265 DX	149305 SX 149295 DX	149345	149375	149365 SX 149355 DX	149395 SX 149385 DX	
PREZZO PRICE	€ 114,00 m ²	€ 102,00 m ²	€ 88,00 m ²	€ 66,00 m ²	€ 96,00 m ²	€ 126,00 m ²	€ 7,00 PZ/PCE	€ 30,00 PZ/PCE	€ 22,00 PZ/PCE	€ 272,00 PZ/PCE	€ 100,00 PZ/PCE	€ 304,00 PZ/PCE	€ 136,00 PZ/PCE	€ 178,00 PZ/PCE	€ 68,00 PZ/PCE	€ 240,00 PZ/PCE	€ 116,00 PZ/PCE	
CODICE PREZZO PRICE CODE	M181	M169	M155	M133	M163	M193	P025	P077	P061	P303	P167	P319	P203	P245	P135	P287	P183	
IMBALLO cm h. PACKING cm h.	37	193,5	40,4	193,5	40,9	-	33,8	193,5	-	-	40,9	-	-	40,9	-	-	40,9	-
Tara / Tare	140,00	210,00	71,80	210,00	-	20	108,00	210,00	-	-	-	-	-	-	-	-	-	-
N°	14	44	24	88	-	-	20	44	-	-	-	-	-	-	-	-	-	-
m ² x	5,12	5,12	2,56	2,56	-	-	3,36	3,36	-	-	-	-	-	-	-	-	-	-
Kg x	74,14	74,14	37,07	37,07	-	-	48,65	48,65	-	-	-	-	-	-	-	-	-	-
m ² x	-	-	-	-	2	3	-	-	-	12	1	1	1	2	1	1	1	1
Kg x	-	-	-	-	2,56	1,92	-	-	-	0,77	-	-	-	-	-	-	-	-
Kg x	-	-	-	-	37,2	27,90	-	-	-	11,50	5	3	9	10	10	6	8,5	9
m ² x	71,68	225,28	61,44	225,28	38,40	76,80	67,2	147,84	-	-	-	-	-	-	-	-	-	-
Kg x	1.178	3.472	962	3.472	648	1.141	1.081	2.350	-	-	-	-	-	-	-	-	-	-



Cavalletto in legno
Wood A-Frame
Support en bois
Holzgestell
Caballete de madera
Деревянная подставка



Cassa
Crate
Caisse
Kiste
Caja
Ящик











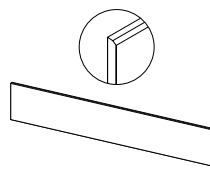
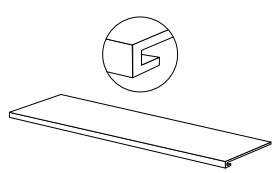
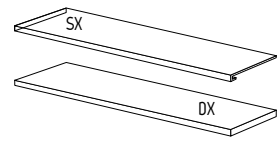
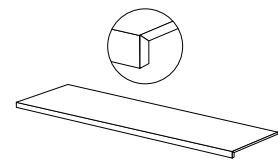
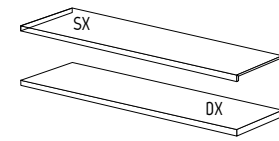
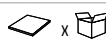

Pallet speciale con sponde
Special pallet with sides
Palette spéciale avec bords
Spezial-Palette mit Wandungen
Palet especial con bordes
Специальный поддон с боковинами

** PEZZI SPECIALI - A disposizione solo su richiesta. Tempi di consegna: 30gg.
TRIMS - Available upon request only. Delivery terms: 30 days.
PIÈCES SPECIALES - Disponible seulement sur requête. Délais de livraison: 30 jours.
FORMSTÜCKE - Verfügbar auf Anfrage. Lieferzeit: 30 Tage.
PIEZAS ESPECIALES - Disponible sólo bajo pedido. Plazo de entrega: 30 días.
СПЕЦИАЛЬНЫЕ ЭЛЕМЕНТЫ - Изготавливается только по специальной заявке. Срок поставки: 30 дней.

SCRATCH INDOOR

10 mm

ANSI A - 137.1: 2012
WET DYNAMIC COEFFICIENT OF FRICTION | DCOF ≥ 0,42

		Battiscopa Skirting	Scuretto Rabbeted riser	Gradino costa retta Straight nosed stair **	Gradino costa retta - Angolo SX / DX Straight-edge step - LH/RH corner **	Gradino Bordo Dritto Straight-edge step **	Gradino Bordo Dritto - Angolo SX / DX Straight-edge step - LH/RH corner **
	 120x60 48"x24" Nat. Ret.	 6,5x120 2 1/2"x48" Nat. Ret.	 20x120 8"x48" Nat. Ret.	 33x120x3,2h 13"x48"x1 1/4" Nat. Ret.	 33x120x3,2h 13"x48"x1 1/4" Nat. Ret.	 30x120x4h 12"x48"x1 1/2" Nat. Ret.	 30x120x4h 12"x48"x1 1/2" Nat. Ret.
MOONLIGHT	149124	149204	149233	149313	149333 SX 149323 DX	149403	149423 SX 149413 DX
SUPERLUNA	149123	149203	149232	149312	149332 SX 149322 DX	149402	149422 SX 149412 DX
ECLIPSE	149122	149202	149231	149311	149331 SX 149321 DX	149401	149421 SX 149411 DX
MILKY WAY	149121	149201	149230	149310	149330 SX 149320 DX	149400	149420 SX 149410 DX
LIGHT GRAFFITI	149125	149205	149234	149314	149334 SX 149324 DX	149405	149424 SX 149414 DX
DARK GRAFFITI	149126	149206	149235	149315	149335 SX 149325 DX	149404	149425 SX 149415 DX
PREZZO PRICE	€ 54,00 m ²	€ 8,00 PZ/PCE	€ 26,00 PZ/PCE	€ 140,00 PZ/PCE	€ 164,00 PZ/PCE	€ 106,00 PZ/PCE	€ 134,00 PZ/PCE
CODICE PREZZO PRICE CODE	M121	P029	P069	P207	P231	P173	P201
IMBALLO cm h. PACKING cm h.	EPAL 80x120	Pallet 80x120	Pallet 80x120	Pallet 80x120	Pallet 80x120	Pallet 80x120	Pallet 80x120
Tara / Tare	20	-	-	-	-	-	-
 x 	2	6	1	2	1	2	1
m ² x 	1,44	-	-	-	-	-	-
Kg x 	33,41	11,4	12	22	11	22	11
 x 	30	-	-	-	-	-	-
m ² x 	43,2	-	-	-	-	-	-
Kg x 	1.025	-	-	-	-	-	-

** PEZZI SPECIALI - A disposizione solo su richiesta. Tempi di consegna: 30gg.

TRIMS - Available upon request only. Delivery terms: 30 days.

PIÈCES SPECIALES - Disponible seulement sur requête. Délais de livraison: 30 jours.

FORMSTÜCKE - Verfügbar auf Anfrage. Lieferzeit: 30 Tage.

PIEZAS ESPECIALES - Disponible sólo bajo pedido. Plazo de entrega: 30 días.

СПЕЦИАЛЬНЫЕ ЭЛЕМЕНТЫ - Изготавливается только по специальной заявке. Срок поставки: 30 дней.



AVA STORE

Designer:

Doriana and Massimiliano **FUKSAS**

LAVABO 406
 Washbasin
 Vasque
 Waschbecken
 Fregadero
 Умывальник

LAVABO RETTANGOLARE 406
 Rectangular washbasin
 Vasque rectangulaire
 Rechteckiger Waschbecken
 Fregadero rectangular
 Прямоугольный умывальник

LAVABO DOPPIO 407
 Double washbasin
 Vasque double
 Doppelwaschbecken
 Fregadero doble
 Двойной умывальник

TOP CUCINA 408
 Kitchen top
 Plan de travail cuisine
 Arbeitsplatte der Küche
 Encimera cocina
 Кухонная столешница

TAVOLO 410
 Table
 Table
 Tisch
 Mesa
 Стол

TAVOLO OVALE 411
 Oval-shaped table
 Table de forme ovale
 Ovaler Tisch
 Mesa ovalada
 Овальный стол

LAVABO 412
 Washbasin
 Vasque
 Waschbecken
 Fregadero
 Умывальник

LAVABO DOPPIO 413
 Double washbasin
 Vasque double
 Doppelwaschbecken
 Fregadero doble
 Двойной умывальник

PIATTO DOCCIA CON RIVESTIMENTO 414
 Shower base with wall tile
 Receveur de douche avec revêtement
 Duschwanne mit Wandbelag
 Plato ducha con paredes
 Душевой поддон и облицовки стен

EXTRAORDINARYSIZE comprende una selezione di mobili per i vostri ambienti.
 Modelli dal design raffinato totalmente personalizzabili per tipo di superficie e dimensione.
 Il programma EXTRAORDINARYSIZE di AVA è uno strumento completo ricco di soluzioni innovative, un riferimento di stile per l'architettura e per l'arredo contemporaneo.

EXTRAORDINARYSIZE includes a range of furniture for your projects.
 Elegantly designed and fully customisable in terms of material type and size.
 AVA EXTRAORDINARYSIZE is a comprehensive range offering a wealth of innovative solutions ... a stylish go-to for contemporary architecture and interior design.

EXTRAORDINARYSIZE comprend une sélection de meubles pour vos espaces.
 Des modèles au design raffiné entièrement personnalisables suivant le type de surface et de dimension.
 Le programme EXTRAORDINARYSIZE d'AVA est un instrument complet riche en solutions innovantes, une référence de style pour l'architecture et la décoration contemporaines.

EXTRAORDINARYSIZE umfasst eine Auswahl von Möbeln für eure Räume.
 Es handelt sich um Modelle mit raffiniertem Design, die vollständig hinsichtlich der Art der Oberfläche und der Größe angepasst werden können.
 Das Programm EXTRAORDINARYSIZE von AVA ist ein komplettes und an innovativen Lösungen reiches Hilfsmittel, ein Bezugspunkt des Stils für die Architektur und die moderne Einrichtung.

EXTRAORDINARYSIZE comprende una selección de muebles para vuestros ambientes.
 Modelos de diseño refinado, totalmente personalizables según tipo de superficie y dimensiones.
 El programa EXTRAORDINARYSIZE de AVA es un instrumento completo, rico en soluciones innovadoras, una referencia de estilo para la arquitectura y para el mobiliario contemporáneo.

EXTRAORDINARYSIZE также предлагает подборку мебели для ваших интерьеров.
 Модели с изысканным дизайном, тип поверхности и размер которых можно выбрать в полной свободе.
 Программа EXTRAORDINARYSIZE от AVA - это самостоятельное средство с инновационными решениями, важная веха в стиле для современной архитектуры и оформления.

Designer: Doriana and Massimiliano FUKSAS

LAVABO*

WASHBASIN . VASQUE . WASCHECKEN
FREGADERO . УМЫВАЛЬНИК

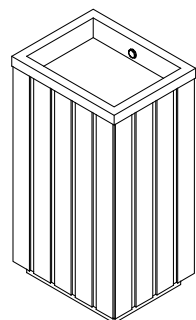
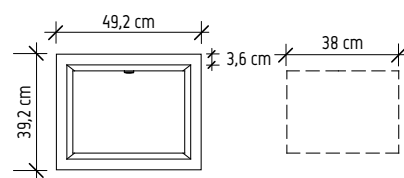
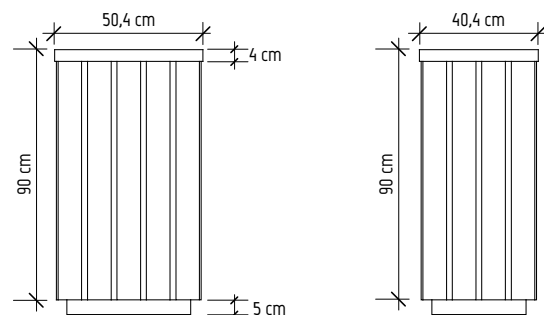

Designer: Doriana and Massimiliano FUKSAS

LAVABO RETTANGOLARE*

RECTANGULAR WASHBASIN . VASQUE RECTANGULAIRE . RECHTECKIGER WASCHECKEN
FREGADERO RECTANGULAR . ПРЯМОУГОЛЬНЫЙ УМЫВАЛЬНИК

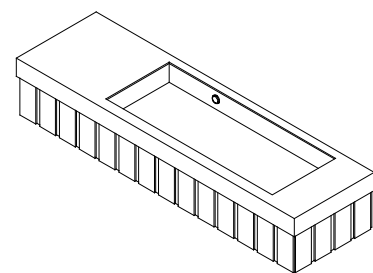
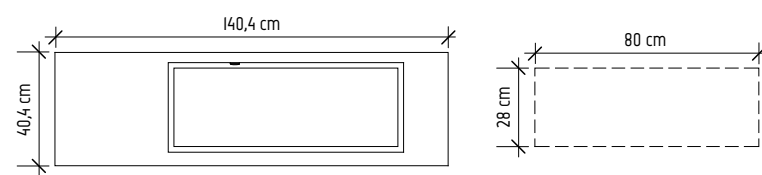
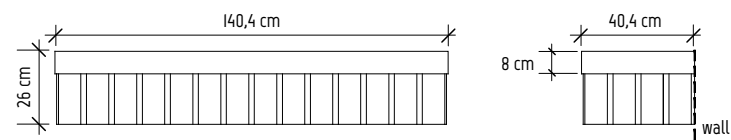

Designer: Doriana and Massimiliano FUKSAS

LAVABO DOPPIO*

DOUBLE WASHBASIN . VASQUE DOUBLE . DOPPELWASCHECKEN
FREGADERO DOBLE . ДВОЙНОЙ УМЫВАЛЬНИК

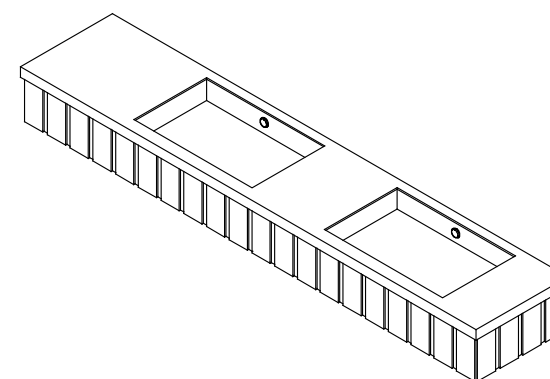
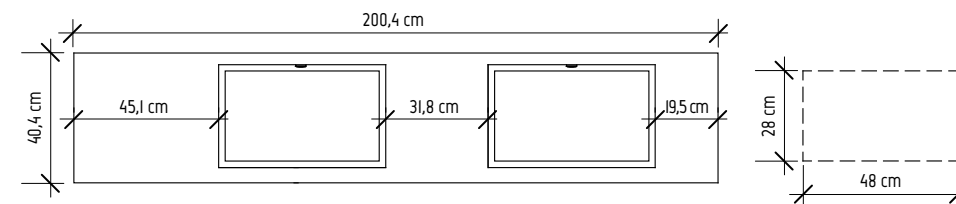
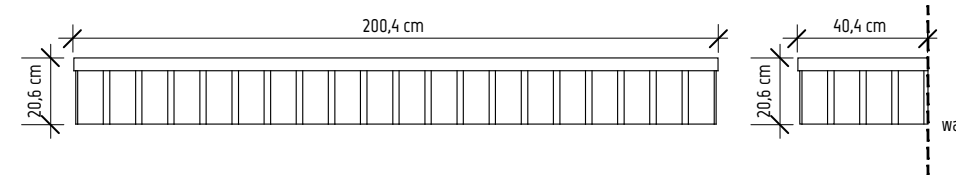

Colori disponibili
Colours available . Couleurs disponibles . Erhältliche Farben
Colores disponibles . Имеющиеся цвета



* Le dimensioni originali sono personalizzabili.
Original sizes can be altered for customisation.
Les dimensions originales sont personnalisables.
Die Original-Abmessungen können angepasst werden.
Las dimensiones originales son personalizables.
Размеры могут быть приведены в соответствие с индивидуальными необходимостями.

Per approfondire i dettagli tecnici consultare la scheda prodotto fornita da AVA

For further technical details, please see the product specifications sheet provided by AVA.

Pour approfondir les détails techniques, consulter la fiche produit fournie par AVA.

Zur Vertiefung der technischen Details lesen Sie bitten auf dem von AVA bereitgestellten Produkt-Datenblatt nach.

Para profundizar en los detalles técnicos sírvase consultar la ficha del producto proporcionada por AVA.

Для более подробного изучения технических свойств смотрите технические характеристики, предоставленные компанией AVA.

TOP CUCINA*

KITCHEN TOP . PLAN DE TRAVAIL CUISINE . ARBEITSPLATTE DER KÜCHE
ENCIMERA COCINA . КУХОННАЯ СТОЛЭШНИЦА

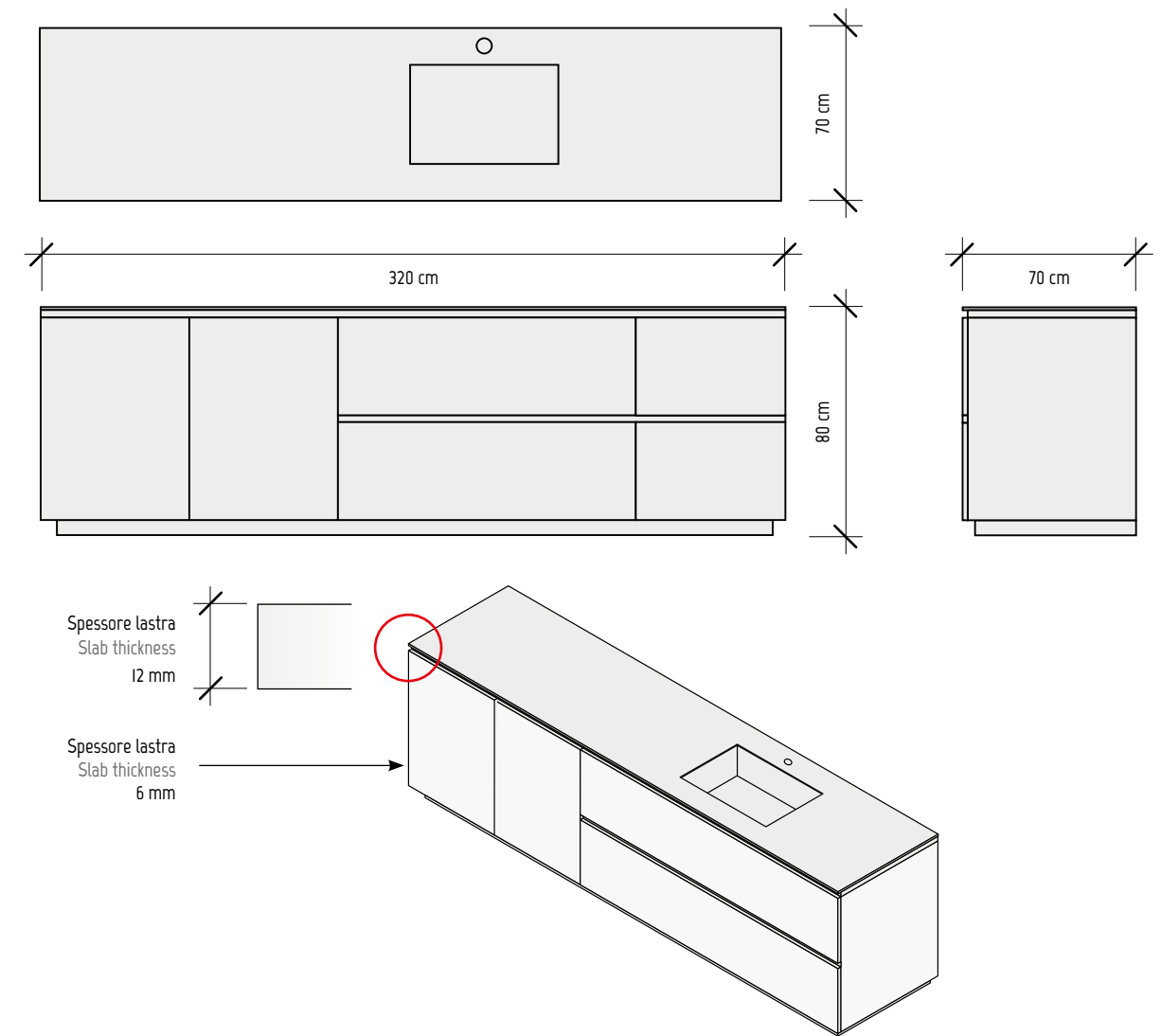

Colori disponibili . Colours available . Couleurs disponibles . Erhältliche Farben . Colores disponibles . Имеющиеся цвета

6 mm 12 mm CONTEMPORANEI ABSOLUTE WHITE	6 mm 12 mm CONTEMPORANEI ABSOLUTE BLACK	12 mm CONTEMPORANEI CITY MADRID	12 mm CONTEMPORANEI CITY LONDON	12 mm CONTEMPORANEI CITY OSLO	6 mm CONTEMPORANEI DISTRICT BIANCO	6 mm CONTEMPORANEI DISTRICT GRIGIO	6 mm CONTEMPORANEI DISTRICT NERO	6 mm CONTEMPORANEI DISTRICT TORTORA	6 mm MARM AZUL MACAUBA	12 mm 6 mm MARM BARDIGLIO CENERE	6 mm MARM BRONZE AMANI	12 mm 6 mm MARM CALACATTA	6 mm MARM CREMA MARFIL	6 mm MARM LASA	6 mm MARM NERO BELVEDERE	6 mm MARM STATUARIO	12 mm 6 mm MARM STATUARIO SPENDENTE	
6 mm CONTEMPORANEI METAL PEARL	6 mm CONTEMPORANEI METAL GREIGE	6 mm CONTEMPORANEI METAL CORTEN	6 mm CONTEMPORANEI METAL BLADE	6 mm CONTEMPORANEI SKYLINE GHIACCIO	6 mm CONTEMPORANEI SKYLINE BEIGE	6 mm CONTEMPORANEI SKYLINE FUMO	6 mm CONTEMPORANEI SKYLINE ANTRACITE	6 mm MARM TAJ MAHAL	6 mm MARM TRAVERTINO CLASSIC	6 mm MARM WHITE MACAUBA	6 mm ONICI AESTHETICA WLODE	6 mm ONICI AESTHETICA HEGEL	6 mm ONICI KANT	6 mm ONICI ONICE SERPENTINO	6 mm PIETRE E GRANITI ARDESIA	6 mm PIETRE E GRANITI C-STONE		
6 mm DESIGN MILKY WAY	6 mm DESIGN ECLIPSE	6 mm DESIGN SUPERLUNA	6 mm DESIGN MOONLIGHT	6 mm DESIGN LIGHT GRAFFITI	6 mm DESIGN DARK GRAFFITI			6 mm PIETRE E GRANITI COPACABANA PRINCESS	6 mm PIETRE E GRANITI COPACABANA DUKE	6 mm PIETRE E GRANITI COPACABANA EMPEROR	6 mm PIETRE E GRANITI PIRENEI	6 mm PIETRE E GRANITI TORTOISE	6 mm PREZIOSI NAUTILUS	6 mm PREZIOSI ONICE SMERALDO	6 mm PREZIOSI PORTORO			

* Le dimensioni originali sono personalizzabili.
Original sizes can be altered for customisation.
Les dimensions originales sont personnalisables.
Die Original-Abmessungen können angepasst werden.
Las dimensiones originales son personalizables.
Размеры могут быть приведены в соответствие с индивидуальными потребностями.

Per approfondire i dettagli tecnici consultare la scheda prodotto fornita da AVA
For further technical details, please see the product specifications sheet provided by AVA.
Pour approfondir les détails techniques, consulter la fiche produit fournie par AVA.
Zur Vertiefung der technischen Details lesen Sie bitten auf dem von AVA bereitgestellten Produkt-Datenblatt nach.
Para profundizar en los detalles técnicos sírvase consultar la ficha del producto proporcionada por AVA.
Для более подробного изучения технических свойств смотрите технические характеристики, предоставленные компанией AVA.

TAVOLO*

TABLE . TABLE . TISCH
MESA . СТОЛ

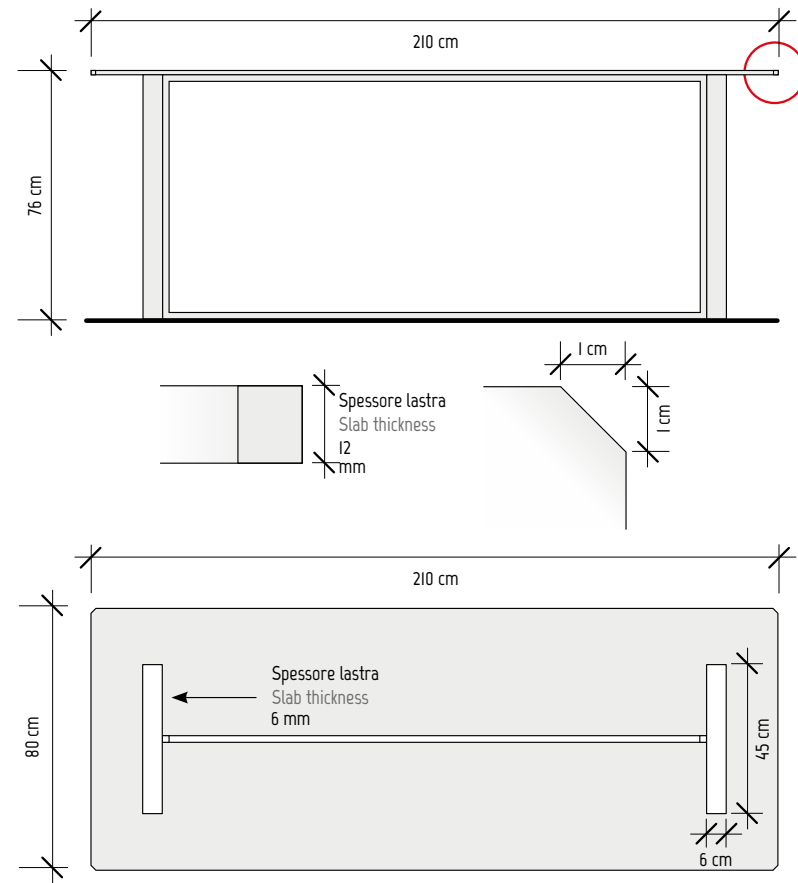

TAVOLO OVALE*

OVAL-SHAPED TABLE . TABLE DE FORME OVALE . OVALER TISCH
MESA OVALADA . ОВАЛЬНЫЙ СТОЛ

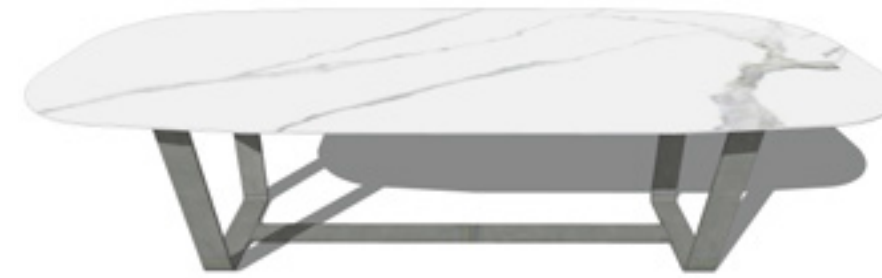

Colori disponibili . Colours available . Couleurs disponibles . Erhältliche Farben . Colores disponibles . Имеющиеся цвета

6 mm 12 mm CONTEMPORANEI ABSOLUTE WHITE	6 mm 12 mm CONTEMPORANEI ABSOLUTE BLACK	12 mm CONTEMPORANEI CITY MADRID	12 mm CONTEMPORANEI CITY LONDON	12 mm CONTEMPORANEI CITY OSLO	6 mm CONTEMPORANEI DISTRICT BIANCO	6 mm CONTEMPORANEI DISTRICT GRIGIO	6 mm CONTEMPORANEI DISTRICT NERO	6 mm CONTEMPORANEI DISTRICT TORTORA	6 mm MARM AZUL MACAUBA	12 mm 6 mm MARM BARDIGLIO CENERE	6 mm MARM BRONZE AMANI	12 mm 6 mm MARM CALACATTA	6 mm MARM CREMA MARFIL	6 mm MARM LASA	6 mm MARM NERO BELVEDERE	6 mm MARM STATUARIO	12 mm 6 mm MARM STATUARIO SPENDENTE
6 mm CONTEMPORANEI METAL PEARL	6 mm CONTEMPORANEI METAL GREIGE	6 mm CONTEMPORANEI METAL CORTEN	6 mm CONTEMPORANEI METAL BLADE	6 mm CONTEMPORANEI SKYLINE GHIACCIO	6 mm CONTEMPORANEI SKYLINE BEIGE	6 mm CONTEMPORANEI SKYLINE FUMO	6 mm CONTEMPORANEI SKYLINE ANTRACITE	6 mm MARM TAJ MAHAL	6 mm MARM TRAVERTINO CLASSIC	6 mm MARM WHITE MACAUBA	6 mm ONICI AESTHETICA WILDE	6 mm ONICI AESTHETICA HEGEL	6 mm ONICI KANT	6 mm ONICI ONICE SERPENTINO	6 mm PIETRE E GRANITI ARDESIA	6 mm PIETRE E GRANITI C-STONE	
6 mm DESIGN MILKY WAY	6 mm DESIGN ECLIPSE	6 mm DESIGN SUPERLUNA	6 mm DESIGN MOONLIGHT	6 mm DESIGN LIGHT GRAFFITI	6 mm DESIGN DARK GRAFFITI	6 mm PIETRE E GRANITI COPACABANA PRINCESS	6 mm PIETRE E GRANITI COPACABANA DUKE	6 mm PIETRE E GRANITI COPACABANA EMPEROR	6 mm PIETRE E GRANITI PIRENEI	6 mm PIETRE E GRANITI TORTOISE	6 mm PREZIOSI NAUTILUS	6 mm PREZIOSI ONICE SMERALDO	6 mm PREZIOSI PORTORO				

* Le dimensioni originali sono personalizzabili.
Original sizes can be altered for customisation.
Les dimensions originales sont personnalisables.
Die Original-Abmessungen können angepasst werden.
Las dimensiones originales son personalizables.
Размеры могут быть приведены в соответствие с индивидуальными потребностями.

Per approfondire i dettagli tecnici consultare la scheda prodotto fornita da AVA
For further technical details, please see the product specifications sheet provided by AVA.
Pour approfondir les détails techniques, consulter la fiche produit fournie par AVA.
Zur Vertiefung der technischen Details lesen Sie bitten auf dem von AVA bereitgestellten Produkt-Datenblatt nach.
Para profundizar en los detalles técnicos sírvase consultar la ficha del producto proporcionada por AVA.
Для более подробного изучения технических свойств смотрите технические характеристики, предоставленные компанией AVA.

LAVABO*

WASHBASIN . VASQUE . WASCHBECKEN
FREGADERO . УМЫВАЛЬНИК

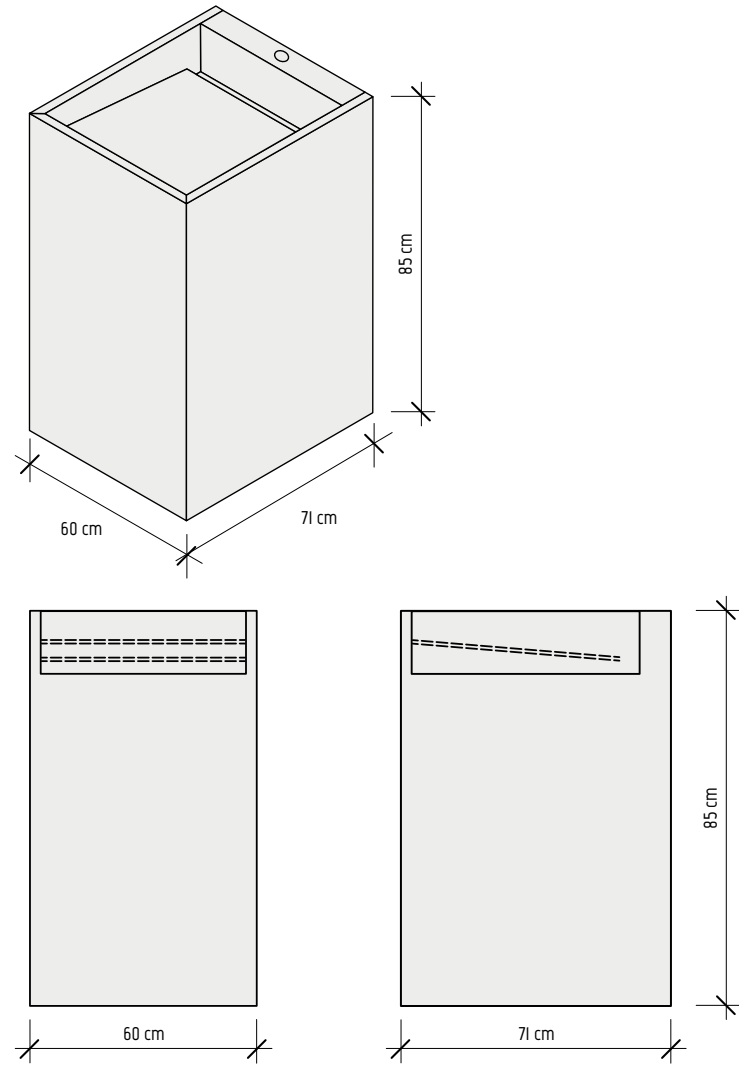

LAVABO DOPPIO*

DOUBLE WASHBASIN . VASQUE DOUBLE . DOPPELWASCHBECKEN
FREGADERO DOBLE . ДВОЙНОЙ УМЫВАЛЬНИК

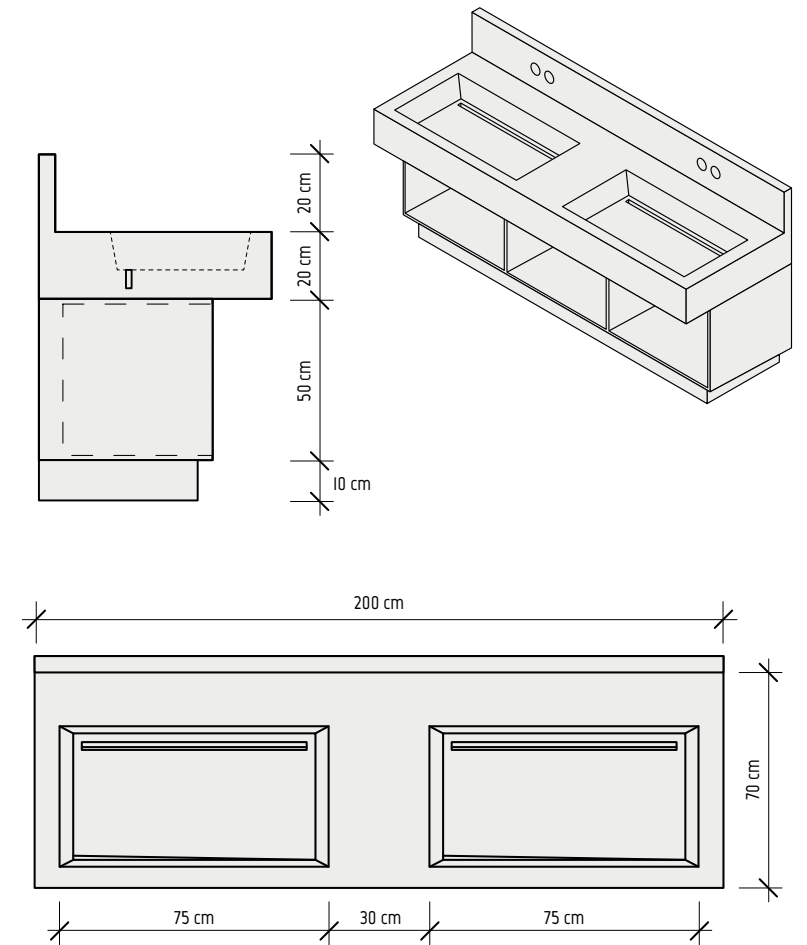

Colori disponibili . Colours available . Couleurs disponibles . Erhältliche Farben . Colores disponibles . Имеющиеся цвета

6 mm CONTEMPORANEI ABSOLUTE WHITE	6 mm CONTEMPORANEI ABSOLUTE BLACK	6 mm CONTEMPORANEI DISTRICT BIANCO	6 mm CONTEMPORANEI DISTRICT GRIGIO	6 mm CONTEMPORANEI DISTRICT NERO	6 mm CONTEMPORANEI DISTRICT TORTORA	6 mm MARM AZUL MACAUBA	6 mm MARM BARDIGLIO CENERE	6 mm MARM BRONZE AMANI	12 mm 6 mm MARM CALACATTA	6 mm MARM CREMA MARFIL	6 mm MARM LASA	6 mm MARM NERO BELVEDERE	6 mm MARM STATUARIO	6 mm MARM STATUARIO SPENDENTE		
6 mm CONTEMPORANEI METAL PEARL	6 mm CONTEMPORANEI METAL GREIGE	6 mm CONTEMPORANEI METAL CORTEN	6 mm CONTEMPORANEI METAL BLADE	6 mm CONTEMPORANEI SKYLINE GHIACCIO	6 mm CONTEMPORANEI SKYLINE BEIGE	6 mm CONTEMPORANEI SKYLINE FUMO	6 mm CONTEMPORANEI SKYLINE ANTRACITE	6 mm MARM TAJ MAHAL	6 mm MARM TRAVERTINO CLASSIC	6 mm MARM WHITE MACAUBA	6 mm ONICI AESTHETICA WILDE	6 mm ONICI AESTHETICA HEGEL	6 mm ONICI KANT	6 mm ONICI ONICE SERPENTINO	6 mm PIETRE E GRANITI ARDESIA	6 mm PIETRE E GRANITI C-STONE
6 mm DESIGN MILKY WAY	6 mm DESIGN ECLIPSE	6 mm DESIGN SUPERLUNA	6 mm DESIGN MOONLIGHT	6 mm DESIGN LIGHT GRAFFITI	6 mm DESIGN DARK GRAFFITI	6 mm PIETRE E GRANITI COPACABANA PRINCESS	6 mm PIETRE E GRANITI COPACABANA DUKE	6 mm PIETRE E GRANITI COPACABANA EMPEROR	6 mm PIETRE E GRANITI PIRENEI	6 mm PIETRE E GRANITI TORTOISE	6 mm PREZIOSI NAUTILUS	6 mm PREZIOSI ONICE SMERALDO	6 mm PREZIOSI PORTORO			

* Le dimensioni originali sono personalizzabili.
Original sizes can be altered for customisation.
Les dimensions originales sont personnalisables.
Die Original-Abmessungen können angepasst werden.
Las dimensiones originales son personalizables.
Размеры могут быть приведены в соответствие с индивидуальными необходимостями.

Per approfondire i dettagli tecnici consultare la scheda prodotto fornita da AVA
For further technical details, please see the product specifications sheet provided by AVA.
Pour approfondir les détails techniques, consulter la fiche produit fournie par AVA.
Zur Vertiefung der technischen Details lesen Sie bitten auf dem von AVA bereitgestellten Produkt-Datenblatt nach.
Para profundizar en los detalles técnicos sírvase consultar la ficha del producto proporcionada por AVA.
Для более подробного изучения технических свойств смотрите технические характеристики, предоставленные компанией AVA.

PIATTO DOCCIA CON RIVESTIMENTO

SHOWER BASE WITH WALL TILE . RECEVEUR DE DOUCHE AVEC REVÊTEMENT . DUSCHWANNE MIT WANDBELAG
 PLATO DUCHA CON PAREDES . ДУШЕВОЙ ПОДДОН И ОБЛИЦОВКИ СТЕН

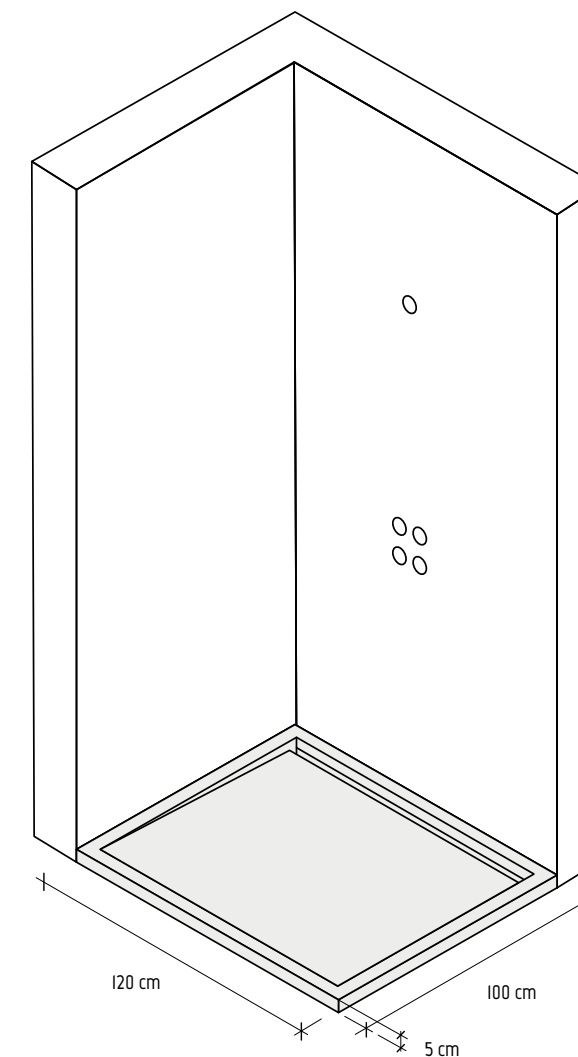
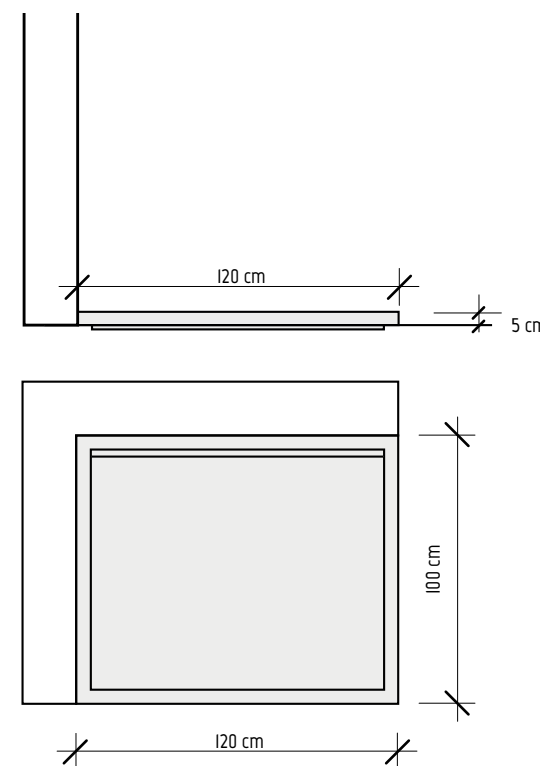

*
 Lastra
 Slab
 Dalle
 Platte
 Losa
 Плита

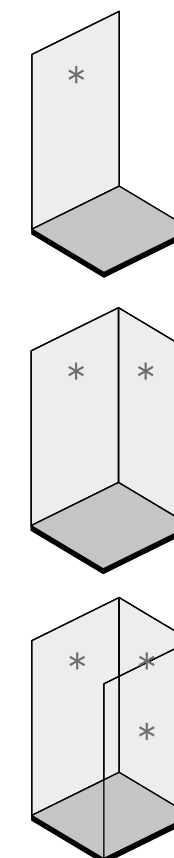

Colori disponibili . Colours available . Couleurs disponibles . Erhältliche Farben . Colores disponibles . Имеющиеся цвета

6 mm CONTEMPORANEI ABSOLUTE WHITE	6 mm CONTEMPORANEI ABSOLUTE BLACK	6 mm CONTEMPORANEI DISTRICT BIANCO	6 mm CONTEMPORANEI DISTRICT GRIGIO	6 mm CONTEMPORANEI DISTRICT NERO	6 mm CONTEMPORANEI DISTRICT TORTORA	6 mm MARM AZUL MACAUBA	6 mm MARM BARDIGLIO CENERE	6 mm MARM BRONZE AMANI	12 mm 6 mm MARM CALACATTA	6 mm MARM CREMA MARFIL	6 mm MARM LASA	6 mm MARM NERO BELVEDERE	6 mm MARM STATUARIO	6 mm MARM STATUARIO SPENDENTE		
6 mm CONTEMPORANEI METAL PEARL	6 mm CONTEMPORANEI METAL GREIGE	6 mm CONTEMPORANEI METAL CORTEN	6 mm CONTEMPORANEI METAL BLADE	6 mm CONTEMPORANEI SKYLINE GHIACCIO	6 mm CONTEMPORANEI SKYLINE BEIGE	6 mm CONTEMPORANEI SKYLINE FUMO	6 mm CONTEMPORANEI SKYLINE ANTRACITE	6 mm MARM TAJ MAHAL	6 mm MARM TRAVERTINO CLASSIC	6 mm MARM WHITE MACAUBA	6 mm ONICI AESTHETICA WLOE	6 mm ONICI AESTHETICA HEGEL	6 mm ONICI KANT	6 mm ONICI ONICE SERPENTINO	6 mm PIETRE E GRANITI ARDESIA	6 mm PIETRE E GRANITI C-STONE
6 mm DESIGN MILKY WAY	6 mm DESIGN ECLIPSE	6 mm DESIGN SUPERLUNA	6 mm DESIGN MOONLIGHT	6 mm DESIGN LIGHT GRAFFITI	6 mm DESIGN DARK GRAFFITI	6 mm PIETRE E GRANITI COPACABANA PRINCESS	6 mm PIETRE E GRANITI COPACABANA DUKE	6 mm PIETRE E GRANITI COPACABANA EMPEROR	6 mm PIETRE E GRANITI PIRENEI	6 mm PIETRE E GRANITI TORTOISE	6 mm PREZIOSI NAUTILUS	6 mm PREZIOSI ONICE SMERALDO	6 mm PREZIOSI PORTORO			

* Le dimensioni originali sono personalizzabili.
 Original sizes can be altered for customisation.
 Les dimensions originales sont personnalisables.
 Die Original-Abmessungen können angepasst werden.
 Las dimensiones originales son personalizables.
 Размеры могут быть приведены в соответствие с индивидуальными потребностями.

Per approfondire i dettagli tecnici consultare la scheda prodotto fornita da AVA
 For further technical details, please see the product specifications sheet provided by AVA.
 Pour approfondir les détails techniques, consulter la fiche produit fournie par AVA.
 Zur Vertiefung der technischen Details lesen Sie bitte auf dem von AVA bereitgestellten Produkt-Datenblatt nach.
 Para profundizar en los detalles técnicos sírvase consultar la ficha del producto proporcionada por AVA.
 Для более подробного изучения технических свойств смотрите технические характеристики, предоставленные компанией AVA.



PARTE TECNICA

Technical section . Partie technique . Technischer Teil . Parte técnica . Технический раздел .

FINITURE DELLE SUPERFICI.....418

Surface finishes
Finitions des Surfaces
Feinbearbeitung der Oberflächen
Acabados de las superficies
Отделки поверхностей

TANTE FACCE TUTTE DIFFERENTI.....418

Endless looks, all different
De nombreuses facettes toutes différentes
Viele verschiedene Seiten
Tantas caras, todas diferentes
Множество лиц, все разные

LA STUOIA.....419

Fiber glass mesh
La fibre de verre
Glasfasernetz
La estera
Сетка из стекловолокна

IMBALLI.....419

Package
Emballage
Verpackung
Embalajes
Упаковка

OUTDOOR 20 MM.....420

422 Outdoor 20 mm: i pezzi speciali
20 mm outdoor option: trims
Extérieur 20 mm : les pièces spéciales
Außenbereich 20 mm: die Formteile

CARATTERISTICHE TECNICHE.....424

Technical features
Caracteristiques techniques
Technische Eigenschaften
Características técnicas
Технические характеристики

CERTIFICAZIONI.....425

Certifications
Certifications
Zertifikate
Certificaciones
Сертификация

Finiture delle Superfici

Surface finishes . Finitions des Surfaces
 Feinbearbeitung der Oberflächen . Acabados de las superficies
 Отделки поверхностей

Le lastre EXTRAORDINARYSIZE sono disponibili in due generi di finitura, lappato e naturale. Due caratteri differenti che aggiungono valore estetico e pratico alle esigenze specifiche di ogni singolo progetto.

The EXTRAORDINARYSIZE slabs are available in two kinds of finish, i.e. lappato and natural. Two different moods that heighten aesthetics and offer practical answers to the specific needs of every single project.

Les dalles EXTRAORDINARYSIZE sont produites avec deux types de finitions : lappato et naturelle. Deux caractères différents qui ajoutent de la valeur esthétique et pratique aux exigences spécifiques de chaque projet.

Die Platten EXTRAORDINARYSIZE sind in zwei Ausführungen erhältlich, d.h. lappato und naturel. Zwei verschiedene Charaktere, die zu den spezifischen Erfordernissen jedes einzelnen Entwurfs ästhetischen und praktischen Wert hinzufügen.

Las losas EXTRAORDINARYSIZE están disponibles en dos tipos de acabado, lappato y natural. Dos características diferentes que agregan valor estético y práctico según los requerimientos específicos de cada proyecto.

Плиты EXTRAORDINARYSIZE могут иметь отделку двух типов: притертую и натуральную. Эти два разных характера позволяют удовлетворить особые потребности каждого отдельного проекта и сделать его эстетически привлекательным и практичным.

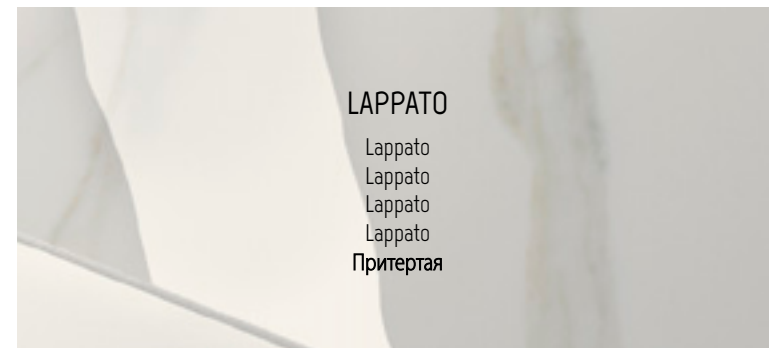

LAPPATO

Lappato
Lappato
Lappato
Lappato
Притертая



NATURALE

Natural
Naturel
Natur
Natural
Натуральная

Tante facce tutte differenti

Endless looks, all different . De nombreuses facettes toutes différentes
 Viele verschiedene Seiten . Tantas caras, todas diferentes
 Множество лиц, все разные

La gamma dei colori e dei materiali rappresentati delle lastre EXTRAORDINARYSIZE in gres porcellanato prevedono la presenza di grafiche differenti per garantire un autentico effetto naturale su grandi e piccole estensioni di superficie.

The range of colours and materials offered by EXTRAORDINARYSIZE porcelain stoneware slabs feature different graphics to create a realistic, natural feel in large and small areas.

La gamme des couleurs et des matériaux représentés concernant les dalles EXTRAORDINARYSIZE en grès cérame prévoit la présence de graphismes différents pour garantir un effet naturel authentique sur les petites et grandes surfaces.

Die Palette der durch die Platten EXTRAORDINARYSIZE aus Feinsteinzeug verkörpert Farben und Materialien sehen das Vorhandensein von unterschiedlichen Grafiken vor, um einen authentischen natürlichen Effekt auf großen und kleinen Oberflächen hervorzurufen.

La gama de los colores y de los materiales representados por las losas EXTRAORDINARYSIZE en gres porcelánico incluyen la presencia de diferentes gráficas para garantizar un auténtico efecto natural sobre grandes y pequeñas superficies.

Палитра цветов и ассортимент материалов для плит EXTRAORDINARYSIZE из керамогранита предусматривают разную графику для гарантии настоящего натурального эффекта на больших и маленьких поверхностях.

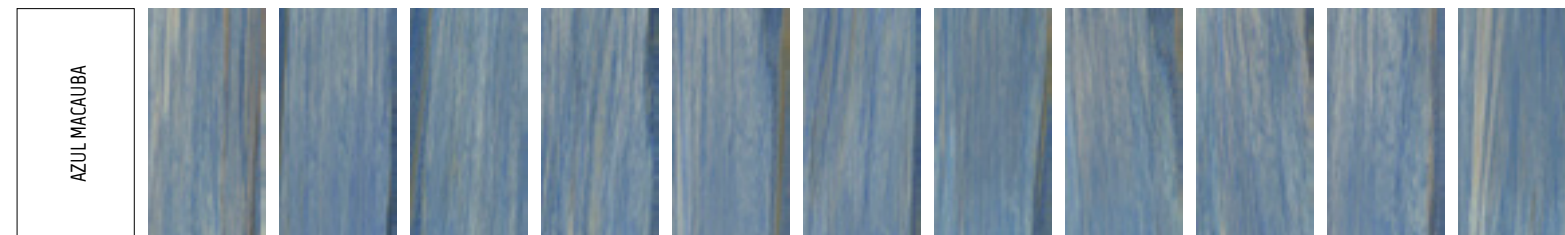

AZUL MACAUBA

La stuoia

Fiber glass mesh . La fibre de verre
 Glasfasernetz . La estera
 Сетка из стекловолокна

Per particolari applicazioni, per aumentare la resistenza meccanica al carico ed alla rottura, la lastra può essere fornita con stuoia in fibra di vetro applicata in retro.

For specific applications and in order to further increase their breaking strength, slabs can be supplied with a fiber glass mesh already fixed on their back.

En cas d'utilisations particulières, pour augmenter la résistance mécanique à la charge et à la rupture, la plaque peut être fournie avec une fibre de verre appliquée sur le dos.

Für besondere Anwendungsbereiche kann die Rückseite der Platte auch mit einem Glasfasernetz bestückt werden, um die Bruchlast und den mechanischen Widerstand zu erhöhen.

Para aplicaciones particulares y para aumentar su resistencia mecánica a carga y a rotura, la plancha puede ser suministrada con estera de fibra de vidrio aplicada en su parte trasera.

При необходимости увеличить сопротивление керамической плиты на излом, следует заказывать её с нанесённой на изнаночную сторону сеткой из стекловолокна.

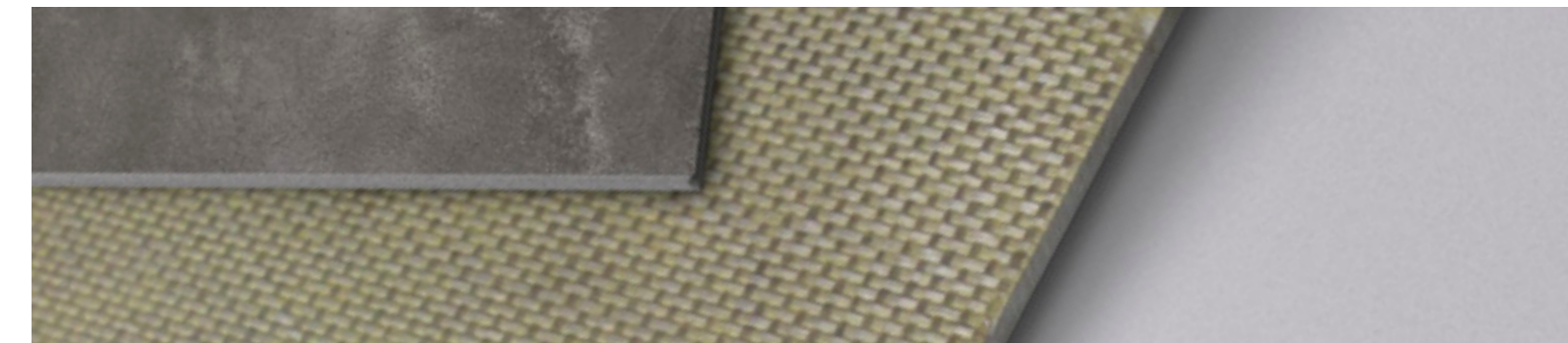

Imballi

Package . Emballage
 Verpackung . Embalajes
 Упаковка

CASSA
Crate



Formato lastre . Size slabs
320x160

Formato lastre . Size slabs
240x120

Formato lastre . Size slabs
160x160

Formato lastre . Size slabs
280x120

CAVALLETTO IN LEGNO
Wood A-Frame



Formato lastre . Size slabs
320x160
160x160
280x120

Formato lastre . Size slabs
240x120
120x120

CAVALLETTO IN FERRO
Iron A-Frame



Formato lastre . Size slabs
324x163 12mm

PALLET SPONDE ALTE
High - Sided pallets



Formato lastre . Size slabs
120x120
100x100

Formato lastre . Size slabs
160x80

20 mm

SPESORE
THICKNESS
ÉPAISSEUR
STÄRKE

R11-C

Naturale e rettificato.
Natural and rectified.
Naturel et rectifié.
Natur Oberfläche und kalibriert.



Outdoor 20 mm

Gres porcellanato colorato in massa . Colored body porcelain stoneware . Grès cérame coloré dans la masse . Eingefärbtes Feinsteinzeug

PROGETTARE CON PIASTRELLE DI SPESORE 20 MM SIGNIFICA UTILIZZARE UN PROGRAMMA DI PAVIMENTAZIONI CON FUNZIONALITÀ EVOLUTE E SPECIFICHE PER L'ESTERNO.

Lo spessore aumentato consente maggiore versatilità di posa e si adatta alla differente natura del letto di fondo sia esso su erba, su ghiaia o su sabbia.

La grande resistenza ai carichi di rottura consente inoltre di realizzare superfici carrabili o pavimentazioni sopraelevate che grazie a specifici supporti rendono possibile l'alloggiamento di impianti elettrici o di irrigazione.

Le caratteristiche delle collezioni di AVA esprimono tutte le potenzialità estetiche e tecniche sia in ambienti domestici che pubblici.

DESIGNING WITH 20 MM-THICK FLOORING/PAVING TILES MEANS USERS CAN MAKE USE OF A RANGE OF ADVANCED FEATURES DEVISED SPECIFICALLY FOR OUTDOOR USE.

The increased thickness means greater laying versatility and that the material adapts to the various different bases, such as grass, gravel or sand.

The high ultimate strength also allows users to create driveways or raised floors with specific pedestals and underfloor cavities that can house electrical wiring or irrigation systems.

The characteristics of AVA's collections cover all the potential design and technical requirements that could be found in both homes and public spaces.

PREVOIR DES CARREAUX DE 20 MM D'ÉPAISSEUR SIGNIFIE UTILISER UN PROGRAMME DE REVÊTEMENT AUX FONCTIONS ÉVOLUÉES ET SPÉCIFIQUES POUR L'EXTÉRIEUR.

Une épaisseur plus importante permet d'obtenir davantage de flexibilité de pose et s'adapte à la nature différente du sol, qu'il s'agisse d'herbe, de gravier ou bien de sable.

La haute résistance aux charges de rupture permet également de réaliser des surfaces carrossables ou des revêtements surélevés qui, grâce à des supports spécifiques, permettent de loger les circuits électriques ou d'irrigation.

Les caractéristiques des collections de AVA expriment toutes les potentialités esthétiques et techniques si bien dans les espaces domestiques que publics.

MIT 20 MM-PLATTEN FLIESEN, BEDEUTET EIN PROGRAMM AN BODENBELÄGEN ZU VERWENDEN, DAS HOCHENTWICKELTE UND SPEZIELL FÜR AUSSENBEREICHE GEEIGNETE FUNKTIONALITÄTEN AUFWEIST.

Die größere Stärke schafft eine größere Verlegevielseitigkeit und passt sich an die unterschiedlichen Ausführungen des Unterbodens, wie Gras, Kies oder Sand, an.

Aufgrund der hohen Bruchlastfestigkeit können befahrbare Flächen oder Doppelböden geschaffen werden, die dank ihrer besonderen Abstützungen für die Aufnahme von Elektro- oder Bewässerungsanlagen geeignet sind.

Die Merkmale der AVA-Kollektionen entfalten sowohl in Wohnräumen als auch in öffentlichen Umgebungen ihre gesamten ästhetischen und technischen Potentialitäten.

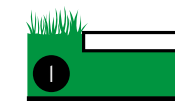
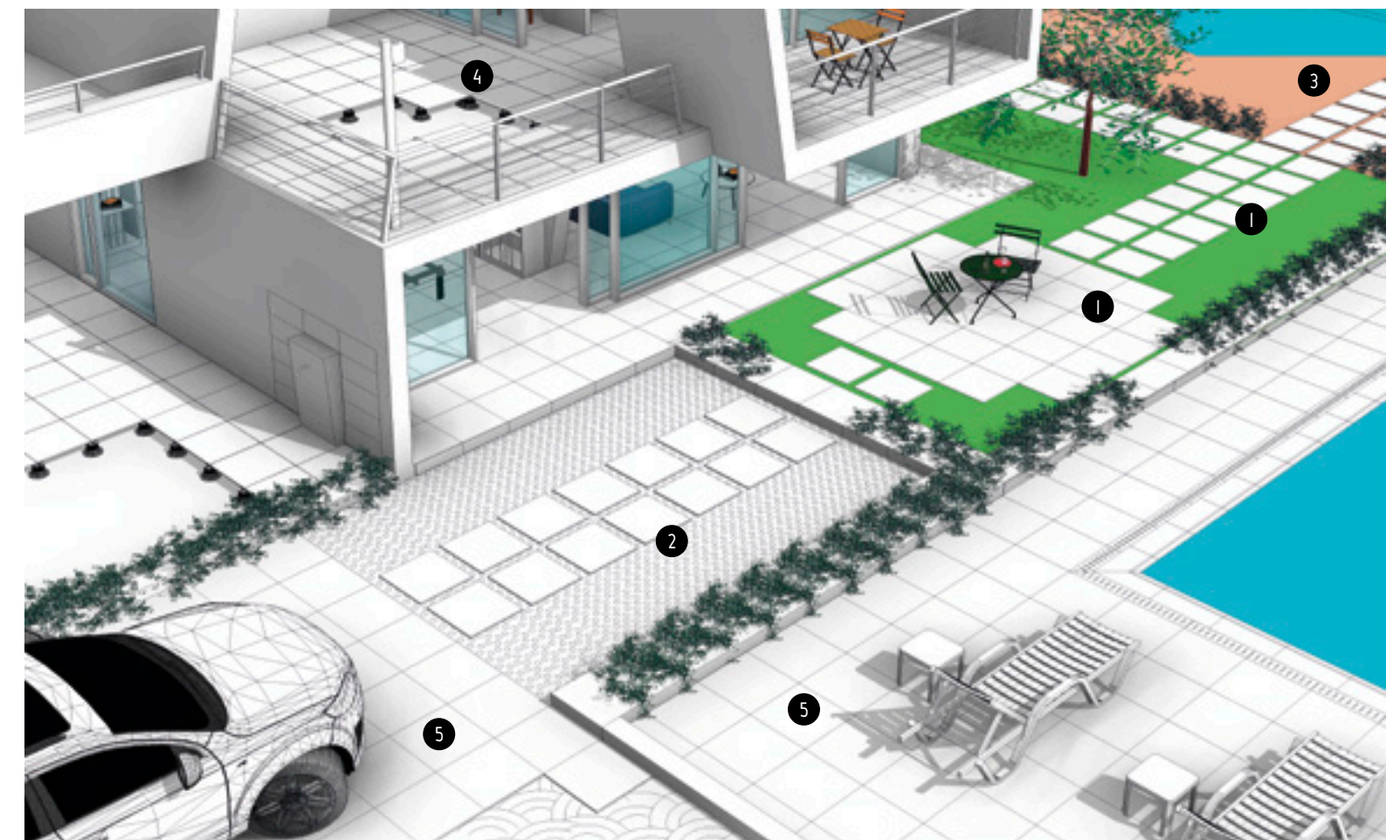

Posa a secco su erba
Dry installation on grass
Pose à sec sur l'herbe
Trockenverlegung auf Gras

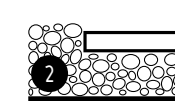

Posa a secco su ghiaia
Dry installation on gravel
Pose à sec sur gravier
Trockenverlegung auf Kies

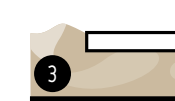

Posa a secco su sabbia
Dry placement on sand
Pose à sec sur la sable
Trockenverlegung auf Sand

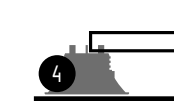

Pavimento sopraelevato
Raised installation
Pose surélevée
Stelzverlegung

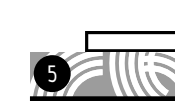

Posa a colla tradizionale
Traditional laying with glue
Pose à colle traditionnelle
Verlegung mit Kleber

Outdoor 20 mm: i pezzi speciali



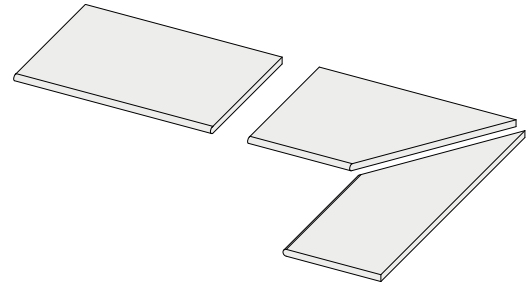

20 mm outdoor option: trims
 Extérieur 20 mm : les pièces spéciales
 Außenbereich 20 mm: die Formteile

Swimmingpool & Outdoor - RII-C

GRADONE BORDO . Large step . Nez de marche avec bord . Stufenplatten . Placa borde . Большая ступень .



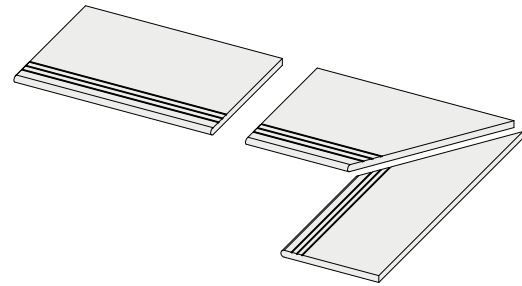

Gradone bordo 40 / 30 / 15
 Large step 40 / 30 / 15
 Nez de marche avec bord 40 / 30 / 15
 Stufenplatten 40 / 30 / 15
 Placa borde 40 / 30 / 15
 Большая ступень 40 / 30 / 15

40x120 . 16"x48" | 30x60 . 12"x24" | 15x60 . 6"x24"
 40x80 . 16"x31 1/2" |   |  



Gradone bordo grip
 Large step with anti-slip border.
 Nez de marche avec antidérapant.
 Stufenplatten gerillt.
 Placa borde antideslizamiento.
 Большая ступень с нескользким бортом.

40x120 . 16"x48" | 40x80 . 16"x31 1/2" | 30x60 . 12"x24"
 

Swimmingpool & Outdoor - RII-C

GRIGLIE . Drainage grid . Drainage grille . Rinnenabdeckung . Rejilla . Решетки .

Griglia 30 / 20 / 15
 Drainage grid 30 / 20 / 15
 Drainage grille 30 / 20 / 15
 Rinnenabdeckung 30 / 20 / 15
 Rejilla 30 / 20 / 15
 Решетка 30 / 20 / 15

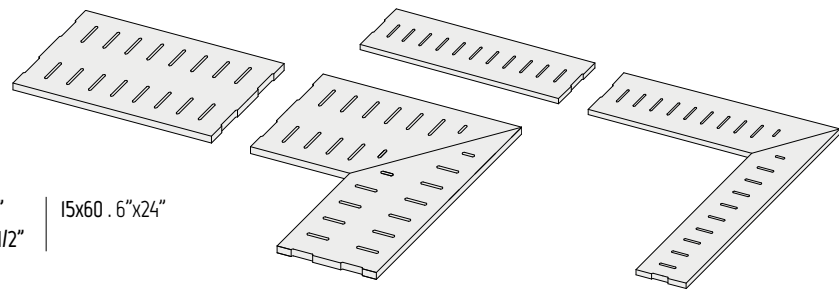

30x60 . 12"x24" | 20x60 . 8"x24" | 15x60 . 6"x24"
 20x80 . 8"x31 1/2" |

TOP GOCCIOLATOIO . Drip cap . Plaque supérieure égouttement .
 Zufälliger grafischer Entwurf (Technologie mit Rolle) . Top canalón . Одинарная верхняя плита .

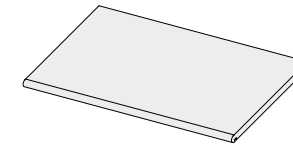

*
Copertina / Gocciolatoio singolo
 Cover / single drip cap.
 Couverture / unique égouttoir.
 Abdeckplatte mit Wassernase.
 Cubierta/Canalón singular.
 Верхняя плита с одним отливом

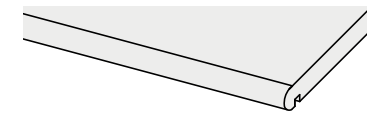

30x60 . 12"x24"

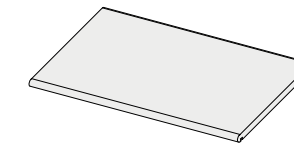

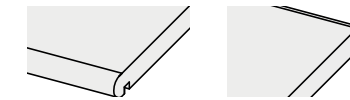

*
Copertina / Gocciolatoio doppio
 Cover / double drip cap
 Couverture / double égouttoir
 Abdeckplatte mit Wassernase doppelt
 Cubierta/Canalón doble.
 Верхняя плита с двумя отливками



30x60 . 12"x24"

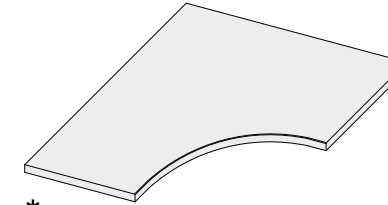

PER BORDURE E AIUOLE . For borders and flower beds . Pour bordures et parterres .
 Für Borde und Rabatten . Para bordes y parterres . Для бордюров и клумб .



*
Angolo curvilineo 30
 Curve-shaped corner 30
 Angle arrondi 30
 Innenecke 30
 Ángulo curvilíneo 30
 Закругленный угол 30

60x60 . 24"x24"

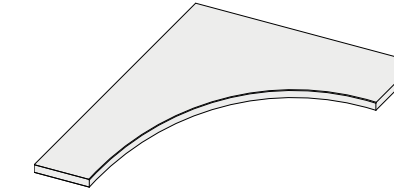
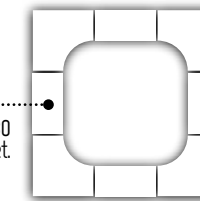
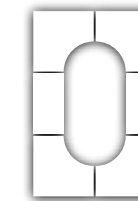
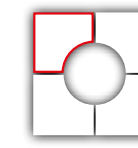

GRADONE BORDO 30
 30x60 . 12"x24" Nat. Ret.



*
Angolo curvilineo 15
 Curve-shaped corner 15
 Angle arrondi 15
 Innenecke 15
 Ángulo curvilíneo 15
 Закругленный угол 15

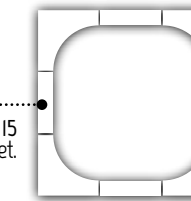
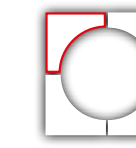

60x60 . 24"x24"



GRADONE BORDO 15
 15x60 . 6"x24" Nat. Ret.



ATTENZIONE: Per particolari installazioni potrebbero essere necessari articoli ed accessori specifici non presenti in questo catalogo. Per queste esigenze prego riferirsi direttamente al referente commerciale La Fabbrica.
 N.B. Particular items and accessories not listed in this catalogue may be required for certain laying methods. For these needs, please contact the La Fabbrica sale sales directly.
ATTENTION: Pour les installations particulières, certains articles et accessoires particuliers qui ne sont pas indiqués dans ce catalogue pourraient être nécessaires. Dans ces cas-là, nous vous prions de vous référer directement à la référence commerciale La Fabbrica.
ACHTUNG: Für besondere Installationen können besondere Artikel oder Sonderzubehör notwendig sein, die nicht im vorliegenden Katalog aufgeführt sind. Wenden Sie sich bitte in diesen Fällen direkt an den Vertrieb von La Fabbrica.
ATENCIÓN: para instalaciones particulares podrían requerirse artículos y accesorios específicos que no están presentes en este catálogo. Para tales casos rogamos contactar directamente al representante comercial de La Fabbrica.
ВНИМАНИЕ: Для особых применений могут быть необходимы специальные артикулы и аксессуары, не представленные в данном каталоге. По поводу этих вопросов просим вас обращаться непосредственно к менеджеру коммерческого отдела компании La Fabbrica.

* **PEZZI SPECIALI** - A disposizione solo su richiesta. Tempi di consegna: 30gg.
 TRIMS - Available upon request only. Delivery terms: 30 days.
 PIÈCES SPECIALES - Disponible seulement sur requête. Délais de livraison: 30 jours.
 FORMSTÜCKE - Verfügbar auf Anfrage. Lieferzeit: 30 Tage.
 PIEZAS ESPECIALES - Disponible sólo bajo pedido. Plazo de entrega: 30 días.
 СПЕЦИАЛЬНЫЕ ЭЛЕМЕНТЫ - Изготавливается только по специальной заявке. Срок поставки: 30 дней.

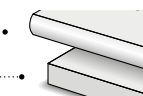
 **Costa toro** . Bullnose edge . Bord boudin . Abgerundete Kante . Canto redondo . Закругленная кромка
 **Costa retta** . Straight edge . Bord droit . Gerade Kante . Canto recto . Прямоугольная кромка



Caratteristiche tecniche















Technical features . Caracteristiques techniques.
Technische eigenschaften . Características técnicas . Технические характеристики .

LASTRE IN GRES PORCELLANATO PRESSATE A SECCO.

Dry-pressed porcelain stoneware slabs.
Dalles en grès cérame pressées à sec.
Trockengepresste Platten aus Feinsteinzeug.
Planchas en gres porcelánico prensadas en seco.
Керамогранитные плиты сухого прессования.

Classificazione secondo UNI EN 14411-ISO 13006 - G - Bla (E ≤ 0,5%) UGL

Product in compliance with UNI EN 14411-ISO 13006 - G - Bla (E ≤ 0,5%) UGL.
Classement selon UNI EN 14411-ISO 13006 - G - Bla (E ≤ 0,5%) UGL.
Klassifizierung nach UNI EN 14411-ISO 13006 - G - Bla (E ≤ 0,5%) UGL.
Clasificación según UNI EN 14411-ISO 13006 - G - Bla (E ≤ 0,5%) UGL.
Классификация согласно европейской сертификации UNI EN 14411-ISO 13006 - G - Bla (E ≤ 0,5%) UGL.

	CARATTERISTICA SPECIFICATION CARACTERISTIQUE EIGENSCHAFT CARACTERÍSTICA СПЕЦИФИКА	METODO DI PROVA TEST METHODS METHODE D'ESSAI TESTVERFAHREN PRUEBA СТАНДАРТ ИСПЫТАНИЙ	VALORE PRESCRITTO FIXED VALUE VALEUR PRESCRITE VORGESCHRIEBENER WERT VALOR PRESCRITO ТРЕБОВАЕМОЕ ЗНАЧЕНИЕ	
	CARATTERISTICHE DIMENSIONALI DIMENSIONAL CHARACTERISTICS DIMENSIONS DIMENSIONALE EIGENSCHAFTEN CARACTERÍSTICAS DIMENSIONALES ПРОСТРАНСТВЕННЫЕ ХАРАКТЕРИСТИКИ	ISO 10545-2		CONFORME COMPLIANT CONFORME ERFÜLLT CUMPLE СОТВЕТСТВУЕТ
	ASSORBIMENTO D'ACQUA WATER ABSORPTION ABSORPTION D'EAU WASSERAUFNAHME ABSORCIÓN DE AGUA ВОДОПОГЛАЩЕНИЕ	ISO 10545-3	≤ 0,5 %	CONFORME COMPLIANT CONFORME ERFÜLLT CUMPLE СОТВЕТСТВУЕТ
	RESISTENZA ALLA FLESSIONE BREAKING MODULUS RESISTANCE A LA FLEXION BIEGEFESTIGKEIT RESISTENCIA A LA FLEXIÓN ПРОЧНОСТЬ НА ИЗГИБ		≥ 35 N/mm ²	CONFORME COMPLIANT CONFORME ERFÜLLT CUMPLE СОТВЕТСТВУЕТ
	SFORZO DI ROTTURA MODULUS OF RUPTURE CHARGE DE RUPTURE BRUCHLAST ESFUERZO DE ROTURA СТОЙКОСТЬ НА ИЗГИБ	ISO 10545-4	≥ 7,5 mm = ≥ 1300 N < 7,5 mm = ≥ 700 N	CONFORME COMPLIANT CONFORME ERFÜLLT CUMPLE СОТВЕТСТВУЕТ
	RESISTENZA ALLA ABRASIONE PROFONDA DEEP ABRASION RESISTANCE RESISTANCE A L'ABRASION PROFONDE BESTÄNDIGKEIT GEGEN TIEFENVERSCHEISS RESISTENCIA A LA ABRASION PROFUNDA УСТОЙЧИВОСТЬ К ГЛУБОКОМУ СТИРАНИЮ ПО	ISO 10545-6	≤ 175 mm ³	CONFORME COMPLIANT CONFORME ERFÜLLT CUMPLE СОТВЕТСТВУЕТ
	COEFFICIENTE DI DILATAZIONE TERMICA LINEARE THERMAL EXPANSION COEFFICIENT COEFFICIENT DE DILATATION THERMIQUE LINEAIRE WARMEAUSENDNUNGSKOEFFIZIENT COEFFICIENTE DE DILATACION TERMICA LINEAL КОЭФФИЦИЕНТ ТЕПЛООВОГО ЛИНЕЙНОГО РАСТЯЖЕНИЯ	ISO 10545-8	METODO DISPONIBILE AVAILABLE ON REQUEST METHODE DISPONIBLE VERFÜGBARES VERFAHREN MÉTODO DISPONIBLE ОПРЕДЕЛЯЕТСЯ ПРОИЗВОДИТЕЛЕМ	≤ 7x10 ⁻⁶ °C ⁻¹
	RESISTENZA AGLI SBALZI TERMICI THERMAL SHOCK RESISTANCE RESISTANCE AUX ECARTS DE TEMPERATURE TEMPERATURWECHSELBESTÄNDIGKEIT RESISTENCIA A CHOQUE TÉRMICO УСТОЙЧИВОСТЬ К ТЕМПЕРАТУРНЫМ ПЕРЕПАДАМ	ISO 10545-9	METODO DISPONIBILE AVAILABLE ON REQUEST METHODE DISPONIBLE VERFÜGBARES VERFAHREN MÉTODO DISPONIBLE ОПРЕДЕЛЯЕТСЯ ПРОИЗВОДИТЕЛЕМ	RESISTENTI RESISTANT RESISTANTS WIDERSTANDSFÄHIG RESISTE УСТОЙЧИВЫ
	RESISTENZA AL GELO FROST RESISTANCE RESISTANCE AU GEL FROSTBESTÄNDIGKEIT RESISTENCIA AL HIELO МОРОЗОСТОЙКОСТЬ	ISO 10545-12	RICHIESTA ALWAYS TESTED EXIGEE NOTWENDIG PRECIDO ТРЕБОВАНИЯ	RESISTENTI RESISTANT RESISTANTS WIDERSTANDSFÄHIG RESISTE УСТОЙЧИВЫ
	RESISTENZA AI PRODOTTI CHIMICI CHEMICAL RESISTANCE RESISTANCE AUX PRODUITS CHIMIQUES CHEMISCHE BESTÄNDIGKEIT RESISTENCIA A LOS PRODUCTOS QUIMICOS ХИМИЧЕСКАЯ УСТОЙЧИВОСТЬ	ISO 10545-13	min. UB	RESISTENTI RESISTANT RESISTANTS WIDERSTANDSFÄHIG RESISTE УСТОЙЧИВЫ
	PRODOTTI CHIMICI AD USO DOMESTICO ED ADDITIVI PER PISCINA HOUSEHOLD CHEMICALS AND SWIMMING POOL WATER CLEANSERS PRODUITS CHIMIQUES COURANTS ET ADDITIFS POUR PISCINE CHEM.PRODUKTE FÜR DEN HAUSHALTSGEBRAUCH UND ZUSATZ FÜR SCHWIMMBÄDER PRODUCTOS QUIMICOS PARA USO DOMÉSTICO Y CON ADITIVOS PARA PISCINA Бытовые химические средства и средства для бассейнов			
	ACIDI ED ALCALI A BASSA CONCENTRAZIONE ACIDS AND LOW CONCENTRATION ALKALIS ACIDES ET ALCALI A FAIBLE CONCENTRATION SÄUREN UND ALKALI IN GERINGER KONZENTRATION ÁCIDOS Y ALCALIS EN BAJA CONCENTRACION низкоконцентрированные кислоты и щелочи			
	RESISTENZA ALLE MACCHIE STAIN RESISTANCE RESISTANCE AUX TACHES FLECKBESTÄNDIGKEIT RESISTENCIA A LAS MANCHAS УСТОЙЧИВОСТЬ К ЗАГРЯЗНЕНИЮ	ISO 10545-14	METODO DISPONIBILE AVAILABLE ON REQUEST METHODE DISPONIBLE VERFÜGBARES VERFAHREN MÉTODO DISPONIBLE ОПРЕДЕЛЯЕТСЯ ПРОИЗВОДИТЕЛЕМ	RESISTENTI RESISTANT RESISTANTS WIDERSTANDSFÄHIG RESISTE УСТОЙЧИВЫ
	STABILITÀ DEI COLORI ALLA LUCE COLOUR STABILITY TO LIGHT STABILITÉ DES COULEURS A LA LUMIERE LICHTSTICHHEIT DER FARBEN ESTABILIDAD DE LOS COLORES УСТОЙЧИВОСТЬ ЦВЕТА	DIN 51094	METODO DISPONIBILE AVAILABLE ON REQUEST METHODE DISPONIBLE VERFÜGBARES VERFAHREN MÉTODO DISPONIBLE ОПРЕДЕЛЯЕТСЯ ПРОИЗВОДИТЕЛЕМ	CONFORME COMPLIANT CONFORME ERFÜLLT CUMPLE СОТВЕТСТВУЕТ
	COEFFICIENTE DI ATTRITO (SCIVOLosità) FRICTION COEFFICIENT (SLIPPERINESS) COEFFICIENT DE FROTTEMENT (GLISSANCE) REIBUNGSKOEFFIZIENT (GLÄTTE) - COEFFICIENTE DE FRICCION (DESIZABILIDAD) КОЭФФИЦИЕНТ ТРЕНИЯ (СКОЛЬЗКОСТЬ)	ANSI A 137.1:2012	≥ 0,42	≥ 0,42 SUPERFICIE NATURALE NATURAL SURFACE

Certificazioni di prodotto

Product certification . Certification de produit .
Produkt Zertifizierungen . Certificaciones de producto . Сертификация .

Attestazione della percentuale di riciclato, Dichiarazione Ambientale di prodotto settoriale, UPEC, Marchio CCC, Marcatura CE, Certificazione VOC-COV, Conformità Bielorussia, Conformità Egitto ES 3168-2/2015

Certificate of percentage of recycled material, Industry-specific Environmental Product Declaration, UPEC, CCC mark, CE marking, VOC certification, Compliance for Byelorussia, Compliance for Egypt ES 3168-2/2015

Attestation du pourcentage de matériel recyclé, Déclaration environnementale de produit sectoriel, UPEC, Label CCC, Marquage CE, certification VOC-COV, conformité Biélorussie, conformité Égypte ES 3168-2/2015

Bescheinigung des Anteils von Recycling-Produkten, Umweltschutz-Erklärung der Produkte nach Bereichen, UPEC, CCC-Kennzeichnung, CE-Kennzeichnung, VOC-COV-Zertifizierung, Konformität für Weißrussland, Ägypten ES 3168-2/2015

Certificación del porcentaje de reciclado, Declaración Ambiental de producto sectorial, UPEC, Marcación CCC, Marcación CE, Certificación VOC-COV, Conformidad Bielorussia, Conformidad Egipto ES 3168-2/2015

Сертификат процентного содержания переработанного материала, отраслевая экологическая декларация продукции, сертификат UPEC, знак CCC, маркировка CE, сертификат ЛОС, сертификат соответствия РБ, египетский сертификат соответствия ES 3168-2/2015

100% DESIGN
AND PRODUCTION
OF ITALY



“Ceramics of Italy”



放射性水平 A 类



Tutte le lastre sono certificabili MOCA.
All the slabs can be MOCA-certified.
Toutes les dalles sont certifiées MOCA.
Alle Platten sind nach MOCA zertifizierbar.
Todas las planchas pueden ser certificadas MOCA.
Все плиты могут иметь сертификат MOCA.



SKYLINE

Certificazioni di sistema

System certification . Certifications du système .
Systemzertifikationen . Certificaciones de sistema . Системная сертификация

ISO 14001:2015, EMAS, ISO 50001:2015, ISO 9001:2015, ISO 45001:2018, OHSAS 18001:2007, Good Phytosanitary practices



UNI EN ISO 9001:2015

CONSULTA IL SITO WWW.AVACERAMICA.IT PER VEDERE GLI ULTIMI AGGIORNAMENTI.
CHECK OUT OUR WEBSITE AT WWW.AVACERAMICA.IT FOR THE LATEST UPDATES.
CONSULTEZ LE SITE WWW.AVACERAMICA.IT POUR CONNAÎTRE LES DERNIÈRES MISES À JOUR.
AUF DER WEBSITE WWW.AVACERAMICA.IT FINDEN SIE DIE NEUESTEN INFORMATIONEN.
CONSULTA EL SITO WWW.AVACERAMICA.IT PARA VER LAS ÚLTIMAS ACTUALIZACIONES.
ЗАЙДИТЕ НА САЙТ WWW.AVACERAMICA.IT, ЧТОБЫ УВИДЕТЬ ПОСЛЕДНИЕ НОВИНКИ.

AD: **OMNIADVERT S.P.A.**
MARKETING LA FABBRICA
PRINT: **LITO GROUP SRL**
EDIZIONE I - FEBBRAIO 2021

La Fabbrica S.p.A. si riserva di apportare, senza alcun preavviso, le modifiche che riterrà più opportune al fine di migliorare il prodotto.
Quanto riportato è da considerarsi indicativo e non esaustivo in riferimento ai colori e alle caratteristiche estetiche dei prodotti.

La Fabbrica S.p.A. reserves the right to make any changes it deems fit in order to improve the product, without prior notice.
All images are provided for illustrative purposes only and other colours and aesthetic features are available.

La Fabbrica S.p.A. se réserve le droit d'apporter, sans préavis, les modifications qu'elle jugera opportunes afin d'améliorer le produit.
Les informations ci-dessus sont fournies à titre indicatif et elles ne sont pas contraignantes en ce qui concerne les couleurs et les caractéristiques esthétiques des produits.

Die Firma La Fabbrica S.p.A. behält sich vor, ohne jegliche vorherige Ankündigung jene Änderungen vorzunehmen, die sie zur Verbesserung des Produktes für angebracht hält.
Die Angaben sind bezüglich der Farben und ästhetischen Eigenschaften der Produkte als Richtwerte und nicht als vollständig anzusehen.

La Fabbrica S.p.A. se reserva la posibilidad de introducir, sin obligación de aviso previo, las modificaciones que considere más indicadas para mejorar el producto.
Las cualidades del material presentado deben considerarse de modo genérico, no siendo exhaustivas en cuanto a los colores y a las características estéticas de los productos.

La Fabbrica S.p.A. оставляет за собой право на внесение без предварительного уведомления изменений, которые она считает целесообразными для улучшения продукции.
Приведенные указания должны считаться ориентировочными и не исчерпывающими в том, что касается цветов и эстетических характеристик продукции.



